

2 0 2 4 - 2 0 2 5

revigres

G E N E R A L C A T A L O G U E

CATÁLOGO GERAL · CATALOGUE GÉNÉRAL · CATÁLOGO GENERAL

2 0 2 4 - 2 0 2 5

revigres

ÍNDICE GERAL

GENERAL INDEX · INDEX GÉNÉRALE · ÍNDICE GENERAL

Produtos Revigrés 006
Revigrés Products
Produits Revigrés
Productos Revigrés

Histórias que Revestem o Mundo 008
The Art of Storytelling
Des Histoires Qui Revetent Le Monde
Historias que Revisten el Mundo

Design & Inovação 012
Design & Innovation
Design & Innovation
Diseño & Innovación

A nossa Cerâmica é Verde 014
Our Tiles are Green
Notre Céramique est Verte
Nuestra Cerámica es Verde

Um toque Português 016
A Portuguese touch
Une Touche Portugaise
Un toque Portugués

Qualidade Global 018
Global Quality
Qualité Globale
Calidad Global

Um Parceiro para o seu Projeto 020
A Partner for your Project
Un Partenaire pour votre Projet
Un Socio para su Proyecto

Decorados e Barras 365
Decors and Bars
Decors et Bandes
Decorados y Barras

Informações Úteis 374
Useful Information
Informations Utiles
Información Útil

COLEÇÕES COLLECTIONS COLLECTIONS COLECCIONES

Absolut Black 314
Arizona 274
Baltic Grey 310
Brick · NEW 108
Block · NEW 109
Bold 160
Calacatta Bianco 326
Calacatta Classic · NEW 276
Calacatta Oro 318
Chic 138
Cityzen · NEW 188
Copper 100
Cromática 024
Deck 350
Deck Forest 362
Di Alba Stone 248
Ecotech 084
Elements 196
Edicer Pedralva 278
Emperador Brown 306
Ethos 142
Flick 160
Flint 070
Forest 360
French Stone 246
Hydraulic 212
Iron 102

Jinko 344
Lavastone · NEW 232
Limestone · NEW 220
Locus 178
Mix Reliefs 164
Montana 354
Neutral 150
Nordik 334
Omni 052
Omnistone 062
Onix Gold 300
Pigmento 078
Quilt 186
Rainforest Green 292
Reflex · NEW 094
Retro 116
Revival 120
Rule · NEW 170
Saturno 088
Silken 214
Slate 252
Statuario White · NEW 286
Travertino Classic · NEW 228
Unicolor 124
Unite 146
Urban · NEW 204
Xisto 258

CORES COLOURS COULEURS COLORES

 24, 116, 120

 24, 108, 112, 116, 120, 160

 24, 52, 62, 70, 78, 108, 112, 116, 120, 124, 146, 150, 160, 178, 188, 196, 204, 214, 220, 228, 232, 246, 258, 266, 270, 354, 360, 362

 24, 108, 112, 116, 120, 124, 138, 142, 160, 164, 258

 24, 52, 62, 100, 204, 232, 252, 258, 306, 334, 345, 350, 354, 360, 362

 24, 52, 62, 70, 78, 84, 88, 102, 116, 120, 124, 146, 150, 160, 170, 178, 188, 196, 204, 214, 232, 240, 246, 252, 266, 270, 276, 286, 310, 326, 334, 345, 350

 94, 146, 300, 318

 94, 146

 24, 52, 62, 70, 84, 94, 108, 112, 124, 138, 142, 258, 314

 24, 116, 120, 160

 24, 94, 108, 112, 116, 120, 160, 292

 24, 94, 108, 112, 116, 120, 146, 160, 166, 350

ÍNDICE POR ESTILO

INDEX BY STYLE · INDEX PAR EFFET · ÍNDICE POR ESTILO

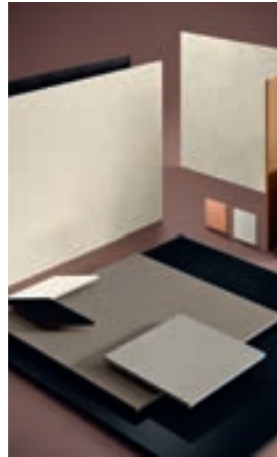

FULL-BODY

Cromática	024
Omni	052
Omnistone	062
Flint	070
Pigmento	078

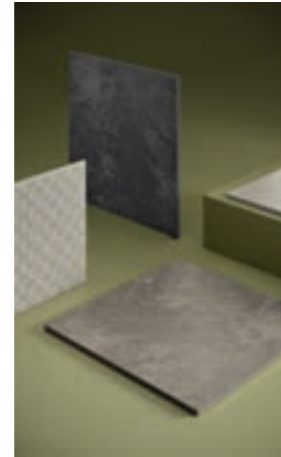

ECOTILES

Ecotech	084
Saturno	088

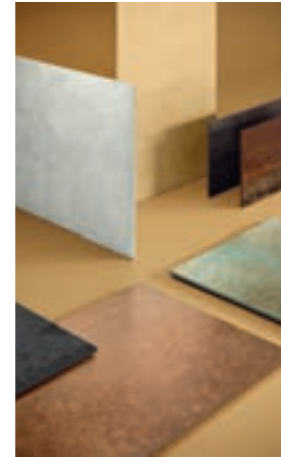

METALLIC

Reflex · NEW	094
Copper	100
Iron	102



COLOURS

Brick · NEW	108
Block · NEW	109
Retro	116
Revival	120
Unicolor	124



RELIEFS

Chic	138
Ethos	142
Unite	146
Neutral	156
Bold · Flick	160
Mix Reliefs	164



CONCRETE

Rule · NEW	170
Locus · Quilt	178
Cityzen · NEW	188
Elements	196
Urban · NEW	204
Hydraulik	212
Silken	214



STONES

Limestone · NEW	220
Travertino Classic · NEW	228
Lavastone · NEW	232
Di Alba Stone	240
French Stone	246
Slate	252
Xisto	258
Arizona	266
Edicer Pedralva	270

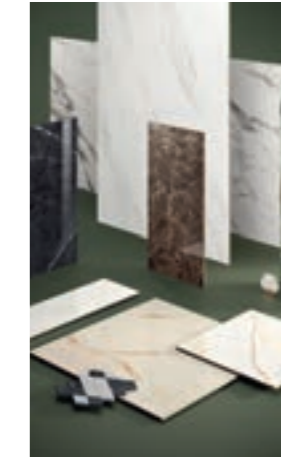

MARBLES

Calacatta Classic · NEW	276
Statuario White · NEW	286
Rainforest Green	292
Onix Gold	300
Emperador Brown	306
Baltic Grey	310
Absolut Black	314
Calacatta Oro	318
Calacatta Bianco	326



WOOD

Nordik	334
Jinko	344
Deck	350
Montana	354
Forest	360
Deck Forest	362

THE ART OF INSPIRING A SUSTAINABLE FUTURE

HISTÓRIAS QUE REVESTEM O MUNDO

Viaje até um espaço e tempo em que todas as ideias e todos os projetos são passíveis de ser sonhados e concretizados com as soluções cerâmicas da Revigrés, desenvolvidas com foco no design, na inovação e na sustentabilidade, para escrever as histórias do futuro.

CROMÁTICA 3.0 MAIS DO QUE COR, COR COM PROPÓSITO.

Com 30 cores, 10 formatos e 3 acabamentos, a edição 3.0 da Coleção Cromática é uma versão adaptada ao contexto atual que aspira - e inspira - à criação de ambientes únicos e sustentáveis, através de soluções cerâmicas de design tecnicamente avançadas e diferenciadoras.

Uma paleta de 30 cores alinhadas com as reais necessidades dos profissionais e com as preferências do cliente final: tons menos saturados e mais naturais - em que se destacam os dois novos tons, Toffee e Lagoon - e materiais mais sustentáveis, duráveis e eficientes.

THE ART OF STORYTILING

Travel to a place and time where all ideas and projects can be dreamt and fulfilled with Revigrés ceramic solutions, focusing on design, innovation and sustainability to write future stories.

CROMÁTICA 3.0 MORE THAN COLOUR, COLOUR WITH PURPOSE.

Available in 30 colours, 10 sizes and 3 finishes, the 3rd edition of the Cromática Collection is a contemporary version that aspires - and inspires - to design unique and sustainable environments, through technically advanced and differentiating ceramic solutions.

Thirty trendy colours to meet the real needs of professionals and end customers' preferences: less saturated and more natural shades - with two new colours, Toffee and Lagoon - and more sustainable, durable and efficient materials.

DES HISTOIRES QUI HABILLEN LE MONDE

Voyagez dans un espace et un temps où toutes les idées et tous les projets peuvent être rêvés et réalisés avec les solutions céramiques Revigrés, en mettant toujours en avant le design, l'innovation et la durabilité pour écrire les histoires du futur.

CROMÁTICA 3.0. PLUS QUE DE LA COULEUR, DE LA COULEUR AVEC DE L'AMBIITION.

Avec 30 coloris, 10 formats et 3 finitions, l'édition 3.0 de la Collection Cromática est une version adaptée au contexte actuel qui aspire - et inspire - à la création d'ambiances uniques et durables, grâce à des solutions céramiques de design techniquement avancées et différenciatrices.

Une palette de 30 couleurs en phase avec les besoins réels des professionnels et avec les préférences du client final : des tonalités moins saturées et plus naturelles - dans lesquels se démarquent les deux nouvelles tonalités : Toffee et Lagoon - et des matériaux plus durables, plus résistants et plus efficaces.

HISTORIAS QUE REVISTEN EL MUNDO

Viaje a un espacio y tiempo futuros, en el que se pueden soñar y materializar todas las ideas y proyectos con las soluciones cerámicas de Revigrés, siempre centradas en el diseño, en la innovación y la sostenibilidad para escribir las historias del futuro.

CROMÁTICA 3.0 MÁS QUE COLOR, COLOR CON PROPÓSITO.

La edición 3.0 de la colección Cromática, con 30 colores, 10 formatos y 3 acabados, es una versión adaptada al contexto actual que aspira -e inspira- a la creación de espacios únicos y sostenibles, a través de soluciones cerámicas de diseño técnicamente avanzadas y diferenciadoras.

Una paleta de 30 colores más alineados con las necesidades reales de los profesionales y con las preferencias del cliente final: colores menos saturados y más naturales -se han introducido dos nuevos tonos: Toffee y Lagoon- y materiales más sostenibles, duraderos y eficientes.

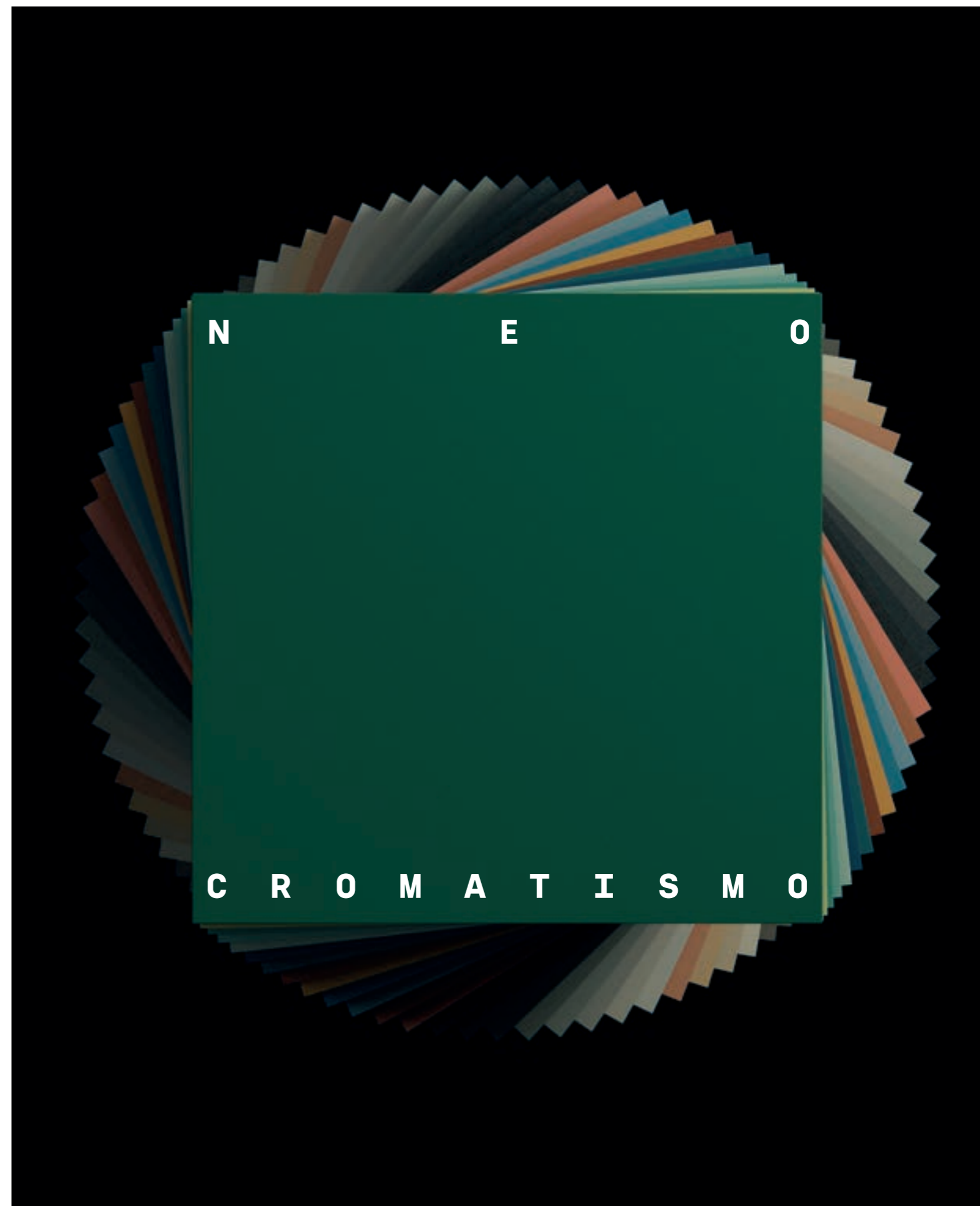

GRANDES FORMATOS E ESPESSURADOS EM GRÉS PORCELÂNICO TÉCNICO

As coleções **Light XL** – no formato 120x278cm – combinam uma espessura reduzida (6mm) com uma elevada resistência técnica, introduzindo elegância e funcionalidade nos projetos. A sua dimensão permite criar um efeito visual de continuidade através da reprodução dos materiais naturais, enquanto a sua leveza contribui para reduzir a pegada ecológica associada ao seu processo de produção e transporte e torna a sua aplicação muito versátil.

Com diversos efeitos estéticos, o novo **formato 120x120cm**, adequado para revestimento e pavimento de espaços públicos ou residenciais, completa a gama, enquanto as novas coleções Tech 20mm apresentam uma solução técnica com elevada resistência mecânica, ideal para aplicação em exteriores.

NOVAS TEXTURAS E EFEITOS

Com a tecnologia **Tech 3D** de impressão digital de última geração, a Revigrés introduz superfícies inovadoras, em que a gráfica e texturas dos materiais cerâmicos convergem na perfeição, conferindo-lhes um efeito sensorial ultrarrealista inspirado na pedra natural travertino.

Já o revivalismo do **mosaico tradicional** combinado com a versatilidade do grés porcelânico – nos formatos 14x14cm e 7x29cm – e o mood urbano e contemporâneo do **efeito metalizado** resultam em ambientes ecléticos e atuais que refletem a personalidade quem os projeta.

NOVAS SOLUÇÕES TÉCNICAS

A nova solução **PRO SYSTEM** é um pavimento sustentável e inovador, de fácil aplicação e reutilizável, adequado para pavimento sobrelevado. Uma superfície cerâmica com o efeito da madeira e antiderrapante aliada a um sistema de fixação 100% invisível que reúne todas as vantagens do grés porcelânico: durabilidade e inalterabilidade, resistência às manchas e ao desgaste, com uma elevada resistência ao impacto.

LARGE-FORMAT AND THICKENED TECHNICAL PORCELAIN TILES

The **Light XL** collections – 120x278cm – combine reduced thickness (6mm) with high technical strength, lending elegance and functionality to projects. The large tiles create a visual effect of continuity by mimicking natural materials while their lightness contributes to reducing the ecological footprint of manufacturing and transport and ensures versatile application.

Offering a range of aesthetic effects, the **new 120x120cm** wall and floor tiles for residential or public use complete our offer, while the new 20mm thick tiles provide a technical solution with high mechanical strength. Perfect for outdoor use.

NEW TEXTURES AND EFFECTS

Thanks to state-of-the-art **Tech 3D** digital printing, Revigrés introduces innovative tiles: the graphics and textures of ceramic materials converge perfectly, conveying an ultra-realistic sensory effect inspired by the Travertine natural stone.

In turn, the revival of the **traditional mosaic** combined with the versatility of porcelain tiles – 14x14cm and 7x29cm – or the urban and contemporary mood of the **metallic effect**, result in eclectic and modern environments that reflect the personality of the designers.

NEW TECHNICAL SOLUTIONS

The new **PRO SYSTEM** solution is a sustainable and innovative flooring system that is easy to apply and reuse; suitable for raised floors. A non-slip ceramic surface with the effect of wood and a 100% invisible coupling system with all the advantages of porcelain tiles: durable and stable, resistant to staining and wear, and high impact resistance.

GRANDS FORMATS ET ÉPAISSISSEMENTS EN GRÉS CÉRAME PLEINE MASSE

Les collections **Light XL** – au format 120x278cm – combinent une épaisseur réduite (6mm) avec une résistance technique élevée, en introduisant de l'élégance et de la fonctionnalité aux projets. Sa dimension permet de créer un effet visuel de continuité grâce à la reproduction de matériaux naturels, tandis que sa légèreté contribue à réduire l'empreinte écologique associée à son processus de production et de transport et rend son application très polyvalente.

Avec différents effets esthétiques, le nouveau **format 120x120cm**, qui convient aux revêtements de murs et de sols dans les espaces publics ou résidentiels, complète la gamme, tandis que les nouvelles collections Tech 20mm présentent une solution technique à haute résistance mécanique, idéale pour la pose à l'extérieur.

NOUVELLES TEXTURES ET EFFETS

Avec la technologie **Tech 3D** d'impression numérique de dernière génération, Revigrés introduit des surfaces innovantes, où les graphismes et les textures des matériaux céramiques convergent à la perfection, en leur conférant un effet sensoriel ultraréaliste inspiré de la pierre naturelle travertine.

Le retour du carrelage **traditionnel revisité** associé à la polyvalence du grés cérame – dans les formats 14x14 cm et 7x29 cm – et le mood urbain et contemporain de **l'effet métallisé**, donnent lieu à des atmosphères éclectiques et contemporaines qui reflètent la personnalité de ceux qui les conçoivent.

NOUVELLES SOLUTIONS TECHNIQUES

La nouvelle solution **PRO SYSTEM** est un revêtement de sol durable et innovant, facile à poser et réutilisable, adapté aux planchers surélevés. Une surface à effet bois antidérapant avec un système de fixation 100% invisible qui combine tous les avantages du grés cérame : durabilité et inaltérabilité, résistance aux taches et à l'usure, avec une résistance élevée aux chocs.

GRANDES FORMATOS Y ESPEORES EN GRES PORCELÁNICO TÉCNICO

Las colecciones **Light XL** – en el formato 120 x 278 cm – combinan un espesor reducido (6 mm) con una alta resistencia técnica, ofreciendo elegancia y funcionalidad a los proyectos. Con su dimensión se logra un efecto visual de continuidad a través de la reproducción de materiales naturales, en cuanto su ligereza contribuye a reducir la huella ecológica asociada al proceso de producción y transporte y hace que su aplicación sea muy versátil.

Con varios efectos estéticos, el nuevo **formato 120x120 cm**, adecuado para revestimientos y pavimentos, en espacios residenciales o públicos, completa la gama, al mismo tiempo que las nuevas colecciones Tech 20 mm presentan una solución técnica con gran resistencia mecánica, ideal para aplicar en exteriores.

NUEVAS TEXTURAS Y EFECTOS

Con la tecnología de impresión digital de última generación **Tech 3D**, Revigrés introduce superficies innovadoras, en las que los gráficos y las texturas de los materiales cerámicos convergen a la perfección, aportándoles un efecto sensorial ultrarrealista inspirado en la piedra natural travertino.

A su vez, el resurgimiento del **mosaico tradicional** combinado con la versatilidad del grés porcelánico – en los formatos 14 x 14 cm y 7 x 29 cm – y el estilo urbano y contemporáneo del **efecto metalizado**, ofrecen espacios ecléticos y modernos que reflejan la personalidad de quien los proyecta.

NUEVAS SOLUCIONES TÉCNICAS

La nueva solución **PRO SYSTEM** es un pavimento sostenible e innovador, fácil de aplicar y reutilizable, adecuado para suelos elevados. Una superficie antideslizante con efecto madera y sistema de fijación 100% invisible que conjuga todas las ventajas del grés porcelánico: la durabilidad y la inalterabilidad, la resistencia a las manchas y al desgaste, y una excelente resistencia al impacto.



LIGHT XL



PRO SYSTEM



LIGHT XL

revigrés



REVIGRÉS TECH

DESIGN & INNOVATION

DESIGN & INNOVAÇÃO

A REVIGRÉS aposta no desenvolvimento de projetos criativos e multifuncionais que conjugam funções técnicas e estéticas.

REVIGRÉS TECH

REVISILENT
Pavimento com isolamento acústico. Cerâmica & cortiça.

REWISENSE
Cerâmica sensível: sem botões, sem teclas.

REVICOMFORT
Pavimento em grés porcelânico amovível e reutilizável.

REVICARE
Revestimento e pavimento antibacteriano.

DESIGN & INNOVATION

REVIGRÉS is committed to the development of creative and multifunctional projects which combine aesthetic and technical functions.

REVIGRÉS TECH

REVISILENT
Soundproof floor tile. Ceramics & cork.

REWISENSE
Sensitive ceramics: no buttons, no keys.

REVICOMFORT
Removable and reusable full body porcelain floor tiles.

REVICARE
Antibacterial wall and floor tile.

DESIGN & INNOVATION

REVIGRÉS parie sur le développement de projets créatifs et multifonctionnels, qui conjuguent les fonctions esthétiques et techniques.

REVIGRÉS TECH

REVISILENT
Revêtement de sol avec isolation acoustique. Céramique & liège.

REWISENSE
Céramique sensitive: pas de boutons, pas de touches.

REVICOMFORT
Sol en grès cérame portable et reutilisable.

REVICARE
Muraux et revêtements de sol antibactérien.

DISEÑO & INNOVACIÓN

REVIGRÉS apuesta por la ejecución de proyectos creativos y multifuncionales que combinan funciones estéticas y técnicas.

REVIGRÉS TECH

REVISILENT
Pavimento con aislamiento acústico. Cerámica y corcho.

REWISENSE
Cerámica sensible: sin botones, sin teclas.

REVICOMFORT
Pavimento en gres porcelánico portátil y reutilizable.

REVICARE
Revestimiento y pavimento antibacteriano.



REVISILENT



REWISENSE



REVICOMFORT



REVICARE



EPD'S

OUR TILES ARE GREEN

A NOSSA CERÂMICA É VERDE

Reduzir o impacto ambiental das nossas escolhas, no planeta - e, consequentemente, melhorar a nossa Pegada Ecológica - sem abdicar do conforto e saúde, do design e da qualidade é uma tendência que ganha força todos os dias.

Na Revigrés, assumimos como nossas estas preocupações, integrando-as nos nossos valores institucionais e materializando-as numa Política Ambiental estruturada, apoiada no investimento em inovação e na adoção de um comportamento eco-eficiente.

- A opção pelo ECODSIGN: um plano e processo produtivo mais eficiente que permite uma redução nos impactos ambientais.
- Biblioteca de Objetos BIM (Building Information Modeling), compatível com a transição digital da Construção 4.0, contribuindo para a descarbonização deste setor de atividade.
- A Revigrés é certificada na Gestão Ambiental, o que inclui a sistematização e controlo dos processos, em conformidade com o referencial normativo NP EN ISO 14001:2015.
- Conformidade com Marcação CE.

OUR TILES ARE GREEN

Being able to reduce the environmental impact of our choices on the planet - and subsequently improving our carbon footprint - without giving up the comfort and health, design and quality, is a trend gaining strength every day.

At Revigrés we assume these concerns as our own, incorporating them into our institutional values and transforming them into a structured Environmental Policy, backed by investment in innovation and the adoption of eco-efficient behaviour.

- Choosing ECODSIGN: a more efficient production plan and process that reduces the environmental impact.
- The BIM (Building Information Modeling) object library, compatible with the digital transition of Construction 4.0, is helping to decarbonize the industry.
- Revigrés has Certification in Environmental Management, which includes process systematisation and monitoring, in accordance with the reference standard NP EN ISO 14001:2015.
- Compliance with CE Marking.

NOTRE CÉRAMIQUE EST VERTE

Réduire l'impact environnemental de nos choix sur la planète, et, par conséquent, améliorer notre empreinte écologique sans renoncer au confort et à la santé, au design et à la qualité est une tendance qui s'impose de jour en jour.

Chez Revigrés, nous assumons comme nôtres ces préoccupations, en les intégrant dans nos valeurs institutionnelles et en les matérialisant dans une Politique Environnementale structurée, soutenue par des investissements dans l'innovation et l'adoption de comportements éco-efficaces.

- Le choix de l'ECODSIGN: un plan et un processus de production plus efficace qui permet une réduction de l'impact sur l'environnement.
- Bibliothèque d'objets BIM (Building Information Modelling), compatible avec la transition numérique de la Construction 4.0, contribuant à la décarbonisation de ce secteur d'activité.
- Revigrés est certifiée en Management de l'Environnement, ce qui comprend la systématisation et le contrôle des procédés, conformément au référentiel normatif NP EN ISO 14001: 2015.
- Conformité aux Marquage CE.

NUESTRA CERÁMICA ES VERDE

Reducir el impacto medioambiental de nuestras elecciones en el planeta —y, por tanto, mejorar nuestra huella ecológica—, sin renunciar al confort y a la salud, al diseño y a la calidad, es una tendencia que cobra fuerza cada día.

En Revigrés, asumimos como propias estas preocupaciones, las integramos en nuestros valores institucionales y las materializamos en una política medioambiental estructurada, apoyada en la inversión en innovación y en la adopción de un comportamiento ecoeficiente.

- La elección del ECODSIGN: un plan y un proceso productivo más eficientes que permiten reducir el impacto medioambiental.
- Biblioteca de Objetos BIM (Building Information Modeling), compatible con la transición digital de la Construcción 4.0, contribuyendo a la descarbonización de este sector.
- Revigrés está certificada en gestión medioambiental, que incluye la sistematización y el control de procesos, de conformidad con la norma de referencia NP EN ISO 14001:2015.
- En conformidad con Marcado CE.

DESEMPENHO AMBIENTAL _ ENVIRONMENTAL PERFORMANCE PERFORMANCE ENVIRONNEMENTALE _ RENDIMIENTO AMBIENTAL



A gestão das emissões de CO₂ e implementação de medidas para a sua redução.
Managing CO₂ emissions and implementing reduction measures.
La gestion des émissions de CO₂ et la mise en oeuvre de mesures pour les réduire.
La gestión de las emisiones de CO₂ y la implementación de medidas para su reducción.



A produção de energia elétrica através de painéis fotovoltaicos, que contribuem para 20% do total de energia elétrica consumida.
Power produced by photovoltaic cells, which account for 20% of all electric energy used.
La production d'électricité par des panneaux photovoltaïques, qui contribuent à 20% de l'énergie électrique totale consommée.
La producción de energía eléctrica utilizando paneles fotovoltaicos, que aportan el 20 % de la energía total consumida.



A reutilização da totalidade das águas residuais industriais e otimização do consumo de água.
Reusing all industrial wastewater and optimising water consumption.
La réutilisation de la totalité des eaux usées industrielles et l'optimisation de la consommation d'eau.
La reutilización de todas las aguas residuales industriales y la optimización del consumo de agua.



A valorização de 98% dos resíduos do processo, incorporados diretamente na produção e noutros processos fabris. A utilização de embalagens recicladas na sua totalidade.
Recovering 98% of all waste that results from the process and using it in production and other manufacturing processes. Using fully recycled packaging.
La valorisation de 98% des déchets du process et leur l'incorporation dans la production et d'autres procédés de fabrication. L'utilisation d'emballages recyclés dans leur intégralité.

La recuperación del 98% de los residuos del proceso, incorporados directamente a la producción y a otros procesos fabriles. La utilización de embalajes reciclados en su totalidad.



A implementação de um plano de racionalização energética dos processos e equipamentos.
Implementing an energy efficiency plan for procedures and equipment.
La mise en oeuvre d'un plan de rationalisation énergétique des procédés et des équipements.
La implementación de un plan de racionalización energética de los procesos y equipamientos.



ENVIRONMENTAL PRODUCT DECLARATIONS



PRODUTOS ECOLÓGICOS: certificados com DECLARAÇÕES AMBIENTAIS DE PRODUTO (DAP'S), segundo a Norma ISO 14025 (tipo III), compatíveis com os Sistemas de Certificação da Construção Sustentável BREEAM e LEED, que quantificam o seu impacto ambiental.
GREEN PRODUCTS: certified by ENVIRONMENTAL PRODUCT DECLARATIONS (EPDs), pursuant to standards ISO 14025 (type III), compatible with BREEAM and LEED Sustainable Construction Certification Systems that quantify their environmental impact.
PRODUITS ECOLOGIQUES: certifiées à travers des DÉCLARATIONS ENVIRONNEMENTALES PRODUIT (DEPs), selon la Norme ISO 14025 (type III), compatibles avec les Systèmes de Certification de Construction Durable BREEAM et LEED, qui quantifient leur impact environnemental.
PRODUCTOS ECOLÓGICO: certificados con DECLARACIONES AMBIENTALES DE PRODUCTO (DAPs), según la norma ISO 14025 (tipo III), compatibles con los sistemas de certificación de construcción sostenible BREEAM y LEED, que cuantifican su impacto medioambiental.



ORIGEM NA NATUREZA: matérias-primas inertes e tintas de base aquosa, com consequente redução de resíduos perigosos.
ORIGIN IN NATURE: inert matter and water-based paints and subsequently reducing hazardous waste.
ORIGINE DANS LA NATURE: des matériaux inertes et des teints à base d'eau et, donc, une réduction des déchets dangereux.
ORIGEN NATURAL: materias primas inertes y pinturas a base de agua y la consecuente reducción de residuos peligrosos.



ELEVADA DURABILIDADE: acompanha a longevidade do edifício, o que reduz o impacto ambiental da sua produção, instalação e deposição.
HIGH DURABILITY: matches the longevity of the building, thus reducing the environmental impact of its production, installation and disposal.
HAUTE DURABILITÉ : accompagne la durée de vie du bâtiment, ce qui réduit l'impact environnemental de sa production, de sa pose et de son recyclage.
GRAN DURABILIDAD: acompaña la longevidad del edificio, lo que reduce el impacto medioambiental de su producción, instalación y eliminación.



Resistência às manchas e a químicos.
Resistance to staining and chemicals.
Résistance aux taches et aux substances chimiques.
Resistencia a las manchas y a los productos químicos.



Resistência ao fogo.
Resistance to fire.
Résistance au feu.
Resistencia al fuego.



SEGURANÇA: não emite substâncias tóxicas mesmo quando exposto a elevadas temperaturas.
SAFETY: does not release toxic substances, promoting a healthier and safer indoor environment.
SÉCURITÉ: il n'émet pas de substances toxiques, même lorsqu'il est exposé à des sources de chaleur.
SEGURIDAD: no emite sustancias tóxicas ni cuando está expuesto a fuentes de calor.



É um material higiénico, sem odores e fácil de limpar com produtos de limpeza neutros e pouca água.
Hygienic, odour-free and easy to clean with neutral, chemical-free agents and little water.
C'est un matériau hygiénique, sans odeur et facile à nettoyer avec des produits d'entretien neutres, sans produits chimiques et avec une faible quantité d'eau.

Es un material higiénico, sin olores y fácil de limpiar con productos neutros de limpieza, sin químicos y poca agua.



EFICIÊNCIA ENERGÉTICA: favorece o isolamento térmico, funcionando como um excelente condutor para piso radiante.
ENERGY EFFICIENCY: good heat insulator and excellent conductor for underfloor heating.
EFFICACITÉ ÉNERGÉTIQUE: favorise l'isolation thermique et agit comme un excellent conducteur pour le chauffage par le sol.
EFICIENCIA ENERGÉTICA: favorece el aislamiento térmico y funciona como un excelente conductor para el suelo radiante.



Fácil de demolir e reciclar.
Easy to demolish and recycle.
Facile à démolir et à recycler.
Fácil de demoler y reciclar.



WEBSITE



A PORTUGUESE TOUCH

UM TOQUE PORTUGUÊS

Constituída em 1977, a Revigrés produz revestimentos e pavimentos em grés porcelânico, revestimentos e pavimentos em grés porcelânico esmaltado e revestimentos cerâmicos vidrados, ocupando uma posição de liderança no setor cerâmico.

Mais de 46 anos dedicados ao desenvolvimento de soluções de cerâmica inovadoras e de design exclusivo, que dão vida aos espaços, com o selo de qualidade de uma empresa 100% portuguesa.

O edifício comercial da Revigrés – inaugurado em 1997 – é um projeto do Arquiteto Álvaro Siza Vieira, o primeiro vencedor do Prémio Pritzker, em Portugal.

UNE TOUCHE PORTUGAISE

Founded in 1977, Revigrés produces full body porcelain wall and floor tiles, glazed porcelain wall and floor tiles and glazed ceramic wall tiles, occupying a leading position in the ceramics industry.

It has dedicated more than 46 years to developing innovative ceramic solutions with a unique design, which bring spaces to life, with the quality seal of a 100% Portuguese owned company.

The commercial building of Revigrés – opened in 1997 – was designed by Architect Álvaro Siza Vieira, the first architect to have received the Pritzker Prize in Portugal.

A PORTUGUESE TOUCH

Fondée en 1977, Revigrés produit de la faïence en pâte blanche, du grés cérame émaillé et du grés cérame pleine masse, occupant une position de leader dans la filière de la céramique.

Plus de 46 années consacrées au développement de solutions en céramique innovantes et au design exclusif qui confèrent de la vivacité aux espaces, avec le label de qualité d'une société 100% portugaise.

Le bâtiment commercial Revigrés – inauguré en 1997 – est un projet de l'architecte Álvaro Siza Vieira, premier lauréat du prix Pritzker au Portugal.

UN TOQUE PORTUGUÊS

Creada en 1977, Revigrés produce revestimientos y pavimentos de gres porcelánico, revestimientos esmaltado, y revestimientos cerámicos vidriados, ocupando una posición de liderazgo en el sector cerámico.

Más de 46 años dedicados al desarrollo de soluciones de cerámica innovadoras y con un diseño exclusivo, que dan vida a los espacios, con el sello de calidad de una empresa 100 % portuguesa.

El edificio comercial de Revigrés – inaugurado en 1997 – es un proyecto del arquitecto Álvaro Siza Vieira, el primer ganador del Premio Pritzker portugués.



Álvaro Siza Vieira
arquiteto_architect

A Revigrés dispõe de showrooms na sede (Barrô, Águeda) e em Lisboa, com uma equipa atenta e um atendimento especializado.

Revigrés has a showroom at the head-office (Barrô - Águeda) and in Lisbon, managed by a dedicated team offering an expert service.

Revigrés dispose de showrooms dans son siège (Barrô - Águeda) et à Lisbonne, avec une équipe dévouée et un service spécialisé.

Revigrés cuenta con salas de exposición en su sede (Barrô - Águeda) y en Lisboa, en las que un equipo atento ofrece una atención especializada.



Showroom de Águeda
Águeda showroom _ Showroom Águeda _ Sala de exposición de Águeda



Showroom de Lisboa
Lisbon showroom _ Showroom à Lisbonne _ Sala de exposición de Lisboa



WEBSITE

GLOBAL QUALITY

QUALIDADE GLOBAL

A Revigrés tem a quádrupla certificação dos seus sistemas de gestão integrados, nos seguintes referenciais: Qualidade; Ambiente; Responsabilidade Social; Investigação, Desenvolvimento e Inovação.

Design e Inovação são as linhas que nos orientam em todos os projetos que desenvolvemos. Esta aposta tem merecido o reconhecimento do mercado nacional e internacional com a atribuição de várias distinções.

O vestido "Caravela de Azulejos" da dupla de estilistas Storytailors - uma verdadeira obra de arte que exhibe peças da Coleção Cromática - já foi a estrela de exposições e eventos de moda internacionais.

Quem não conhece o patrocínio da Revigrés ao FC Porto? Com 41 anos consecutivos, este foi o 1º patrocínio de uma empresa portuguesa a um clube de futebol e é já o mais duradouro a nível mundial.

GLOBAL QUALITY

Revigrés has a four-time certification of its integrated management systems, in the following references: Quality; Environment; Social Accountability; Research, Development and Innovation.

We are guided by Design and Innovation in all projects we develop. This focus has earned Revigrés national and international recognition, having been awarded many prizes.

The dress "Tile Caravel" by fashion designers Storytailors, a true work of art with pieces of our Cromática Collection, was the star at a series of international exhibitions and fashion events.

Who doesn't know that Revigrés sponsors FC Porto football club? Going on for 41 consecutive years, this was the 1st time a Portuguese company sponsored a football club and this is already the longest lasting sponsorship in the world.

QUALITÉ GLOBALE

Revigrés a la quadruple certification de ses systèmes de gestion intégrée, pour les référentiels suivants: Qualité; Environnement; Responsabilité Sociale; Recherche, Développement et Innovation.

Design et Innovation sont les lignes qui nous guident dans tous les projets que nous développons. Ce pari a mérité la reconnaissance du marché national et international avec l'attribution de plusieurs distinctions.

La robe « Caravelle d'azulejos » dont les auteurs sont les deux grands couturiers Storytailors – une véritable œuvre d'art qui arbore des pièces de la collection Cromática – a été attraction principale lors d'expositions et d'événements de mode internationaux.

Qui ne connaît pas le sponsoring de Revigrés au FC Porto? 41 ans d'affilée, ce fut le premier parrainage d'une société portugaise à un club de football et c'est déjà le plus long au monde.

CALIDAD GLOBAL

Revigrés posee el quádruple certificado de sus sistemas de gestión integrados en los siguientes ámbitos: calidad, medioambiente, Responsabilidad Social, Investigación y Desarrollo e Innovación.

Diseño e Innovación son las directrices que nos guían en todos los proyectos que llevamos a cabo. Esta apuesta ha merecido el reconocimiento del mercado portugués e internacional a través de la concesión de varias distinciones.

El vestido "Caravela de Azulejos" del dúo de estilistas Storytailors —una verdadera obra de arte que incluye piezas de la colección Cromática— ya se ha convertido en la estrella de exposiciones y eventos de moda internacionales.

¿Y quién no conoce el patrocínio de Revigrés al FC Porto? El primer patrocínio de una empresa portuguesa a un equipo de fútbol cumple ya 41 años consecutivos, lo que lo convierte en el más duradero del mundo.



Vestido "Caravela de Azulejos" "Tile Caravel" dress



Painel dos Fundadores — Mestre Júlio Resende, Estádio do Dragão (FC Porto) Founders' Panel — Painter Júlio Resende, Dragon Stadium (FC Porto)



NP 4457
NP 4469-1



ISO 9001
ISO 14001



reddot design award winner 2015



PORTFOLIO
PORTFÓLIO
PORTFOLIO
CARTERA



TESTEMUNHOS
TESTIMONIES
TÉMOIGNAGES
TESTIMONIOS

A PARTNER FOR YOUR PROJECT

UM PARCEIRO PARA O SEU PROJETO

Presente em mais de 50 países, a Revigrés mantém uma relação de estreita parceria e colaboração com os profissionais no mercado nacional e internacional, sendo frequentemente selecionada para se associar a obras de grande impacto.

A flexibilidade para oferecer soluções de design exclusivo e personalizadas, adaptadas às especificidades de cada projeto e às necessidades dos seus parceiros, é o foco principal da sua atividade e um dos seus pilares estratégicos.

A Revigrés tem vindo a desenvolver variadíssimas cores da Coleção Cromática, em exclusivo, para peças aplicadas no medalhão central, no interior, e nos pináculos exteriores da Basílica La Sagrada Família, em Barcelona. Já foram aplicadas 28 das mais de 50 cores desenvolvidas para o projeto.

Em Portugal, entre outras obras, a Revigrés desenvolveu produtos especiais de acordo com os vários projetos apresentados, para diversos estádios do EURO 2004.

A PARTNER FOR YOUR PROJECT

Present in more than 50 countries, Revigrés collaborates closely and in partnership with professionals in the domestic and international markets, and is often chosen to participate in major works.

The flexibility to offer exclusive and customised design solutions, adapted to the specificities of each project and partners' needs, is the main focus of its activity and one of its strategic pillars.

Revigrés has been developing new and exclusive colours from the Chromatic Collection used on the tiles of the central medallion inside the basilica, and the external pinnacles of La Sagrada Família, in Barcelona. 28 of the more than 50 colours developed for the project were already applied.

In Portugal, among other works, Revigrés developed special products for several of the EURO 2004 football stadiums.

UN PARTENAIRE POUR VOTRE PROJET

Présente dans plus de 50 pays, Revigrés entretient une relation étroite de partenariat et de collaboration avec les professionnels du marché national et international, étant souvent choisie pour s'associer à des ouvrages à fort impact.

La flexibilité d'offrir des solutions de design exclusif et personnalisées, adaptées aux spécificités de chaque projet et aux besoins de ses partenaires, est le but principal de l'activité de Revigrés et l'un de ses piliers stratégiques.

Revigrés a mis au point, en exclusivité, une grande palette de couleurs de la Collection Chromatique, pour des pièces appliquées sur le médaillon central, à l'intérieur, et dans les pinacles extérieurs de la Sagrada Família à Barcelone. 28 parmi plus de 50 couleurs créées pour le projet ont déjà été appliquées.

Au Portugal, entre autres projets, Revigrés a mis au point des produits spéciaux en fonction de différents projets présentés, pour plusieurs stades à l'occasion du championnat de foot : l'EURO 2004.

UN SOCIO PARA SU PROYECTO

Presente en más de 50 países, Revigrés mantiene una estrecha relación de asociación y colaboración con los profesionales del mercado portugués e internacional, y resulta frecuentemente seleccionada para participar en obras de gran impacto.

La flexibilidad para ofrecer soluciones de diseño exclusivas y personalizadas, adaptadas a las particularidades de cada proyecto y a las necesidades de sus socios, es el eje principal de la actividad de Revigrés y uno de sus pilares estratégicos.

Revigrés ha desarrollado, en exclusiva, colores muy variados de la colección Cromática para piezas aplicadas en el medallón central, en el interior y en los pináculos exteriores de la basílica de la Sagrada Família, en Barcelona. Ya se han aplicado 28 de los más de 50 colores desarrollados para el proyecto.

En Portugal, entre otros proyectos, Revigrés ha desarrollado productos especiales de conformidad con los distintos proyectos presentados para diversos estadios de la EURO 2004.

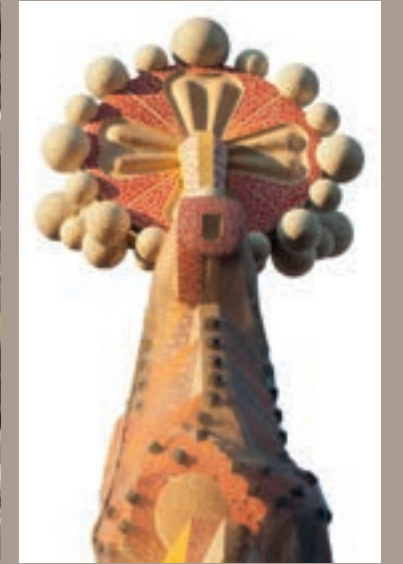
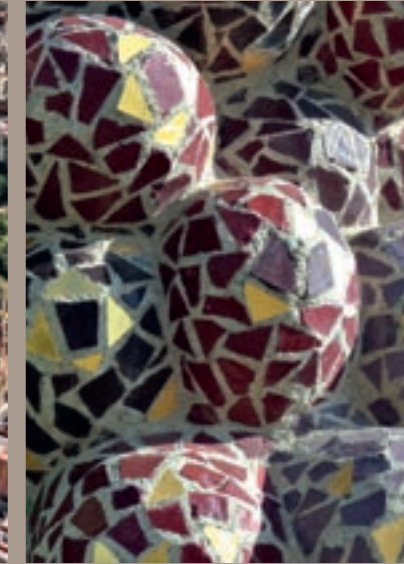

Basilica La Sagrada Família — Barcelona, Espanha
Basilica La Sagrada Família — Barcelona, Spain



Painel Caras — Estádio do Dragão (FC Porto)
Faces' Panel — Dragon Stadium (FC Porto)

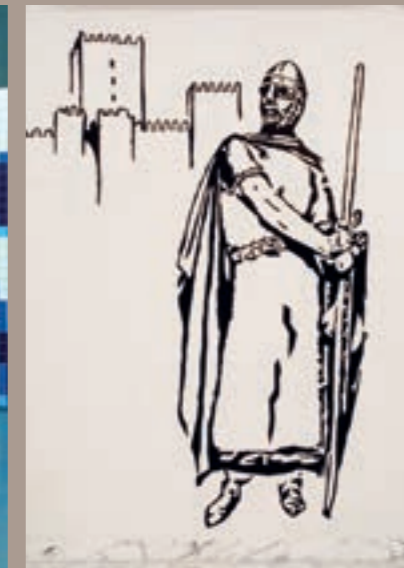

Estádio D. Afonso Henriques (Vitória Sport Clube de Guimarães) — Arq. Eduardo Guimarães
D. Afonso Henriques Stadium (Vitória Sport Clube de Guimarães) — Eduardo Guimarães, architect



Estádio Alvalade XXI (Sporting Clube de Portugal) — Arq. Tomás Taveira
Alvalade XXI Stadium (Sporting Club of Lisbon) — Tomás Taveira, architect

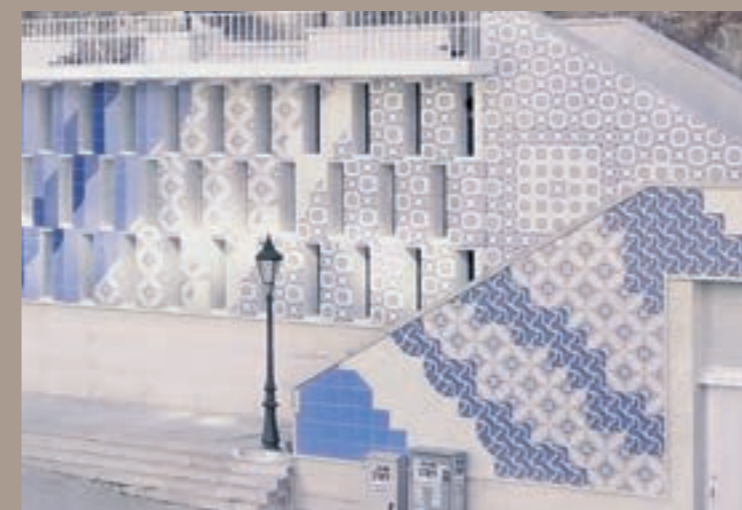

Mural de Azulejos "Louvor da Vivacidade" - Designer Add Fuel (Diogo Machado) — Lisboa, Portugal
"Louvor da Vivacidade" Tiles Mural - Designer Add Fuel (Diogo Machado) — Lisbon, Portugal



Mural de Azulejos "Da Água ao Jardim" - Arq. Ania Gabriel Abrantes — Aveiro, Portugal
"Da Água ao Jardim" Tiles Mural - Ania Gabriel Abrantes, architect — Aveiro, Portugal



FULL-BODY

TODA A MASSA · PLEINE MASSE · TODO MASA

Cromática	024
Omni	052
Omnistone	062
Flint	070
Pigmento	078



CROMÁTICA BONE _ CROMÁTICA PALM _ CROMÁTICA BRICK _ TRIO AUTUMN

FULL-BODY

CROMÁTICA

30 cores / colours / colores 10 formatos / formats / formatos 3 acabamentos / finishes / acabados



Uma coleção com elevada qualidade técnica que permite criar novos padrões para ambientes personalizados.

A high technical quality collection that allows you to design new patterns for customised environments.

Une collection avec une grande qualité technique qui permet de créer de nouveaux motifs pour des ambiances personnalisées.

Una colección con gran calidad técnica que permite crear nuevos estándares para ambientes personalizados.

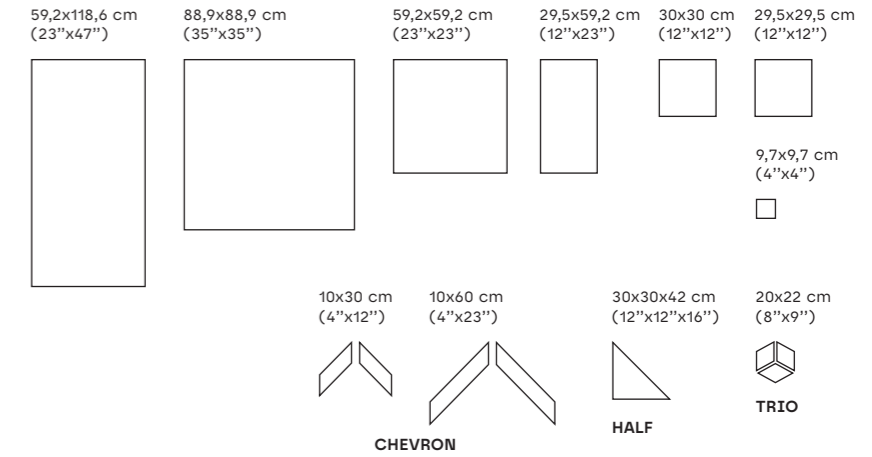

MATT NAT · MATT RECT · SOFT · POL

Ice	Platina	Bone	Toffee	Anis	Oliva
Superbranco	Arg Prata	Quartz	Ocre	Jade	Palm
Alloy	Antracite	Lava	Coral	Lagoon	Opala
Titanium	Preto	Astral	Brick	Teal	Cobalto
Grafite	Jet	Bege	Terracotta	Pistachio	Indigo

CROMÁTICA

CROMÁTICA

FULL BODY

	9,7x9,7 cm (*)			29,5x29,5 cm (**)				29,5x59,2 cm (**)			59,2x59,2 cm				88,9x88,9 cm (***)			59,2x118,6 cm			Half (*)	Chevron (*)	Trio
	SOFT	MATT NAT	MATT RECT	SOFT	POL	MATT RECT	SOFT	POL	14mm MATT RECT	MATT RECT	SOFT	POL	MATT RECT	SOFT	POL	MATT RECT	SOFT	POL	29,5x29,5x41,7 SOFT	9,7x29,5 9,7x59,2 SOFT	20x22 SOFT		
ICE	■			■	■	■	■	■	■	■	■	■	■	■	■	■	■	■		▲			
SUPERBRANCO	■	■	■	■	■	■	■	■	■	■	■	■	■	■	■	■	■	■	■	▲	▲	CHILL OUT	
ALLOY	■		■	■	■	■	■	■	■	■	■	■	■	■	■	■	■	■	■	▲		WINTER	
TITANIUM	■		■	■	■	■	■	■	■	■	■	■	■	■	■	■	■	■	■	▲		WINTER	
GRAFITE	■	■	■	■	■	■	■	■	■	■	■	■	■	■	■	■	■	■	■	▲	▲	WINTER	
PLATINA	■		■	■	■	■	■	■	■	■	■	■	■	■	■	■	■	■	■	▲	▲	SUMMER NIGHT	
ARG PRATA	■								■	■	■	■	■	■	■	■	■	■	■	▲			
ANTRACITE	■			■	■			■	■	■	■	■	■	■	■	■	■	■	■	▲	▲		
PRETO	■	■		■	■	■	■	■	■	■	■	■	■	■	■	■	■	■	■	▲	▲		
JET	■			■	■	■	■	■	■	■	■	■	■	■	■	■	■	■	■	▲	▲		
BONE	■	■	■	■	■	■	■	■	■	■	■	■	■	■	■	■	■	■	■	▲	▲	SPRING SUN FRESHY AUTUMN SAFARI	
QUARTZ	■		■	■	■	■	■	■	■	■	■	■	■	■	■	■	■	■	■	▲	▲	BLOOM	
LAVA	■								■	■	■	■	■	■	■	■	■	■	■	▲			
ASTRAL	■							■	■	■	■	■	■	■	■	■	■	■	■	▲	▲	CHILL OUT SAFARI	
BEGE	■	■	■	■	■	■	■	■	■	■	■	■	■	■	■	■	■	■	■	▲	▲	CHILL OUT	
TOFFEE	■		■	■	■	■	■	■	■	■	■	■	■	■	■	■	■	■	■	▲	▲	SAFARI	
OCRE	■	■	■	■	■	■	■	■	■	■	■	■	■	■	■	■	■	■	■	▲	▲	SPRING SUN	
CORAL	■								■	■	■	■	■	■	■	■	■	■	■	▲	▲	BLOOM	
BRICK	■								■	■	■	■	■	■	■	■	■	■	■	▲	▲	AUTUMN	
TERRACOTTA	■								■	■	■	■	■	■	■	■	■	■	■	▲	▲	BLOOM	
ANIS	■	■	■	■	■	■	■	■	■	■	■	■	■	■	■	■	■	■	■	▲	▲		
JADE	■								■	■	■	■	■	■	■	■	■	■	■	▲	▲		
LAGOON	■		■	■	■	■	■	■	■	■	■	■	■	■	■	■	■	■	■	▲	▲	FRESHY	
TEAL	■								■	■	■	■	■	■	■	■	■	■	■	▲	▲		
PISTACHIO	■								■	■	■	■	■	■	■	■	■	■	■	▲	▲	FRESHY	
OLIVA	■	■	■	■	■	■	■	■	■	■	■	■	■	■	■	■	■	■	■	▲	▲	SPRING SUN	
PALM	■								■	■	■	■	■	■	■	■	■	■	■	▲	▲	AUTUMN	
OPALA	■								■	■	■	■	■	■	■	■	■	■	■	▲	▲	SUMMER NIGHT	
COBALTO	■								■	■	■	■	■	■	■	■	■	■	■	▲	▲		
INDIGO	■								■	■	■	■	■	■	■	■	■	■	■	▲	▲	SUMMER NIGHT	

Trio

■ Chill Out
■ Winter
■ Summer Night
■ Bloom
■ Spring Sun
■ Freshy
■ Autumn
■ Safari



FULL BODY

(*) Peças produzidas de acordo com quantidades mínimas de 5m².
 (*) Pieces produced in minimum quantities of 5m².
 (*) Pièces produites selon des quantités minimales de 5m².
 (*) Piezas producidas en cantidades mínimas de 5m².

(**) Consultar tabela Cromática Level.
 (**) See the Cromatica Level table.
 (**) Consultez le tableau Cromatica Level.
 (**) Consulta la tabla Cromática Level.

(***) Cromática ice: 87,0x87,0 cm
 (***) Cromática ice: 87,0x87,0 cm
 (***) Cromática ice: 87,0x87,0 cm
 (***) Cromática ice: 87,0x87,0 cm



TRIO CROMÁTICA

CENTRO COMERCIAL NORTE SHOPPING — PORTO, PORTUGAL
NORTE SHOPPING CENTER — OPORTO, PORTUGAL



HOTEIS DO GRUPO VILA GALÉ — PORTUGAL
VILA GALÉ GROUP HOTELS — PORTUGAL

CROMÁTICA QUARTZ _ CROMÁTICA GRAFITE



CASINO DE VALÊNCIA — ESPANHA
VALENCIA CASINO — SPAIN

CROMÁTICA PRETO _ CROMÁTICA SUPERBRANCO

CROMÁTICA

FULL BODY

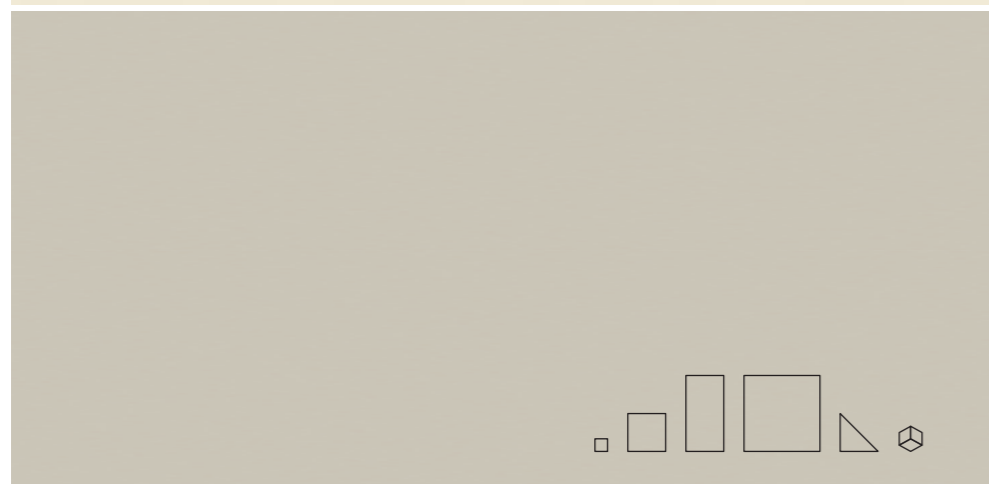
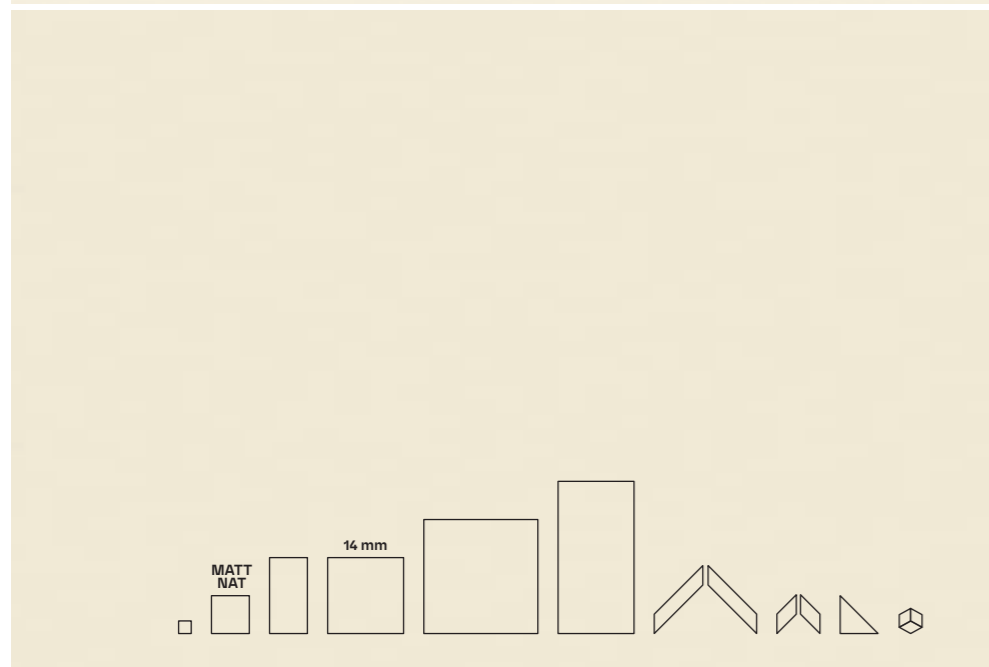
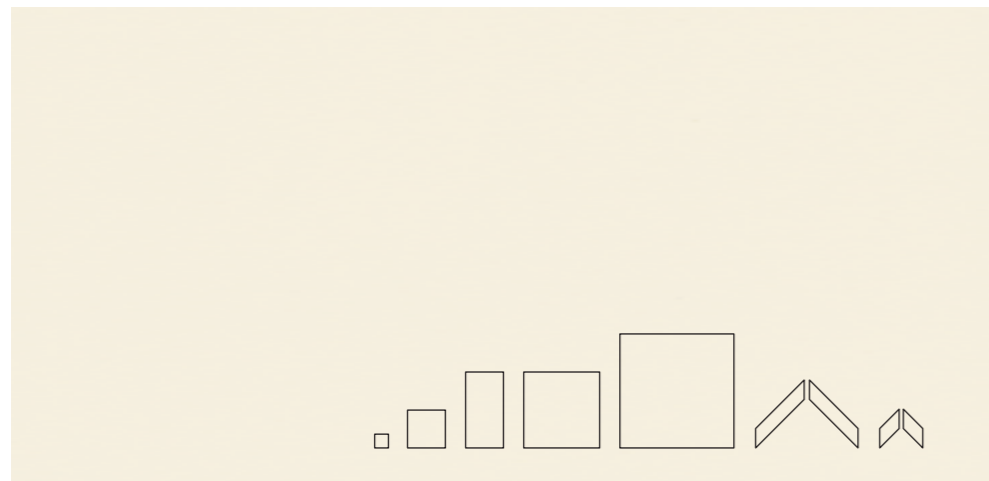

CROMÁTICA ICE

3126081201	(*)9,7x9,7x0,90 cm	SOFT	P191
312B121191	29,5x29,5x0,90 cm	MATT RECT	P171
3126121201	29,5x29,5x0,90 cm	SOFT	P171
3711121191	29,5x29,5x0,85 cm	POL	P185
312B211201	29,5x59,2x0,90 cm	MATT RECT	P171
3126211201	29,5x59,2x0,90 cm	SOFT	P171
3122211191	29,5x59,2x0,85 cm	POL	P185
312B131201	59,2x59,2x0,90 cm	MATT RECT	P171
3126131201	59,2x59,2x0,90 cm	SOFT	P171
3711131201	59,2x59,2x0,85 cm	POL	P185
312BK71191	87,0x87,0x1,05 cm	MATT RECT	P199
3126K71201	87,0x87,0x1,05 cm	SOFT	P199
3122K71201	87,0x87,0x0,98 cm	POL	P219

CROMÁTICA SUPERBRANCO

3126080071	(*)9,7x9,7x0,85 cm	SOFT	P143
312A120071	30x30x0,77 cm	MATT NAT	P92
312B120071	29,5x29,5x0,85 cm	MATT RECT	P123
3126120071	29,5x29,5x0,85 cm	SOFT	P123
3711125071	29,5x29,5x0,80 cm	POL	P137
312B210071	29,5x59,2x0,85 cm	MATT RECT	P123
3126210071	29,5x59,2x0,85 cm	SOFT	P123
3711215071	29,5x59,2x0,80 cm	POL	P137
312B130071	59,2x59,2x0,85 cm	MATT RECT	P123
3126130071	59,2x59,2x0,85 cm	SOFT	P123
3711135071	59,2x59,2x0,80 cm	POL	P137
312BK70071	88,9x88,9x1,05 cm	MATT RECT	P140
3126K70071	88,9x88,9x1,05 cm	SOFT	P140
3122K70071	88,9x88,9x0,98 cm	POL	P158
312BD30071	59,2x118,6x0,98 cm	MATT RECT	P140
3126D30071	59,2x118,6x0,98 cm	SOFT	P140
3122D35071	59,2x118,6x0,93 cm	POL	P158
312B1390T1	59,2x59,2x1,40 cm	MATT RECT	P147

CROMÁTICA ALLOY

3126087S31	(*)9,7x9,7x0,85 cm	SOFT	P143
312B127S31	29,5x29,5x0,85 cm	MATT RECT	P123
3126127S31	29,5x29,5x0,85 cm	SOFT	P123
3122127S31	29,5x29,5x0,80 cm	POL	P137
312B217S31	29,5x59,2x0,85 cm	MATT RECT	P123
3126217S31	29,5x59,2x0,85 cm	SOFT	P123
3122217S31	29,5x59,2x0,80 cm	POL	P137
312B137S31	59,2x59,2x0,85 cm	MATT RECT	P123
3126137S31	59,2x59,2x0,85 cm	SOFT	P123
3122137S31	59,2x59,2x0,80 cm	POL	P137

CROMÁTICA

FULL BODY

CROMÁTICA TITANIUM

3126088S21	(*)9,7x9,7x0,85 cm	SOFT	P119
312B128S21	29,5x29,5x0,85 cm	MATT RECT	P98
3126128S21	29,5x29,5x0,85 cm	SOFT	P98
3122128S21	29,5x29,5x0,80 cm	POL	P114
312B218S21	29,5x59,2x0,85 cm	MATT RECT	P98
3126218S21	29,5x59,2x0,85 cm	SOFT	P98
3122218S21	29,5x59,2x0,80 cm	POL	P114
312B138S21	59,2x59,2x0,85 cm	MATT RECT	P98
3126138S21	59,2x59,2x0,85 cm	SOFT	P98
3122138S21	59,2x59,2x0,80 cm	POL	P114

CROMÁTICA GRAFITE

3126080091	(*)9,7x9,7x0,85 cm	SOFT	P119
312A120091	30,0x30,0x0,77 cm	MATT NAT	P68
312B120091	29,5x29,5x0,85 cm	MATT RECT	P98
3126120091	29,5x29,5x0,85 cm	SOFT	P98
3711120091	29,5x29,5x0,80 cm	POL	P114
312B210091	29,5x59,2x0,85 cm	MATT RECT	P98
3126210091	29,5x59,2x0,85 cm	SOFT	P98
3711210091	29,5x59,2x0,80 cm	POL	P114
312B130091	59,2x59,2x0,85 cm	MATT RECT	P98
3126130091	59,2x59,2x0,85 cm	SOFT	P98
3122130091	59,2x59,2x0,80 cm	POL	P114

312B1389T1	59,2x59,2x1,40 cm	MATT RECT	P123
------------	-------------------	-----------	------

CROMÁTICA PLATINA

3126080081	(*)9,7x9,7x0,85 cm	SOFT	P119
312B120081	29,5x29,5x0,85 cm	MATT RECT	P98
3126120081	29,5x29,5x0,85 cm	SOFT	P98
3711120081	29,5x29,5x0,80 cm	POL	P114
312B214Z81	29,5x59,2x0,85 cm	MATT RECT	P98
3126210081	29,5x59,2x0,85 cm	SOFT	P98
3122210081	29,5x59,2x0,80 cm	POL	P114
312B130081	59,2x59,2x0,85 cm	MATT RECT	P98
3126130081	59,2x59,2x0,85 cm	SOFT	P98
3122130081	59,2x59,2x0,80 cm	POL	P114

CROMÁTICA ARG PRATA

3126080031	(*)9,7x9,7x0,85 cm	SOFT	P119
312B130031	59,2x59,2x0,85 cm	MATT RECT	P98
3126130031	59,2x59,2x0,85 cm	SOFT	P98
3122130031	59,2x59,2x0,80 cm	POL	P114

312B1386T1	59,2x59,2x1,40 cm	MATT RECT	P123
------------	-------------------	-----------	------

29,5x29,5
29,5x59,2

Consultar tabela Cromática Level.
See the Cromatica Level table.
Consultez le tableau Cromatica Level.
Consulta la tabla Cromática Level.



(*) Peças produzidas de acordo com quantidades mínimas de 5m².
(*) Pieces produced in minimum quantities of 5m².
(*) Pièces produites selon des quantités minimales de 5m².
(*) Piezas producidas en cantidades mínimas de 5m².

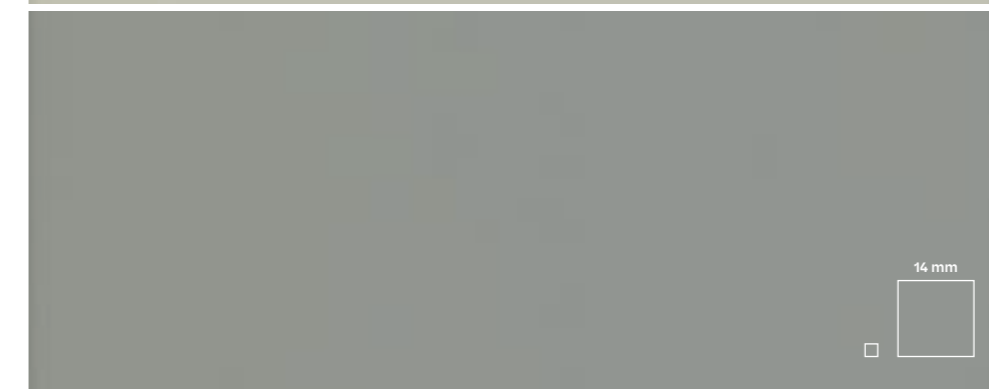
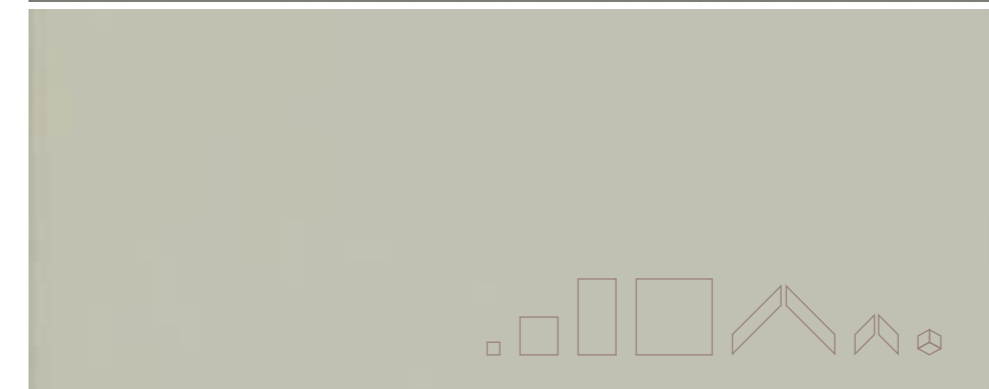
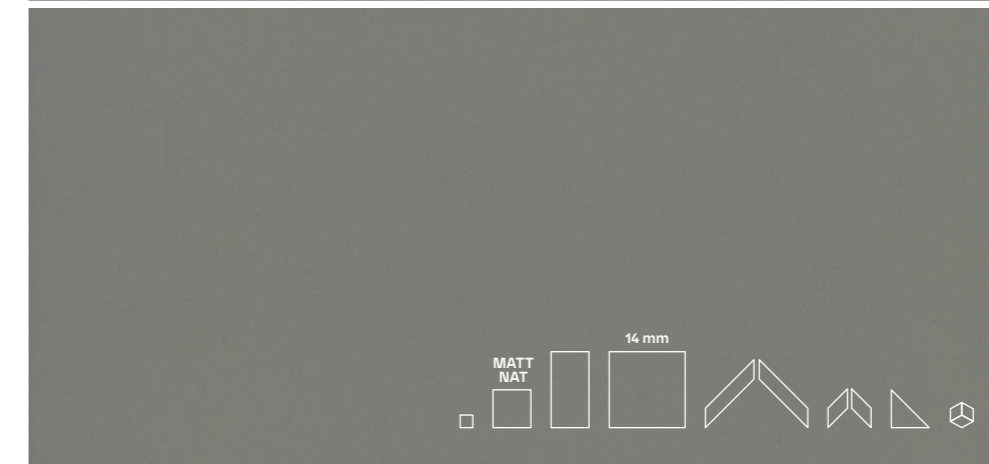
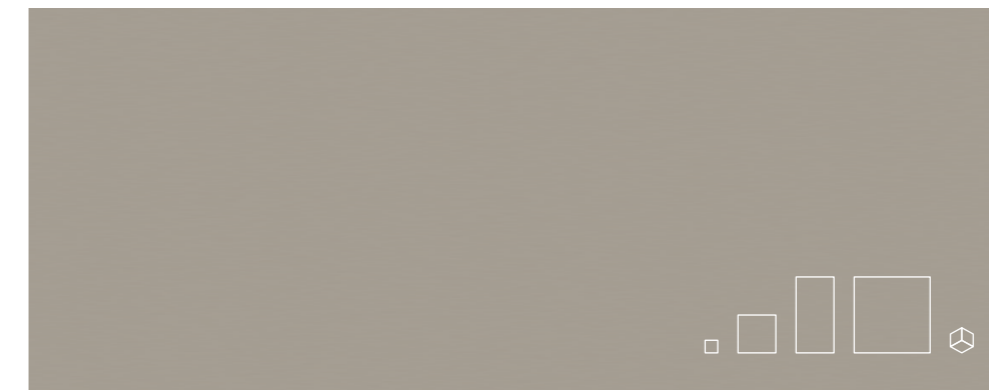

(**) Exceto formato 9,7x9,7 cm.
(**) Except 9,7x9,7 cm format.
(**) Saute format 9,7x9,7 cm.
(**) Excepto formato 9,7x9,7 cm.

30x30 cm	MATT NAT	V1	5	class 2	A	R10	36+	≥0,42	—
29,5x29,5 · 59,2x59,2 cm	MATT RECT	V1	5	class 2	A	R10	36+	≥0,42	U4P4E3C2
9,7x9,7 · 29,5x29,5 · 59,2x59,2 cm	SOFT	V1	5	—	—	—	—	—	U4P4E3C2
29,5x29,5 · 29,5x59,2 · 59,2x59,2 · 59,2x118,6 · 88,9x88,9 cm	POL	V1	3	—	—	—	—	—	U3P3E3C2
29,5x59,2 · 88,9x88,9 · 59,2x118,6 cm	MATT RECT	V1	5	class 2	A	R10	36+	≥0,42	U4P3E3C2
29,5x59,2 · 88,9x88,9 · 59,2x118,6 cm	SOFT	V1	5	—	—	—	—	—	U4P3E3C2
59,2x59,2 cm 14mm	MATT RECT	V1	5	class 1	—	R9	—	≥0,42	U4P4SE3C2

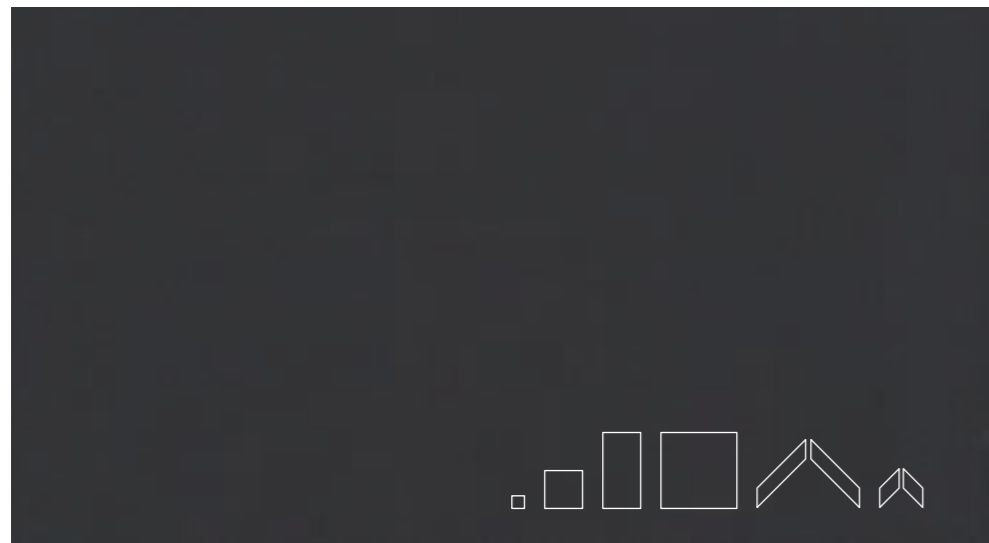

CROMÁTICA ANTRACITE

3126080511	(*)9,7x9,7x0,85 cm	SOFT	P119
3126120511	29,5x29,5x0,85 cm	SOFT	P98
3711120511	29,5x29,5x0,80 cm	POL	P114
3126210511	29,5x59,2x0,85 cm	SOFT	P98
3711210511	29,5x59,2x0,80 cm	POL	P114
3126130511	59,2x59,2x0,85 cm	SOFT	P98
3711130511	59,2x59,2x0,80 cm	POL	P114



CROMÁTICA PRETO

3126080061	(*)9,7x9,7x0,85 cm	SOFT	P119
3511120061	30,0x30,0x0,77 cm	NAT	P68
3126120061	29,5x29,5x0,85 cm	SOFT	P98
3711120061	29,5x29,5x0,80 cm	POL	P114
3126210061	29,5x59,2x0,85 cm	SOFT	P98
3711210061	29,5x59,2x0,80 cm	POL	P114
3126130061	59,2x59,2x0,85 cm	SOFT	P98
3711130061	59,2x59,2x0,80 cm	POL	P114
3126K70061	88,9x88,9x1,05 cm	SOFT	P116
3122K70061	88,9x88,9x0,98 cm	POL	P134
3126D30061	59,2x118,6x0,98 cm	SOFT	P116
3122D30061	59,2x118,6x0,93 cm	POL	P134

14 mm

312B130X91	59,2x59,2x1,40 cm	MATT RECT	P123
------------	-------------------	-----------	------

CROMÁTICA JET

3126081401	(*)9,7x9,7x0,85 cm	SOFT	P143
3126121401	29,5x29,5x0,85 cm	SOFT	P123
3711121401	29,5x29,5x0,80 cm	POL	P137
3126214Z01	29,5x59,2x0,85 cm	SOFT	P123
3122211401	29,5x59,2x0,80 cm	POL	P137
3126131401	59,2x59,2x0,85 cm	SOFT	P123
3711131401	59,2x59,2x0,80 cm	POL	P137
3126K71401	88,9x88,9x1,05 cm	SOFT	P140
3122K71401	88,9x88,9x0,98 cm	POL	P158



CROMÁTICA BONE

312608S741	(*)9,7x9,7x0,85 cm	SOFT	P119
312A12S741	30,0x30,0x0,77 cm	MATT NAT	P68
312B12S741	29,5x29,5x0,85 cm	MATT RECT	P98
312612S741	29,5x29,5x0,85 cm	SOFT	P98
312212S741	29,5x29,5x0,80 cm	POL	P114
312B21S741	29,5x59,2x0,85 cm	MATT RECT	P98
312621S741	29,5x59,2x0,85 cm	SOFT	P98
312221S741	29,5x59,2x0,80 cm	POL	P114
312B13S741	59,2x59,2x0,85 cm	MATT RECT	P98
312613S741	59,2x59,2x0,85 cm	SOFT	P98
312213S741	59,2x59,2x0,80 cm	POL	P114

14 mm

312B1347V1	59,2x59,2x1,40 cm	MATT RECT	P123
------------	-------------------	-----------	------



CROMÁTICA QUARTZ

3126082S61	(*)9,7x9,7x0,85 cm	SOFT	P119
312B122S61	29,5x29,5x0,85 cm	MATT RECT	P98
3126122S61	29,5x29,5x0,85 cm	SOFT	P98
3122122S61	29,5x29,5x0,80 cm	POL	P114
312B212S61	29,5x59,2x0,85 cm	MATT RECT	P98
3126212S61	29,5x59,2x0,85 cm	SOFT	P98
3122212S61	29,5x59,2x0,80 cm	POL	P114
312B132S61	59,2x59,2x0,85 cm	MATT RECT	P98
3126132S61	59,2x59,2x0,85 cm	SOFT	P98
3122132S61	59,2x59,2x0,80 cm	POL	P114

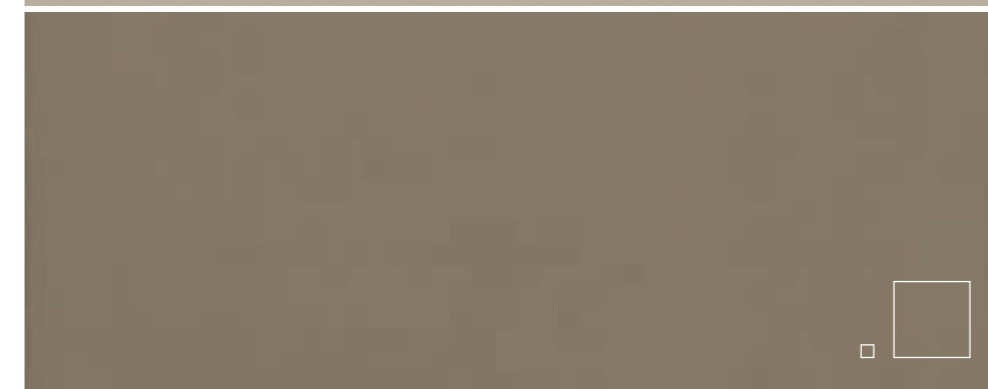

CROMÁTICA LAVA

3126087251	(*)9,7x9,7x0,85 cm	SOFT	P119
312B132Z51	59,2x59,2x0,85 cm	MATT RECT	P98
3126137251	59,2x59,2x0,85 cm	SOFT	P98
3122137251	59,2x59,2x0,80 cm	POL	P114

29,5x29,5
29,5x59,2

Consultar tabela Cromática Level.
See the Cromatica Level table.
Consultez le tableau Cromatica Level.
Consulta la tabla Cromática Level.

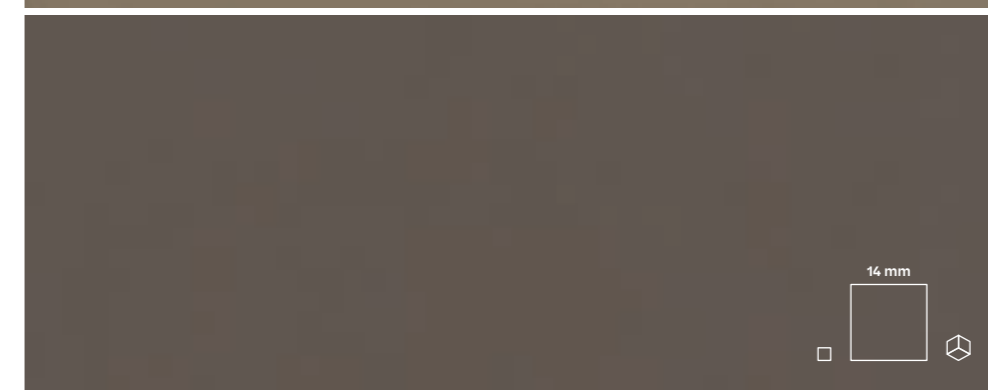

CROMÁTICA ASTRAL

3126087231	(*)9,7x9,7x0,85 cm	SOFT	P119
3126132Z31	59,2x59,2x0,85 cm	SOFT	P98
3122137231	59,2x59,2x0,80 cm	POL	P114

14 mm

312B1387T1	59,2x59,2x1,40 cm	MATT RECT	P123
------------	-------------------	-----------	------

29,5x29,5
29,5x59,2

Consultar tabela Cromática Level.
See the Cromatica Level table.
Consultez le tableau Cromatica Level.
Consulta la tabla Cromática Level.



30x30 cm	MATT NAT	V1	5	class 2	A	R10	36+	≥0,42	—
29,5x29,5 · 59,2x59,2 cm	MATT RECT	V1	5	class 2	A	R10	36+	≥0,42	U4P4E3C2
9,7x9,7 · 29,5x29,5 · 59,2x59,2 cm	SOFT	V1	5	—	—	—	—	—	U4P4E3C2
29,5x29,5 · 29,5x59,2 · 59,2x59,2 · 59,2x118,6 · 88,9x88,9 cm	POL	V1	3	—	—	—	—	—	U3P3E3C2
29,5x59,2 · 88,9x88,9 · 59,2x118,6 cm	MATT RECT	V1	5	class 2	A	R10	36+	≥0,42	U4P3E3C2
29,5x59,2 · 88,9x88,9 · 59,2x118,6 cm	SOFT	V1	5	—	—	—	—	—	U4P3E3C2
59,2x59,2 cm 14mm	MATT RECT	V1	5	class 1	—	R9	—	≥0,42	U4P4SE3C2

(*) Peças produzidas de acordo com quantidades mínimas de 5m².
(*) Pieces produced in minimum quantities of 5m².
(*) Pièces produites selon des quantités minimales de 5m².
(*) Piezas producidas en cantidades mínimas de 5m².

(**) Exceto formato 9,7x9,7 cm.
(**) Except 9,7x9,7 cm format.
(**) Saute format 9,7x9,7 cm.
(**) Excepto formato 9,7x9,7 cm.



CROMÁTICA BEGE

3126080141	(*)9,7x9,7x0,85 cm	SOFT	P119
312A120141	30,0x30,0x0,77 cm	MATT NAT	P68
312B120141	29,5x29,5x0,85 cm	MATT RECT	P98
3126120141	29,5x29,5x0,85 cm	SOFT	P98
3711120141	29,5x29,5x0,80 cm	POL	P114
312B210141	29,5x59,2x0,85 cm	MATT RECT	P98
3126210141	29,5x59,2x0,85 cm	SOFT	P98
3122210141	29,5x59,2x0,80 cm	POL	P114
312B130141	59,2x59,2x0,85 cm	MATT RECT	P98
3126130141	59,2x59,2x0,85 cm	SOFT	P98
3122130141	59,2x59,2x0,80 cm	POL	P114

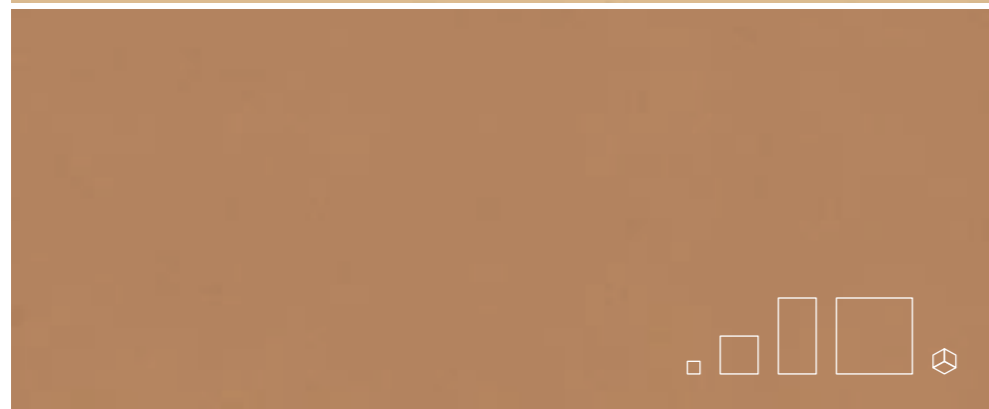

CROMÁTICA TOFFEE

31260835V1	(*)9,7x9,7x0,85 cm	SOFT	P119
312B1235V1	29,5x29,5x0,85 cm	MATT RECT	P98
31261235V1	29,5x29,5x0,85 cm	SOFT	P98
31221235V1	29,5x29,5x0,80 cm	POL	P114
312B2135V1	29,5x59,2x0,85 cm	MATT RECT	P98
31262135V1	29,5x59,2x0,85 cm	SOFT	P98
31222135V1	29,5x59,2x0,80 cm	POL	P114
312B1335V1	59,2x59,2x0,85 cm	MATT RECT	P98
31261335V1	59,2x59,2x0,85 cm	SOFT	P98
31221335V1	59,2x59,2x0,80 cm	POL	P114

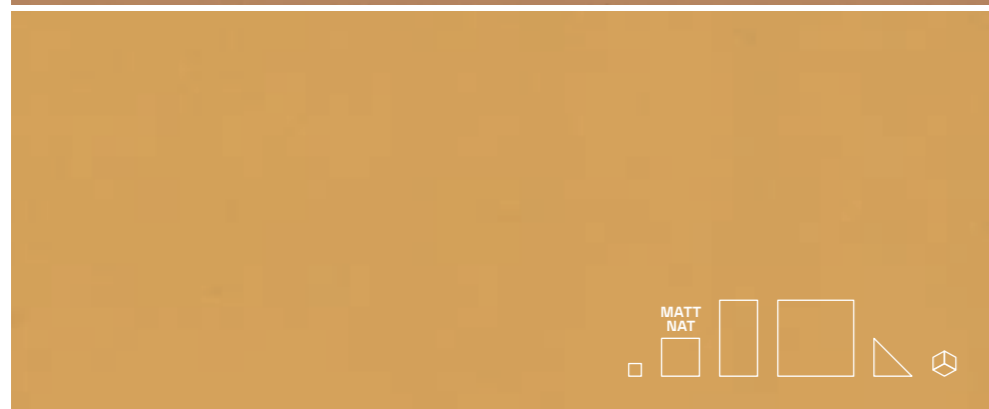

CROMÁTICA OCRES

3126080131	(*)9,7x9,7x0,85 cm	SOFT	P119
312A120131	30,0x30,0x0,77 cm	MATT NAT	P68
312B120131	29,5x29,5x0,85 cm	MATT RECT	P98
3126120131	29,5x29,5x0,85 cm	SOFT	P98
3711120131	29,5x29,5x0,80 cm	POL	P114
312B210131	29,5x59,2x0,85 cm	MATT RECT	P98
3126210131	29,5x59,2x0,85 cm	SOFT	P98
3122210131	29,5x59,2x0,80 cm	POL	P114
312B132Z01	59,2x59,2x0,85 cm	MATT RECT	P98
3126130131	59,2x59,2x0,85 cm	SOFT	P98
3122130131	59,2x59,2x0,80 cm	POL	P114



CROMÁTICA TERRACOTTA

3126088S11	(*)9,7x9,7x0,85 cm	SOFT	P143
3126138S11	59,2x59,2x0,85 cm	SOFT	P123
3122138S11	59,2x59,2x0,80 cm	POL	P137

29,5x29,5
29,5x59,2

Consultar tabela Cromática Level.
See the Cromatica Level table.
Consultez le tableau Cromatica Level.
Consulta la tabla Cromática Level.



CROMÁTICA CORAL

3126083S51	(*)9,7x9,7x0,85 cm	SOFT	P183
312B133S51	59,2x59,2x0,85 cm	MATT RECT	P163
3126133S51	59,2x59,2x0,85 cm	SOFT	P163
3122133S51	59,2x59,2x0,80 cm	POL	P177

29,5x29,5
29,5x59,2

Consultar tabela Cromática Level.
See the Cromatica Level table.
Consultez le tableau Cromatica Level.
Consulta la tabla Cromática Level.



CROMÁTICA BRICK

3126087S41	(*)9,7x9,7x0,85 cm	SOFT	P183
312B137S41	59,2x59,2x0,85 cm	MATT RECT	P163
3126137S41	59,2x59,2x0,85 cm	SOFT	P163
3122137S41	59,2x59,2x0,80 cm	POL	P177

29,5x29,5
29,5x59,2

Consultar tabela Cromática Level.
See the Cromatica Level table.
Consultez le tableau Cromatica Level.
Consulta la tabla Cromática Level.



CROMÁTICA ANIS

3126080241	(*)9,7x9,7x0,85 cm	SOFT	P143
312A120241	30,0x30,0x0,77 cm	MATT NAT	P92
312B120241	29,5x29,5x0,85 cm	MATT RECT	P123
3126120241	29,5x29,5x0,85 cm	SOFT	P123
3711120241	29,5x29,5x0,80 cm	POL	P137
312B215Z91	29,5x59,2x0,85 cm	MATT RECT	P123
3126210241	29,5x59,2x0,85 cm	SOFT	P123
3122210241	29,5x59,2x0,80 cm	POL	P137
312B130241	59,2x59,2x0,85 cm	MATT RECT	P123
3126130241	59,2x59,2x0,85 cm	SOFT	P123
3122130241	59,2x59,2x0,80 cm	POL	P137

CROMÁTICA JADE

3126080341	(*)9,7x9,7x0,85 cm	SOFT	P143
312B130341	59,2x59,2x0,85 cm	MATT RECT	P123
3126130341	59,2x59,2x0,85 cm	SOFT	P123
3122130341	59,2x59,2x0,80 cm	POL	P137

29,5x29,5
29,5x59,2

Consultar tabela Cromática Level.
See the Cromatica Level table.
Consultez le tableau Cromatica Level.
Consulta la tabla Cromática Level.



30x30 cm	MATT NAT	V1	5	class 2	A	R10	36+	≥0,42	—
29,5x29,5 · 59,2x59,2 cm	MATT RECT	V1	5	class 2	A	R10	36+	≥0,42	U4P4E3C2
9,7x9,7 · 29,5x29,5 · 59,2x59,2 cm	SOFT	V1	5	—	—	—	—	—	U4P4E3C2
29,5x29,5 · 29,5x59,2 · 59,2x59,2 · 59,2x118,6 · 88,9x88,9 cm	POL	V1	3	—	—	—	—	—	U3P3E3C2
29,5x59,2 · 88,9x88,9 · 59,2x118,6 cm	MATT RECT	V1	5	class 2	A	R10	36+	≥0,42	U4P3E3C2
29,5x59,2 · 88,9x88,9 · 59,2x118,6 cm	SOFT	V1	5	—	—	—	—	—	U4P3E3C2
59,2x59,2 cm 14mm	MATT RECT	V1	5	class 1	—	R9	—	≥0,42	U4P4SE3C2

(**) Exceto Cromática Toffee e formato 9,7x9,7 cm.

(**) Except Cromática Toffee and 9,7x9,7 cm format.

(**) Saute Cromática Toffee et format 9,7x9,7 cm.

(**) Excepto Cromática Toffee y formato 9,7x9,7 cm.

(*) Peças produzidas de acordo com quantidades mínimas de 5m².
(*) Pieces produced in minimum quantities of 5m².
(*) Pièces produites selon des quantités minimales de 5m².
(*) Piezas producidas en cantidades mínimas de 5m².

CROMÁTICA

FULL BODY

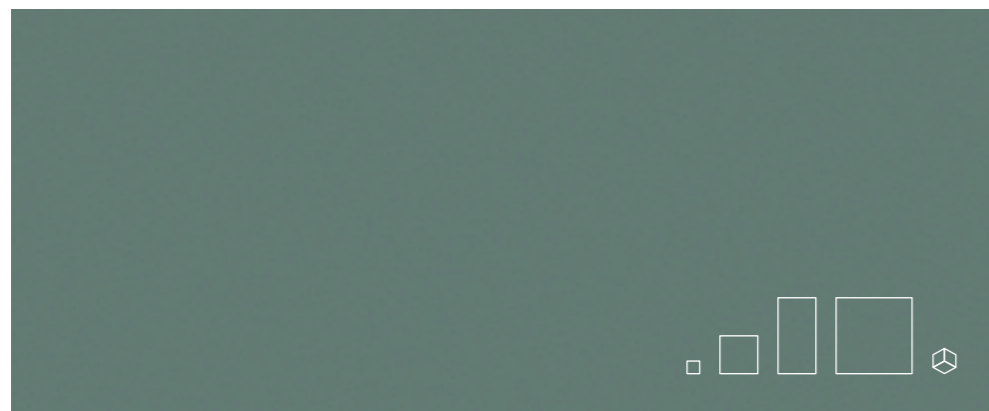

CROMÁTICA LAGOON

31260834V1	(*)9,7x9,7x0,85 cm	SOFT	P143
312B1234V1	29,5x29,5x0,85 cm	MATT RECT	P123
31261234V1	29,5x29,5x0,85 cm	SOFT	P123
31221234V1	29,5x29,5x0,80 cm	POL	P137
312B2134V1	29,5x59,2x0,85 cm	MATT RECT	P123
31262134V1	29,5x59,2x0,85 cm	SOFT	P123
31222134V1	29,5x59,2x0,80 cm	POL	P137
312B1334V1	59,2x59,2x0,85 cm	MATT RECT	P123
31261334V1	59,2x59,2x0,85 cm	SOFT	P123
31221334V1	59,2x59,2x0,80 cm	POL	P137

CROMÁTICA TEAL

3126088S01	(*)9,7x9,7x0,85 cm	SOFT	P183
3126138S01	59,2x59,2x0,85 cm	SOFT	P163
3122138S01	59,2x59,2x0,80 cm	POL	P177

29,5x29,5
29,5x59,2

Consultar tabela Cromática Level.
See the Cromatica Level table.
Consultez le tableau Cromatica Level.
Consulta la tabla Cromática Level.

CROMÁTICA OPALA

3126080251	(*)9,7x9,7x0,85 cm	SOFT	P143
312B130251	59,2x59,2x0,85 cm	MATT RECT	P123
3126130251	59,2x59,2x0,85 cm	SOFT	P123
3122130251	59,2x59,2x0,80 cm	POL	P137

29,5x29,5
29,5x59,2

Consultar tabela Cromática Level.
See the Cromatica Level table.
Consultez le tableau Cromatica Level.
Consulta la tabla Cromática Level.

CROMÁTICA PISTACHIO

3126083S71	(*)9,7x9,7x0,85 cm	SOFT	P183
312B133S71	59,2x59,2x0,85 cm	MATT RECT	P163
3126133S71	59,2x59,2x0,85 cm	SOFT	P163
3122133S71	59,2x59,2x0,80 cm	POL	P177

29,5x29,5
29,5x59,2

Consultar tabela Cromática Level.
See the Cromatica Level table.
Consultez le tableau Cromatica Level.
Consulta la tabla Cromática Level.

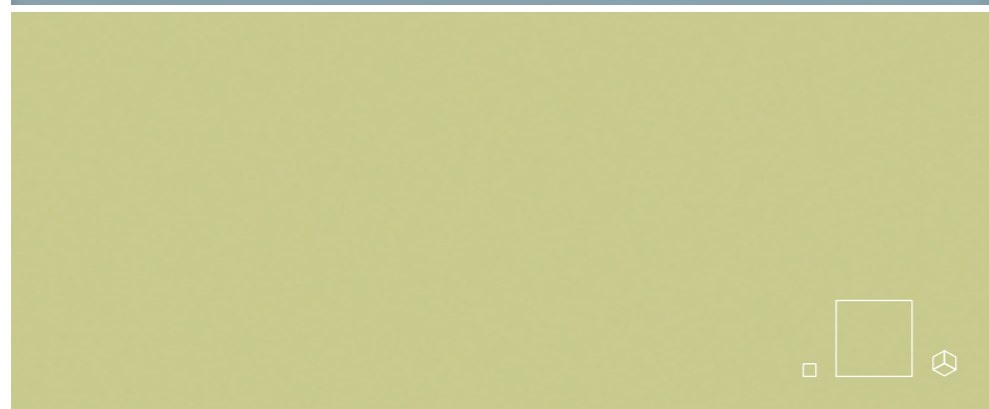
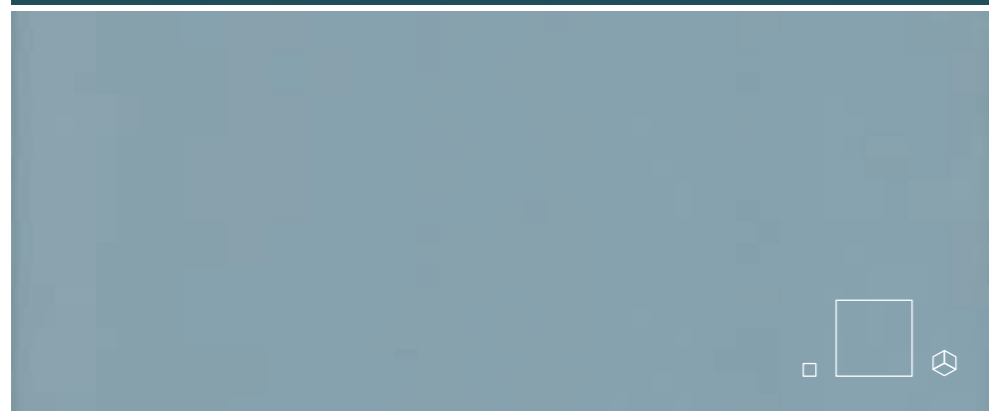

CROMÁTICA

FULL BODY

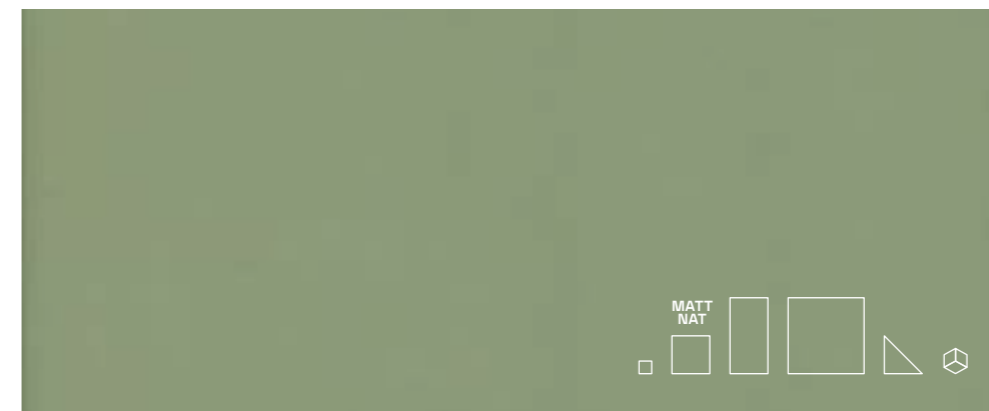

CROMÁTICA OLIVA

3126080321	(*)9,7x9,7x0,85 cm	SOFT	P119
312A120321	30,0x30,0x0,77 cm	MATT NAT	P68
312B120321	29,5x29,5x0,85 cm	MATT RECT	P98
3126120321	29,5x29,5x0,85 cm	SOFT	P98
3711120321	29,5x29,5x0,80 cm	POL	P114
312B210321	29,5x59,2x0,85 cm	MATT RECT	P98
3126210321	29,5x59,2x0,85 cm	SOFT	P98
3122210321	29,5x59,2x0,80 cm	POL	P114
312B130321	59,2x59,2x0,85 cm	MATT RECT	P98
3126130321	59,2x59,2x0,85 cm	SOFT	P98
3122130321	59,2x59,2x0,80 cm	POL	P114

CROMÁTICA PALM

3126087S91	(*)9,7x9,7x0,85 cm	SOFT	P183
3126137S91	59,2x59,2x0,85 cm	SOFT	P163
3122137S91	59,2x59,2x0,80 cm	POL	P177

29,5x29,5
29,5x59,2

Consultar tabela Cromática Level.
See the Cromatica Level table.
Consultez le tableau Cromatica Level.
Consulta la tabla Cromática Level.

CROMÁTICA INDIGO

3126087S61	(*)9,7x9,7x0,85 cm	SOFT	P289
3126137S61	59,2x59,2x0,85 cm	SOFT	P269
3122137S61	59,2x59,2x0,80 cm	POL	P283

29,5x29,5
29,5x59,2

Consultar tabela Cromática Level.
See the Cromatica Level table.
Consultez le tableau Cromatica Level.
Consulta la tabla Cromática Level.



CROMÁTICA COBALTO

3126080221	(*)9,7x9,7x0,85 cm	SOFT	P183
312B130221	59,2x59,2x0,85 cm	MATT RECT	P163
3126130221	59,2x59,2x0,85 cm	SOFT	P163
3122130221	59,2x59,2x0,80 cm	POL	P177

29,5x29,5
29,5x59,2

Consultar tabela Cromática Level.
See the Cromatica Level table.
Consultez le tableau Cromatica Level.
Consulta la tabla Cromática Level.



30x30 cm	MATT NAT	V1	5	class 2	A	R10	36+	≥0,42	—
29,5x29,5 · 59,2x59,2 cm	MATT RECT	V1	5	class 2	A	R10	36+	≥0,42	U4P4E3C2
9,7x9,7 · 29,5x29,5 · 59,2x59,2 cm	SOFT	V1	5	—	—	—	—	—	U4P4E3C2
29,5x29,5 · 29,5x59,2 · 59,2x59,2 · 59,2x118,6 · 88,9x88,9 cm	POL	V1	3	—	—	—	—	—	U3P3E3C2
29,5x59,2 · 88,9x88,9 · 59,2x118,6 cm	MATT RECT	V1	5	class 2	A	R10	36+	≥0,42	U4P3E3C2
29,5x59,2 · 88,9x88,9 · 59,2x118,6 cm	SOFT	V1	5	—	—	—	—	—	U4P3E3C2
59,2x59,2 cm 14mm	MATT RECT	V1	5	class 1	—	R9	—	≥0,42	U4P4SE3C2

(**) Exceto Cromática Lagoon e formato 9,7x9,7 cm.

(**) Except Cromática Lagoon and 9,7x9,7 cm format.

(**) Saute Cromática Lagoon et format 9,7x9,7 cm.

(**) Excepto Cromática Lagoon y formato 9,7x9,7 cm.

(*) Peças produzidas de acordo com quantidades mínimas de 5m².
(*) Pieces produced in minimum quantities of 5m².
(*) Pièces produites selon des quantités minimales de 5m².
(*) Piezas producidas en cantidades mínimas de 5m².

CROMÁTICA CHEVRON

9 cores
colours
couleurs
colores

2 formatos
formats
formats
formatos

1 acabamento
finish
finition
acabado

CHEVRON LEFT CROMÁTICA ICE

33216066T1	9,7x29,5x0,90 cm	SOFT	P469
3321669Y51	9,7x59,2x0,90 cm	SOFT	P395

CHEVRON LEFT CROMÁTICA SUPERBRANCO

332160U951	9,7x29,5x0,85 cm	SOFT	P341
332166U951	9,7x59,2x0,85 cm	SOFT	P289

CHEVRON LEFT CROMÁTICA BONE

33266045V1	9,7x29,5x0,85 cm	SOFT	P293
33266645V1	9,7x59,2x0,85 cm	SOFT	P249

CHEVRON LEFT CROMÁTICA QUARTZ

332160U061	9,7x29,5x0,85 cm	SOFT	P293
3321669Y81	9,7x59,2x0,85 cm	SOFT	P249

CHEVRON LEFT CROMÁTICA PLATINA

332160U031	9,7x29,5x0,85 cm	SOFT	P293
3321669Y71	9,7x59,2x0,85 cm	SOFT	P249

CHEVRON LEFT CROMÁTICA GRAFITE

332160U051	9,7x29,5x0,85 cm	SOFT	P293
3321669Y41	9,7x59,2x0,85 cm	SOFT	P249

CHEVRON LEFT CROMÁTICA ANTRACITE

332160U921	9,7x29,5x0,85 cm	SOFT	P293
332166U921	9,7x59,2x0,85 cm	SOFT	P249

CHEVRON LEFT CROMÁTICA PRETO

332160U941	9,7x29,5x0,85 cm	SOFT	P293
332166U941	9,7x59,2x0,85 cm	SOFT	P249

CHEVRON LEFT CROMÁTICA JET

33266013T1	9,7x29,5x0,85 cm	SOFT	P341
3321669Y61	9,7x59,2x0,85 cm	SOFT	P289

CHEVRON RIGHT CROMÁTICA ICE

33216014T1	9,7x29,5x0,90 cm	SOFT	P469
33216600Y1	9,7x59,2x0,90 cm	SOFT	P395

CHEVRON RIGHT CROMÁTICA SUPERBRANCO

332160U991	9,7x29,5x0,85 cm	SOFT	P341
332166U991	9,7x59,2x0,85 cm	SOFT	P289

CHEVRON RIGHT CROMÁTICA BONE

33266046V1	9,7x29,5x0,85 cm	SOFT	P293
33266646V1	9,7x59,2x0,85 cm	SOFT	P249

CHEVRON RIGHT CROMÁTICA QUARTZ

332160U201	9,7x29,5x0,85 cm	SOFT	P293
33216603Y1	9,7x59,2x0,85 cm	SOFT	P249

CHEVRON RIGHT CROMÁTICA PLATINA

332160U171	9,7x29,5x0,85 cm	SOFT	P293
33216602Y1	9,7x59,2x0,85 cm	SOFT	P249

CHEVRON RIGHT CROMÁTICA GRAFITE

332160U191	9,7x29,5x0,85 cm	SOFT	P293
3321669Y91	9,7x59,2x0,85 cm	SOFT	P249

CHEVRON RIGHT CROMÁTICA ANTRACITE

332160U961	9,7x29,5x0,85 cm	SOFT	P293
332166U961	9,7x59,2x0,85 cm	SOFT	P249

CHEVRON RIGHT CROMÁTICA PRETO

332160U981	9,7x29,5x0,85 cm	SOFT	P293
332166U981	9,7x59,2x0,85 cm	SOFT	P249

CHEVRON RIGHT CROMÁTICA JET

33216044T1	9,7x29,5x0,85 cm	SOFT	P341
33216601Y1	9,7x59,2x0,85 cm	SOFT	P289

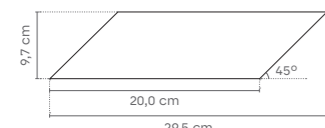

9,7x29,5x0,85 cm
[1m² = 52 peças_pieces]

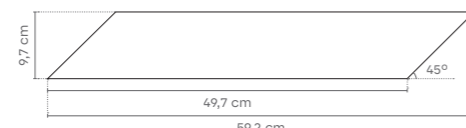

9,7x59,2x0,85 cm
[1m² = 21 peças_pieces]

Peças produzidas de acordo com quantidades mínimas de 5m².
Pieces produced in minimum quantities of 5m².
Pièces produites selon des quantités minimales de 5m².
Piezas producidas en cantidades mínimas de 5m².

CROMÁTICA HALF

8 cores
colours
couleurs
colores

1 formato
format
format
formato

1 acabamento
finish
finition
acabado



HALF CROMÁTICA SUPERBRANCO

3326N60071 29,5x29,5x41,7x0,85 cm SOFT P243



HALF CROMÁTICA BONE

3326N6S741 29,5x29,5x41,7x0,85 cm SOFT P197



HALF CROMÁTICA ALLOY

3326N67S31 29,5x29,5x41,7x0,85 cm SOFT P243



HALF CROMÁTICA QUARTZ

3326N62S61 29,5x29,5x41,7x0,85 cm SOFT P197



HALF CROMÁTICA GRAFITE

3326N60091 29,5x29,5x41,7x0,85 cm SOFT P197



HALF CROMÁTICA ANIS

3326N60241 29,5x29,5x41,7x0,85 cm SOFT P243



HALF CROMÁTICA OLIVA

3326N60321 29,5x29,5x41,7x0,85 cm SOFT P197



HALF CROMÁTICA OCRE

3326N60131 29,5x29,5x41,7x0,85 cm SOFT P197

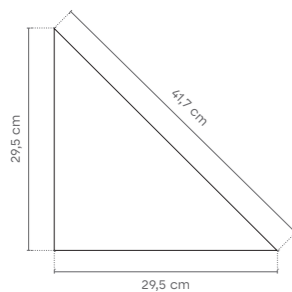

29,5x29,5x41,7x0,85 cm
[1m² = 22 peças/pieces]

Peças produzidas de acordo com quantidades mínimas de 5m².
Pièces produites en minimum quantités de 5m².
Piezas producidas en cantidades mínimas de 5m².

CROMÁTICA HALF



HALF ANIS _ HALF OCRE _ HALF SUPERBRANCO _ CROMÁTICA ANIS _ CROMÁTICA SUPERBRANCO _ DECK GRIS

CROMÁTICA TRIO

8 cores colours couleurs colores 1 formato format format formato 1 acabamento finish finition acabado



TRIO CHILL OUT (a)(f)

3126N87W81 20x22x0,85 cm SOFT P11 /peça_piece
Cromática: Bege + Superbranco + Astral

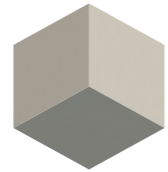

TRIO WINTER (a)(f)

3126N88W11 20x22x0,85 cm SOFT P11 /peça_piece
Cromática: Titanium + Alloy + Grafite



TRIO SUMMER NIGHT (a)(f)

3126N88W51 20x22x0,85 cm SOFT P14 /peça_piece
Cromática: Opala + Platina + Indigo

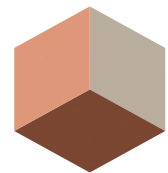

TRIO BLOOM (a)(f)

3126N88W31 20x22x0,85 cm SOFT P12 /peça_piece
Cromática: Coral + Quartz + Terracotta



TRIO SPRING SUN (a)(f)

3126N88W01 20x22x0,85 cm SOFT P11 /peça_piece
Cromática: Ocre + Bone + Oliva



TRIO FRESHY (a)(f)

3126N88W41 20x22x0,85 cm SOFT P12 /peça_piece
Cromática: Bone + Pistachio + Lagoon



TRIO AUTUMN (a)(f)

3126N88W21 20x22x0,85 cm SOFT P12 /peça_piece
Cromática: Palm + Bone + Brick



TRIO SAFARI (a)(f)

3126N87W91 20x22x0,85 cm SOFT P11 /peça_piece
Cromática: Bone + Astral + Toffee

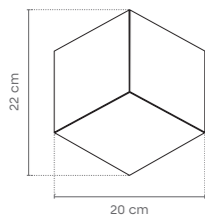

20,0x22,0x0,85 cm

[1m² = 32 peças_pieces]

CROMÁTICA TRIO

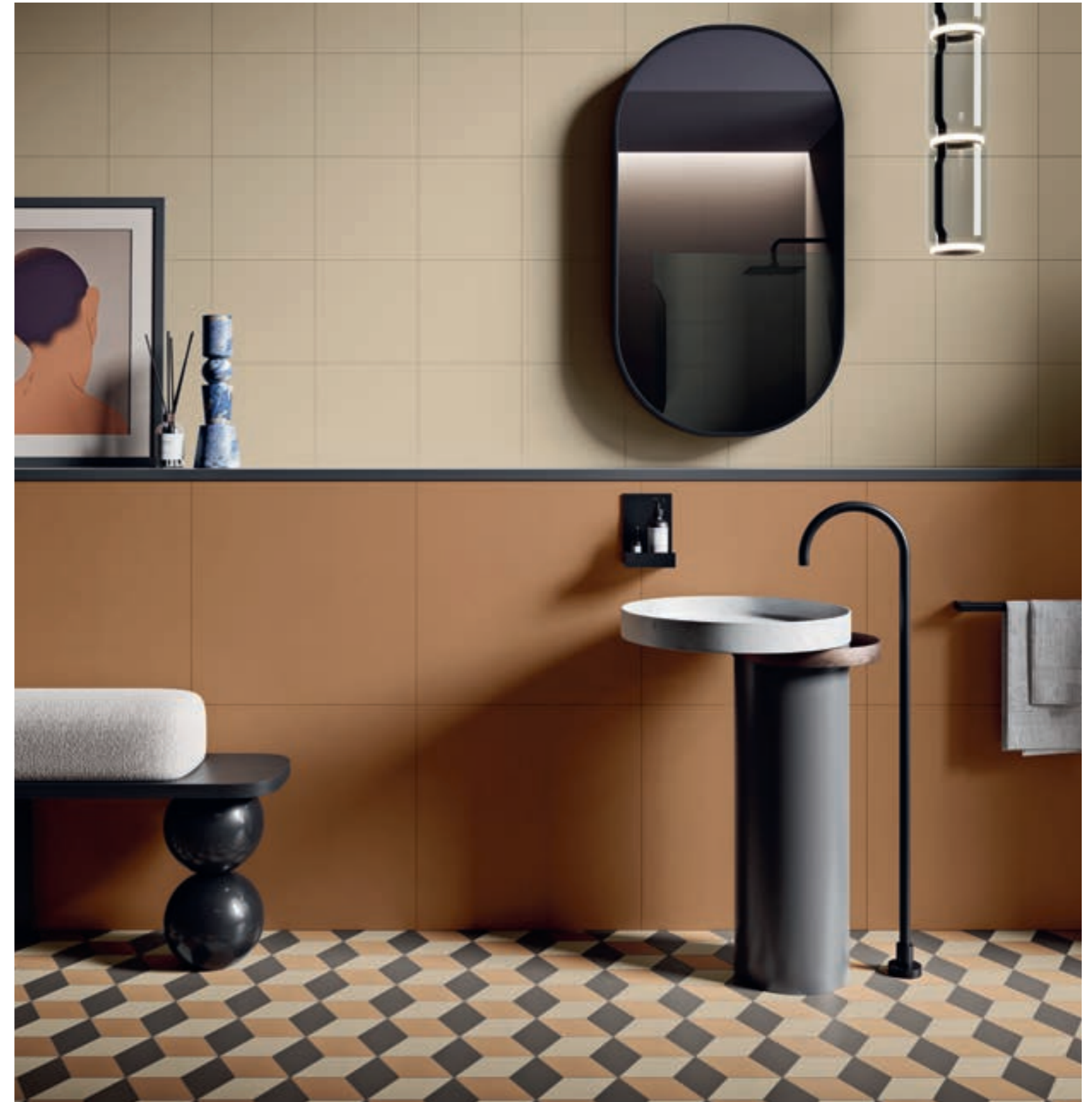

CROMÁTICA BONE _ CROMÁTICA TOFFEE _ TRIO SAFARI

CROSS _ LINEA _ SQUARE

CROMÁTICA

FULL BODY



CROSS 8 (*)

29,5x29,5x0,85 cm	MATT RECT	P(BASE) + P75
29,5x29,5x0,85 cm	SOFT	P(BASE) + P75
29,5x29,5x0,80 cm	POL	P(BASE) + P75

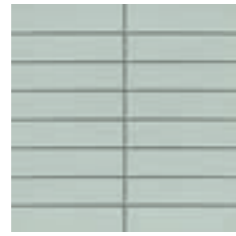

CROSS 16 (*)

29,5x29,5x0,85 cm	MATT RECT	P(BASE) + P81
29,5x29,5x0,85 cm	SOFT	P(BASE) + P81
29,5x29,5x0,80 cm	POL	P(BASE) + P81

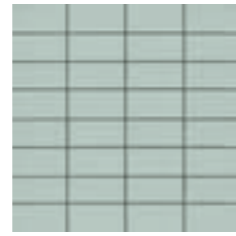

CROSS 32 (*)

29,5x29,5x0,85 cm	MATT RECT	P(BASE) + P89
29,5x29,5x0,85 cm	SOFT	P(BASE) + P89
29,5x29,5x0,80 cm	POL	P(BASE) + P89



LINEA 2 (*)

29,5x29,5x0,85 cm	MATT RECT	P(BASE) + P63
29,5x29,5x0,85 cm	SOFT	P(BASE) + P63
29,5x29,5x0,80 cm	POL	P(BASE) + P63
29,5x59,2x0,85 cm	MATT RECT	P(BASE) + P68
29,5x59,2x0,85 cm	SOFT	P(BASE) + P68
29,5x59,2x0,80 cm	POL	P(BASE) + P68



LINEA 4 (*)

29,5x29,5x0,85 cm	MATT RECT	P(BASE) + P67
29,5x29,5x0,85 cm	SOFT	P(BASE) + P67
29,5x29,5x0,80 cm	POL	P(BASE) + P67
29,5x59,2x0,85 cm	MATT RECT	P(BASE) + P72
29,5x59,2x0,85 cm	SOFT	P(BASE) + P72
29,5x59,2x0,80 cm	POL	P(BASE) + P72



LINEA 8 (*)

29,5x29,5x0,85 cm	MATT RECT	P(BASE) + P73
29,5x29,5x0,85 cm	SOFT	P(BASE) + P73
29,5x29,5x0,80 cm	POL	P(BASE) + P73
29,5x59,2x0,85 cm	MATT RECT	P(BASE) + P78
29,5x59,2x0,85 cm	SOFT	P(BASE) + P78
29,5x59,2x0,80 cm	POL	P(BASE) + P78



SQUARE 4 (*)

29,5x29,5x0,85 cm	MATT RECT	P(BASE) + P73
29,5x29,5x0,85 cm	SOFT	P(BASE) + P73
29,5x29,5x0,80 cm	POL	P(BASE) + P73



SQUARE 16 (*)

29,5x29,5x0,85 cm	MATT RECT	P(BASE) + P77
29,5x29,5x0,85 cm	SOFT	P(BASE) + P77
29,5x29,5x0,80 cm	POL	P(BASE) + P77

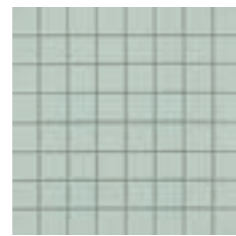

SQUARE 64 (*)

29,5x29,5x0,85 cm	MATT RECT	P(BASE) + P89
29,5x29,5x0,85 cm	SOFT	P(BASE) + P89
29,5x29,5x0,80 cm	POL	P(BASE) + P89

(*) Peças produzidas de acordo com quantidades mínimas de 5m².
 (*) Pieces produced in minimum quantities of 5m².
 (*) Pièces produites selon des quantités minimales de 5m².
 (*) Piezas producidas en cantidades mínimas de 5m².

Estes efeitos – cross, linea e square – podem ser realizados, sob encomenda, para outras Coleções. O cálculo do preço total de cada efeito por m² obtém-se, adicionando ao preço da base, o preço ("P") respectivo de cada efeito, ajustado ao escalão da Tabela de Grupos (P's).
 Exemplo: o preço de Square 16 Cromática Anis Matt Rect 30x30 é: P123+P77 = P169.

The Linea, Cross and Square effects are available, upon order, for other collections. The total price for each effect per m² is the sum of the base price plus the respective price ("P") for each effect, adjusted to the category of the Groups Price List (P's).
 For example: the price for Square 16 Cromática Anis Matt Rect 30x30 is: P123+P77 = P169.

Ces effets – cross, linea, square – peuvent être réalisés sur commande pour d'autres collections. Le calcul du prix total de chaque effet au m² s'obtient en additionnant au prix de base, le prix ("P") de chaque effet, ajusté selon l'échelon du Tableau de Groupes (P's).
 Exemple: Le prix de Square 16 Cromática Anis Matt Rect 30x30 est le suivant: P123+P77 = P169.

Estos efectos – cross, linea y square – pueden realizarse en otras colecciones bajo petición. El cálculo del precio total de cada efecto por m² se obtiene añadiendo al precio base el precio ("P") respectivo de cada efecto, según la Tabla de Grupos (P's).
 Ejemplo: el precio de la Square 16 Cromática Anis Matt Rect 30x30 sería: P123+P77 = P169.

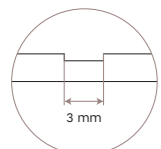

Peças com pré-corte de 3mm de largura.
 3mm wide pre-cut pieces.
 Pièces prédécoupées de 3 mm de large.
 Piezas precortadas de 3 mm de ancho.

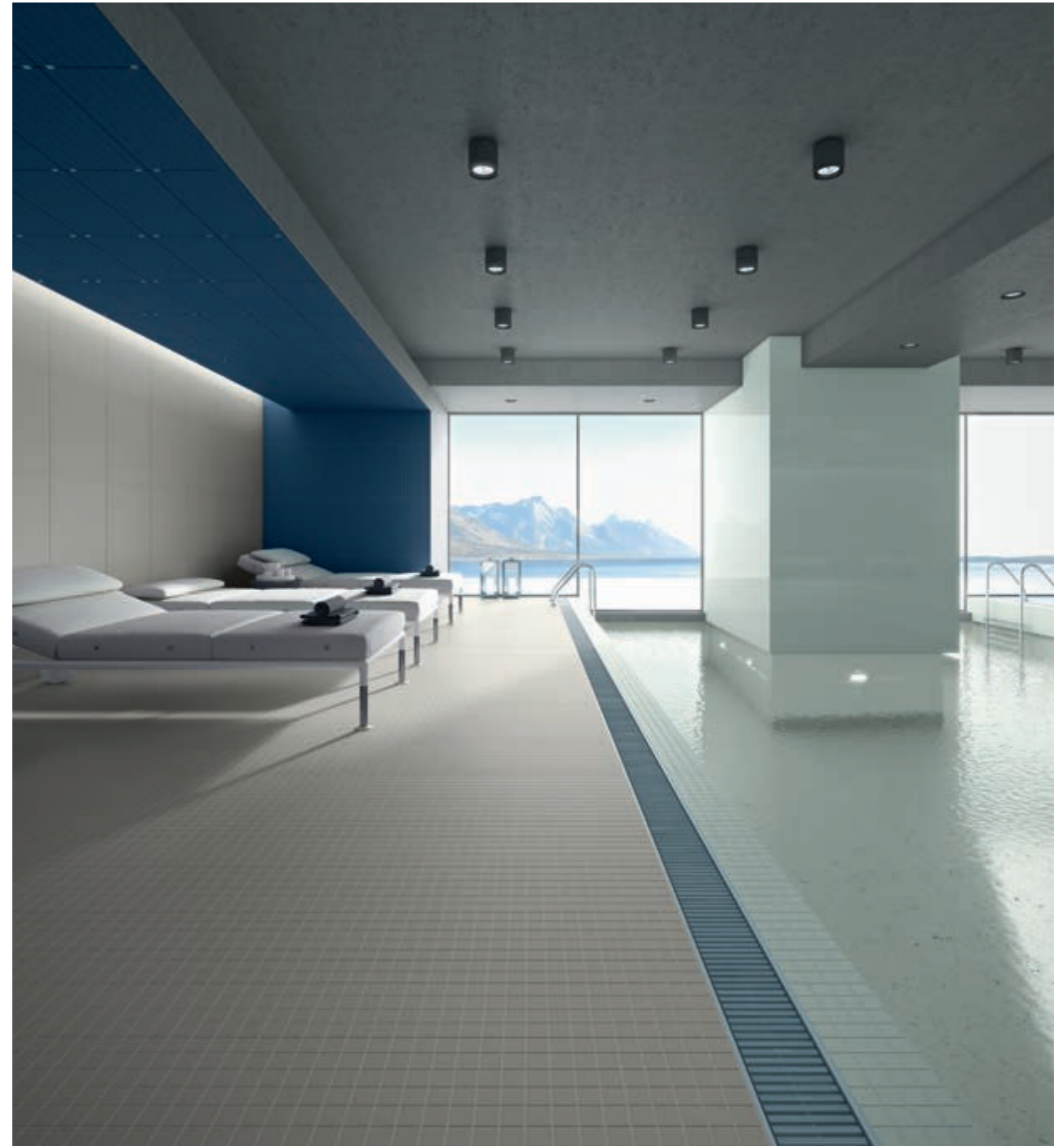

FULL BODY

45

SQUARE 16 CROMÁTICA ANIS _ SQUARE 16 CROMÁTICA GRAFITE _ LINEA 8 CROMÁTICA INDIGO



CROMÁTICA TEXTURES



CROMÁTICA TEXTURES

EPOQUE

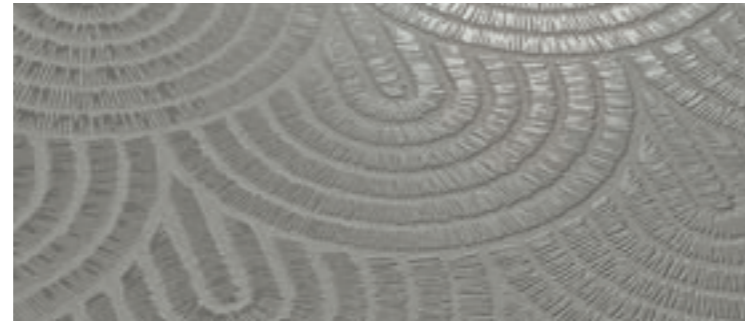
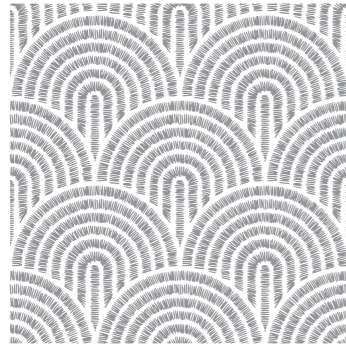

Epoque Cromática Grafite 29,5x29,5 cm SOFT

SCALY

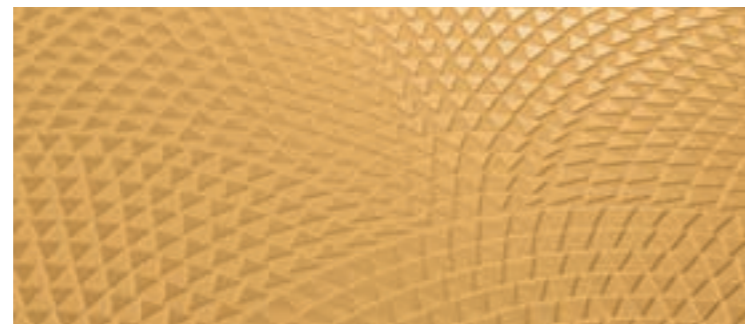
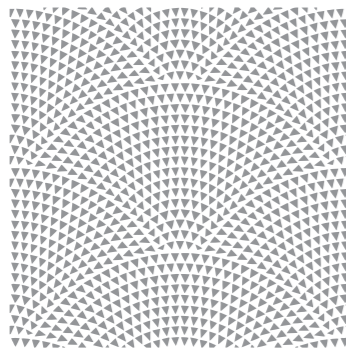

Scaly Cromática Ocre 29,5x29,5 cm SOFT

ENIGMA

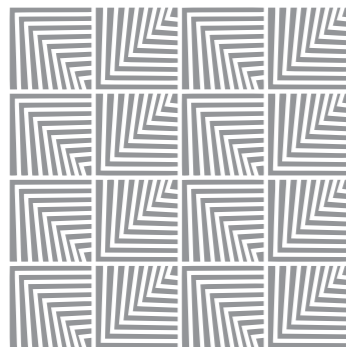

Enigma Cromática Terracotta 29,5x29,5 cm SOFT

CUBIC

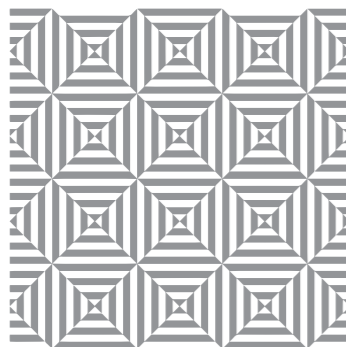

Cubic Cromática Opala 29,5x29,5 cm SOFT

ILLUSION



Illusion Cromática Quartz 29,5x29,5 cm SOFT

LINES

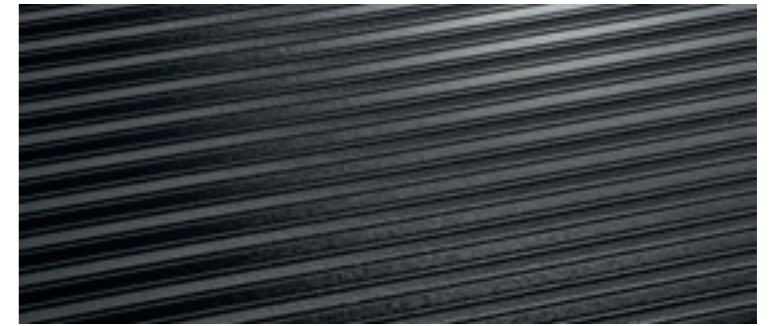
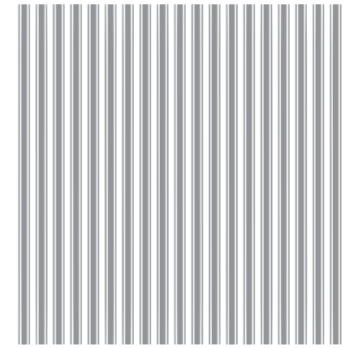

Lines Cromática Jet 29,5x29,5 cm SOFT

LAUREL



Laurel Cromática Palm 29,5x29,5 cm SOFT

ARABESQUE

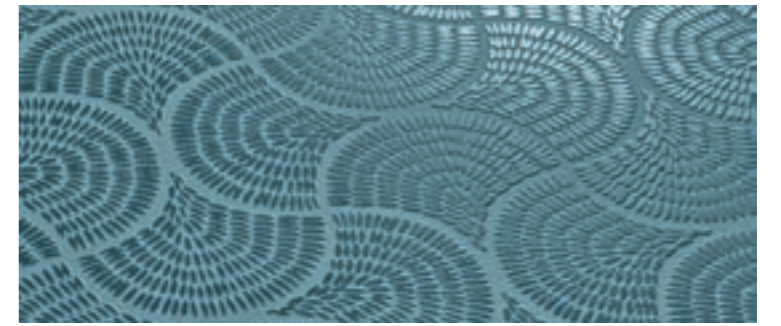
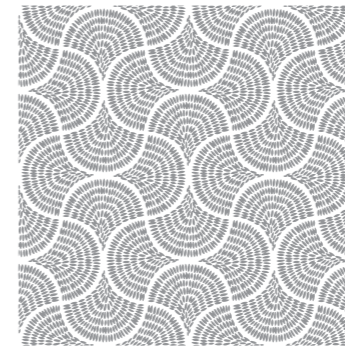

Arabesque Cromática Teal 29,5x29,5 cm SOFT

ETHNIC

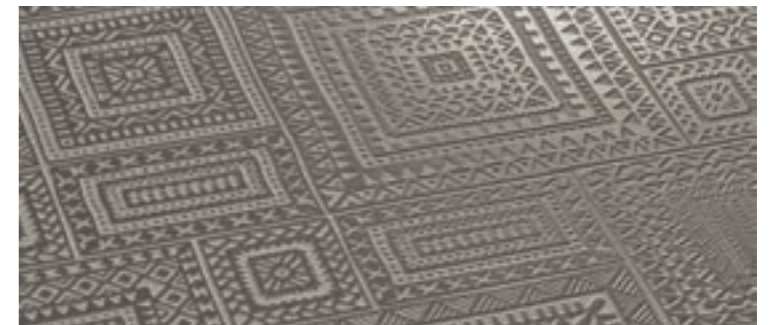
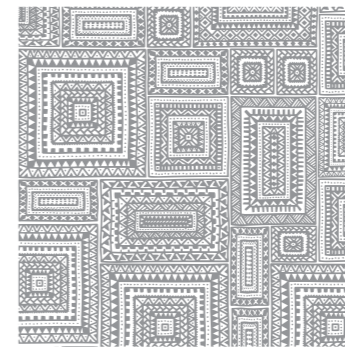

Ethnic Cromática Astral 29,5x29,5 cm SOFT

TEXTURES: peças personalizáveis mediante a escolha do efeito (9 texturas), cor Cromática (30 cores) e formato (29,5x29,5 / 29,5x59,2 / 59,2x59,2 / 59,2x118,6 / 88,9x88,9cm), com acabamento SOFT. **Peças produzidas mediante consulta.**

TEXTURES: To customize your tiles choose the effect (9 textures), colour (30 Cromática colours) and size (29,5x29,5 / 29,5x59,2 / 59,2x59,2 / 59,2x118,6 / 88,9x88,9cm) with SOFT finish. **Pieces produced under inquiry.**

TEXTURES: Pièces personnalisables en choisissant l'effet (9 textures), la couleur Cromática (30 couleurs) et le format (29,5x29,5 / 29,5x59,2 / 59,2x59,2 / 59,2x118,6 / 88,9x88,9cm), avec la finition SOFT. **Pièces fabriquées sur demande.**

TEXTURES: Piezas personalizables eligiendo el efecto (9 texturas), color Cromática (30 colores) y formato (29,5x29,5 / 29,5x59,2 / 59,2x59,2 / 59,2x118,6 / 88,9x88,9cm), en el acabado SOFT. **Piezas producidas por encargo.**

Recomendado para revestimento. Recomenda-se a aplicação de um hidro-óleo repelente antes do rejuntamento (FILA FOB ou similar).
Recommended for wall use. We recommend applying a repellent hydro-oil before grouting (FILA FOB or similar).
Recommandé pour revêtement mural. Il est conseillé d'appliquer un hydrofuge / oléofuge avant de rejointer (FILA FOB ou similaire).
Recomendado para revestimiento. Se recomienda aplicar un repelente de agua y lubricante antes del rejuntado (FILA FOB o similar).

CROMÁTICA

FULL BODY

PEÇAS · PIECES				CAIXA · BOX			EUROPALETE · EUROPALLET		
			$\frac{1}{2}$	PZ	M²	KG	CX	M²	KG
9,7x9,7 cm (*)	SOFT		8,5 ±5%	32	0.30	5.8	180	54.00	1 065
9,7x29,5 cm (*)	SOFT	Chevron	8,5 ±5%	36	0.69	15.4	36	24.84	575
9,7x59,2cm (*)	SOFT	Chevron	8,5 ±5%	15	0.71	14.2	50	35.50	731
20x22 cm	SOFT	Trio	8,5 ±5%	10	-	10.0	36	-	381
29,5x29,5x41,7 (*)	SOFT	Half	8,5 ±5%	22	1.00	19.1	36	36.00	709
29,5x29,5 cm	NAT · MATT NAT	Cromática	7,7 ±5%	16	1.44	28.0	40	57.50	1 141
	MATT RECT · SOFT	Cromática	8,5 ±5%	16	1.39	28.0	40	55.60	1 173
	MATT RECT · SOFT	Cromática Ice	9,0 ±5%	16	1.39	33.6	40	55.60	1 365
	MATT RECT · SOFT	Cross, Linea, Square (*)	8,5 ±5%	11	1.00	16.5	45	45.00	764
	POL	Cromática	8,0 ±5%	16	1.39	25.6	40	55.60	1 045
	POL	Cromática Ice	8,5 ±5%	16	1.39	30.1	40	55.60	1 224
29,5x59,2 cm	POL	Cross, Linea, Square (*)	8,0 ±5%	11	1.00	16.0	45	45.00	741
	MATT RECT · SOFT	Cromática	8,5 ±5%	8	1.40	28.8	32	46.08	943
	MATT RECT · SOFT	Cromática Ice	9,0 ±5%	8	1.40	33.6	32	44.80	1 096
	MATT RECT · SOFT	Linea (*)	8,5 ±5%	7	1.25	26.5	24	30.00	657
	POL	Cromática	8,0 ±5%	8	1.40	25.6	40	56.00	1 045
	POL	Cromática Ice	8,5 ±5%	8	1.40	30.1	32	44.80	984
59,2x59,2 cm	POL	Linea (*)	8,0 ±5%	7	1.25	25.0	24	30.00	621
	MATT RECT · SOFT	Cromática	8,5 ±5%	4	1.40	28.7	36	50.40	1 054
	MATT RECT · SOFT	Cromática Ice	9,0 ±5%	4	1.40	33.5	36	50.40	1 227
	MATT RECT	Cromática 14 mm	14,0 ±0,5 mm	3	1.05	34.2	32	33.60	1 115
	POL	Cromática	8,0 ±5%	4	1.40	26.7	36	50.40	982
	POL	Cromática Ice	8,5 ±5%	4	1.40	30.0	36	50.40	1 101
59,2x118,6 cm	MATT RECT · SOFT	Cromática	9,8 ±5%	2	1.40	33.0	30	42.00	1 011
	POL	Cromática	9,3 ±5%	2	1.40	31.0	30	42.00	951
87x87 cm	MATT RECT · SOFT	Cromática Ice	10,5 ±0,5mm	2	1.50	39.0	24	36.00	957
	POL	Cromática Ice	9,8 ±5%	2	1.50	37.0	24	36.00	909
88,9x88,9 cm	MATT RECT · SOFT	Cromática	10,5 ±0,5 mm	2	1.58	39.0	24	37.92	957
	POL	Cromática	9,8 ±5%	2	1.58	37.0	24	37.92	909



50

CROMÁTICA INDIGO _ DI ALBA STONE CARBON

De modo a proteger a superfície das peças, os produtos no acabamento polido têm uma fina camada de impermeabilizante, que apenas deve ser removida após a conclusão da obra.

Tiles with polished finish are protected with waterproof coating that must be removed only after the works are concluded.

En vue de protéger la surface des pièces, les produits à la finition polie ont une fine couche d'imperméabilisant qui ne devrait être enlevée qu'après l'achèvement des travaux.

Con el fin de proteger la superficie de las piezas, los productos con acabado pulido tienen una fina capa de impermeabilizante, que solo debe eliminarse una vez terminado el trabajo.

(*) Peças produzidas de acordo com quantidades mínimas de 5m².

(*) Pieces produced in minimum quantities of 5m².

(*) Pièces produites selon des quantités minimales de 5m².

(*) Piezas producidas en cantidades mínimas de 5m².

revigres

CROMÁTICA

FULL BODY



		PEÇA · PIECE		
DG		MATT NAT	MATT RECT SOFT	POL
29,5x29,5 cm	Cromática Antracite, Cromática Bege, Cromática Bone, Cromática Grafite, Cromática Ocre, Cromática Oliva, Cromática Platina, Cromática Quartz, Cromática Titanium	P08	P10	P10
	Cromática Alloy, Cromática Anis, Cromática Jet, Cromática Superbranco	P09	P13	P13
	Cromática Ice	-	P20	P20
Geral / General / Général / Standard / General		-	P18	P18
29,5x59,2 cm	Cromática Alloy, Cromática Anis, Cromática Jade, Cromática Jet, Cromática Opala, Cromática Superbranco, Cromática Terracotta	-	P24	P24
	Cromática Brick, Cromática Cobalto, Cromática Coral, Cromática Palm, Cromática Pistachio, Cromática Teal	-	P36	P36
	Cromática Ice	-	P42	P42
	Cromática Indigo	-	P96	P96
29,5x59,2x1,4 cm	Cromática Arg Prata, Cromática Astral, Cromática Bone, Cromática Grafite, Cromática Preto	-	P26	-
	Cromática Superbranco	-	P32	-
Geral / General / Général / Standard / General		-	P36	P36
9,2x59,2 cm	Cromática Alloy, Cromática Anis, Cromática Jade, Cromática Jet, Cromática Opala, Cromática Superbranco, Cromática Terracotta	-	P46	P46
	Cromática Brick, Cromática Cobalto, Cromática Coral, Cromática Palm, Cromática Pistachio, Cromática Teal	-	P106	P106
	Cromática Ice	-	P118	P118
59,2x59,2x1,4 cm	Cromática Indigo	-	P157	P157
	Cromática Arg Prata, Cromática Astral, Cromática Bone, Cromática Grafite, Cromática Preto	-	P48	-
	Cromática Superbranco	-	P91	-
43,4x87,0 cm	Cromática Ice	-	P131	P131
44,35x88,9 cm	Cromática Jet, Cromática Preto, Cromática Superbranco	-	P96	P96
29,5x118,6 cm	Cromática Preto, Cromática Superbranco	-	P96	P96
59,2x118,6 cm	Cromática Preto, Cromática Superbranco	-	P167	P167

		PEÇA · PIECE	
DG CF		MATT RECT SOFT	POL
Geral / General / Général / Standard / General		P157	P157
29,5x59,2 cm	Cromática Brick, Cromática Ice	P197	P197
	Cromática Indigo	P237	P237

		PEÇA · PIECE	
DG CF CANTO		MATT RECT SOFT	POL
Geral / General / Général / Standard / General		P207	P207
29,5x59,2 cm	Cromática Brick, Cromática Ice	P247	P247
	Cromática Indigo	P287	P287

		PEÇA · PIECE		
RB		MATT NAT	MATT RECT SOFT	POL
9,5x29,5 cm	Cromática Alloy, Cromática Anis, Cromática Antracite, Cromática Bege, Cromática Bone, Cromática Grafite, Cromática Jet, Cromática Luna, Cromática Ocre, Cromática Oliva, Cromática Platina, Cromática Preto, Cromática Quartz, Cromática Superbranco, Cromática Titanium	P07	P08	P08
	Cromática Ice	-	P10	P10
8x43,4 cm	Cromática Ice	-	P20	P20
8x44,35 cm	Cromática Jet, Cromática Preto, Cromática Superbranco	-	P16	P16
Geral / General / Général / Standard / General		-	P12	P12
8x59,2 cm	Cromática Brick, Cromática Cobalto, Cromática Coral, Cromática Ice, Cromática Palm, Cromática Pistachio, Cromática Teal	-	P20	P20
	Cromática Indigo	-	P28	P28
8x87,0 cm	Cromática Ice	-	P36	P36
8x88,9 cm	Cromática Jet, Cromática Preto, Cromática Superbranco	-	P28	P28
8x118,6 cm	Cromática Preto, Cromática Superbranco	-	P28	P28

		PEÇA · PIECE		
BR		MATT NAT	MATT RECT SOFT	POL
7x29,5 cm	Cromática Alloy, Cromática Anis, Cromática Antracite, Cromática Bege, Cromática Bone, Cromática Grafite, Cromática Jet, Cromática Ocre, Cromática Oliva, Cromática Platina, Cromática Preto, Cromática Quartz, Cromática Superbranco, Cromática Titanium	P05	P06	P06
	Cromática Ice	-	P08	P08
Geral / General / Général / Standard / General		-	P09	P09
7x59,2 cm	Cromática Brick, Cromática Cobalto, Cromática Coral, Cromática Ice, Cromática Palm, Cromática Pistachio, Cromática Teal	-	P12	P12
	Cromática Indigo	-	P21	P21

		PEÇA · PIECE	
DG CF SS		MATT RECT SOFT	POL
Geral / General / Général / Standard / General		P157	P157
29,5x59,2 cm	Cromática Brick, Cromática Ice	P197	P197
	Cromática Indigo	P237	P237

		PEÇA · PIECE	
TC		MATT RECT SOFT	POL
Geral / General / Général / Standard / General		P01	P02
7x7 cm	Cromática Brick, Cromática Cobalto, Cromática Coral, Cromática Ice, Cromática Palm, Cromática Pistachio, Cromática Teal	P02	P04
	Cromática Indigo	P04	P05

DG CF / DG CF Canto/DG CF SS: Peças produzidas sob encomenda. Altura do focinho: entre 3 cm e 10 cm. Indicar a altura pretendida no ato da encomenda.

DG CF / DG CF Canto/DG CF SS: Pieces produced on order. Trim height: 3 to 10 cm. Specify desired height when placing a order.

DG CF / DG CF Canto/DG CF SS: Pièces produites sur commande. Hauteur du nez de marche : entre 3 cm et 10 cm. Préciser la hauteur souhaitée lors de la commande.

DG CF / DG CF Canto/DG CF SS: Piezas producidas por encargo. Altura del ángulo: entre 3 y 10 cm. Indicar la altura deseada al realizar el pedido.

DG CF Canto: Disponível em canto esquerdo e direito.

DG CF Canto: Available in left and right corner.

DG CF Canto: Disponible en angle gauche et droit.

DG CF Canto: Canto izquierdo y derecho disponibles.

51

revigres



FULL-BODY

OMNI

6 cores colours couleurs colores 5 formatos formats formats 4 acabamentos finishes finitions acabados



Elevada resistência e durabilidade unem-se ao design para dar resposta aos projetos arquitetónicos mais exigentes.

High resistance and durability combined with design, intended for demanding architectural projects.

Haute résistance et durabilité s'allient au design pour répondre aux projets architecturaux les plus exigeants.

Una elevada resistencia y durabilidad se alian al diseño para dar respuesta a los proyectos arquitectónicos más exigentes.

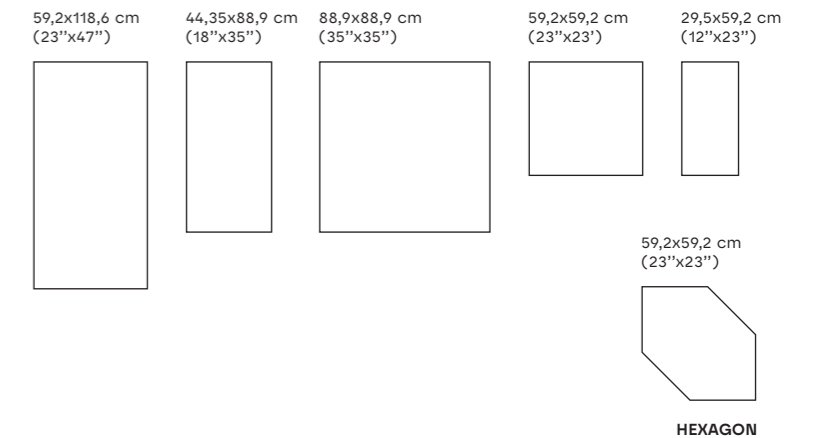

MATT RECT · SOFT · POL · ESTR

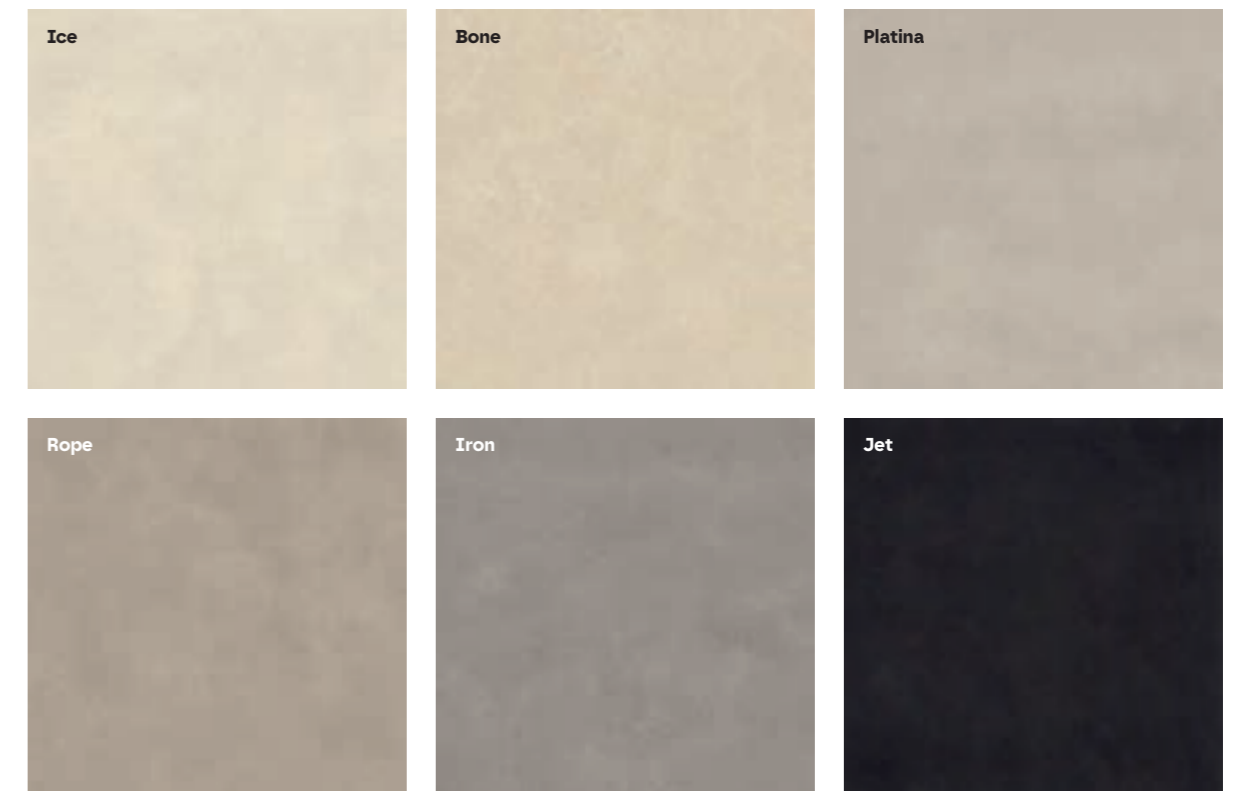





OMNI ICE

312B2183U1	29,5x59,2x0,98 cm	MATT RECT	P105
31261383U1	29,5x59,2x0,98 cm	SOFT	P105
31222183U1	29,5x59,2x0,93 cm	POL	P119
312B1383U1	59,2x59,2x0,98 cm	MATT RECT	P105
31261383U1	59,2x59,2x0,98 cm	SOFT	P105
31221383U1	59,2x59,2x0,93 cm	POL	P119
312BD383U1	59,2x118,6x0,98 cm	MATT RECT	P120
3126D383U1	59,2x118,6x0,98 cm	SOFT	P120
3122D383U1	59,2x118,6x0,93 cm	POL	P137
312BH883U1	44,35x88,9x1,05 cm	MATT RECT	P114
3126H883U1	44,35x88,9x1,05 cm	SOFT	P114
3122H883U1	44,35x88,9x0,98 cm	POL	P130
312BK783U1	88,9x88,9x1,05 cm	MATT RECT	P120
3126K783U1	88,9x88,9x1,05 cm	SOFT	P120
3122K783U1	88,9x88,9x0,98 cm	POL	P137

HEXAGON OMNI ICE (*)

332B13V261	59,2x59,2x0,98 cm	MATT RECT	P155
332613V261	59,2x59,2x0,98 cm	SOFT	P155

OMNI ICE ESTR

31211395U1	59,2x59,2x0,98 cm	RECT	P105
------------	-------------------	------	------

OMNI BONE

312B2182U1	29,5x59,2x0,98 cm	MATT RECT	P102
31262182U1	29,5x59,2x0,98 cm	SOFT	P102
31222182U1	29,5x59,2x0,93 cm	POL	P112
312B1382U1	59,2x59,2x0,98 cm	MATT RECT	P102
31261382U1	59,2x59,2x0,98 cm	SOFT	P102
31221382U1	59,2x59,2x0,93 cm	POL	P112
312BD382U1	59,2x118,6x0,98 cm	MATT RECT	P116
3126D382U1	59,2x118,6x0,98 cm	SOFT	P116
3122D382U1	59,2x118,6x0,93 cm	POL	P134
312BH882U1	44,35x88,9x1,05 cm	MATT RECT	P110
3126H882U1	44,35x88,9x1,05 cm	SOFT	P110
3122H882U1	44,35x88,9x0,98 cm	POL	P127
312BK782U1	88,9x88,9x1,05 cm	MATT RECT	P116
3126K782U1	88,9x88,9x1,05 cm	SOFT	P116
3122K782U1	88,9x88,9x0,98 cm	POL	P134

HEXAGON OMNI BONE (*)

332B13V251	59,2x59,2x0,98 cm	MATT RECT	P149
332613V251	59,2x59,2x0,98 cm	SOFT	P149

OMNI BONE ESTR

31211394U1	59,2x59,2x0,98 cm	RECT	P102
------------	-------------------	------	------



MOLTI (a)(f)

29,5x29,5x0,98 cm	MATT RECT	P22 /peça_pieza
-------------------	-----------	-----------------

[1m² = 11 peças_pieces]

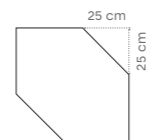

HEXAGON

[1m² = 3,4 peças_pieces]

Estruturado _ Structured: Produtos que minimizam o risco de deslizamento.
Estruturado _ Structured: Products that minimize the risk of slipping.
Estruturado _ Structured: Produits qui réduisent le risque de glissement.
Estruturado _ Structured: Productos que minimizan el riesgo de deslizamiento.
 (*) Peças produzidas de acordo com quantidades mínimas de 10m².
 (*) Pieces produced in minimum quantities of 10m².
 (*) Pièces produites selon des quantités minimales de 10m².
 (*) Piezas producidas en cantidades mínimas de 10m².



OMNI PLATINA

312B2186U1	29,5x59,2x0,98 cm	MATT RECT	P96
31262186U1	29,5x59,2x0,98 cm	SOFT	P96
31222186U1	29,5x59,2x0,93 cm	POL	P107
312B1386U1	59,2x59,2x0,98 cm	MATT RECT	P96
31261386U1	59,2x59,2x0,98 cm	SOFT	P96
31221386U1	59,2x59,2x0,93 cm	POL	P107
312BD386U1	59,2x118,6x0,98 cm	MATT RECT	P110
3126D386U1	59,2x118,6x0,98 cm	SOFT	P110
3122D386U1	59,2x118,6x0,93 cm	POL	P127
312BH886U1	44,35x88,9x1,05 cm	MATT RECT	P103
3126H886U1	44,35x88,9x1,05 cm	SOFT	P103
3122H886U1	44,35x88,9x0,98 cm	POL	P120
312BK786U1	88,9x88,9x1,05 cm	MATT RECT	P110
3126K786U1	88,9x88,9x1,05 cm	SOFT	P110
3122K786U1	88,9x88,9x0,98 cm	POL	P127

HEXAGON OMNI PLATINA (*)

332B13V291	59,2x59,2x0,98 cm	MATT RECT	P143
332613V291	59,2x59,2x0,98 cm	SOFT	P143

OMNI PLATINA ESTR

31211398U1	59,2x59,2x0,98 cm	RECT	P96
------------	-------------------	------	-----

OMNI ROPE

312B2187U1	29,5x59,2x0,98 cm	MATT RECT	P96
31262187U1	29,5x59,2x0,98 cm	SOFT	P96
31222187U1	29,5x59,2x0,93 cm	POL	P107
312B1387U1	59,2x59,2x0,98 cm	MATT RECT	P96
31261387U1	59,2x59,2x0,98 cm	SOFT	P96
31221387U1	59,2x59,2x0,93 cm	POL	P107
312BD387U1	59,2x118,6x0,98 cm	MATT RECT	P110
3126D387U1	59,2x118,6x0,98 cm	SOFT	P110
3122D387U1	59,2x118,6x0,93 cm	POL	P127
312BH887U1	44,35x88,9x1,05 cm	MATT RECT	P103
3126H887U1	44,35x88,9x1,05 cm	SOFT	P103
3122H887U1	44,35x88,9x0,98 cm	POL	P120
312BK787U1	88,9x88,9x1,05 cm	MATT RECT	P110
3126K787U1	88,9x88,9x1,05 cm	SOFT	P110
3122K787U1	88,9x88,9x0,98 cm	POL	P127

HEXAGON OMNI ROPE (*)

332B13V301	59,2x59,2x0,98 cm	MATT RECT	P143
332613V301	59,2x59,2x0,98 cm	SOFT	P143

OMNI ROPE ESTR

31211399U1	59,2x59,2x0,98 cm	RECT	P96
------------	-------------------	------	-----



29,5x59,2 · 59,2x59,2 · 59,2x118,6 · 44,35x88,9 · 88,9x88,9 cm	SOFT	V2	5	—	—	—	—	—	—	—
29,5x59,2 · 59,2x59,2 · 59,2x118,6 · 44,35x88,9 · 88,9x88,9 cm	POL	V3	3	—	—	—	—	—	—	U3P3E3C2
59,2x59,2 cm	MATT RECT	V2	5	class 2	A	R10	36+	≥0,42	U4P4+E3C2	—
29,5x59,2 · 59,2x118,6 · 44,35x88,9 · 88,9x88,9 cm	MATT RECT	V2	5	class 2	A	R10	36+	≥0,42	U4P3E3C2	—
59,2x59,2 cm	HEXAGON	MATT RECT	V2	5	class 2	A	R10	36+	≥0,42	—
59,2x59,2 cm	ESTR	RECT	V2	5	class 3	C	R12	40+	≥0,42	—

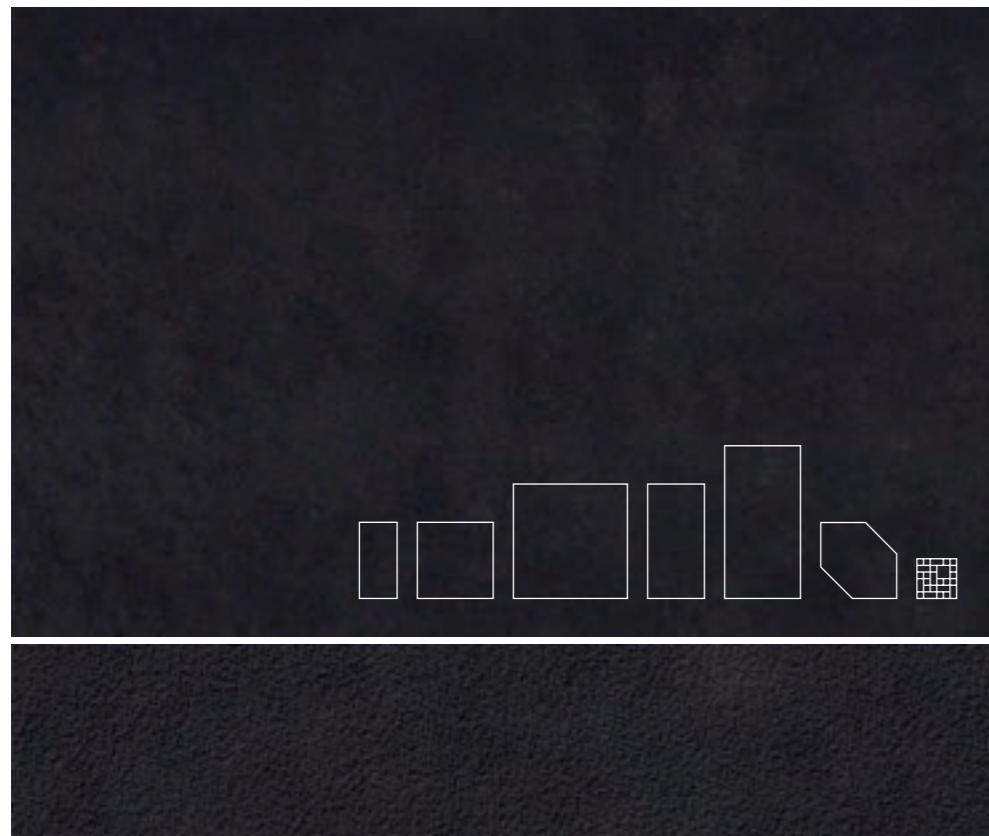

OMNI IRON

312B2184U1	29,5x59,2x0,98 cm	MATT RECT	P96
31262184U1	29,5x59,2x0,98 cm	SOFT	P96
31222184U1	29,5x59,2x0,93 cm	POL	P107
312B1384U1	59,2x59,2x0,98 cm	MATT RECT	P96
31261384U1	59,2x59,2x0,98 cm	SOFT	P96
31221384U1	59,2x59,2x0,93 cm	POL	P107
312BD384U1	59,2x118,6x0,98 cm	MATT RECT	P110
3126D384U1	59,2x118,6x0,98 cm	SOFT	P110
3122D384U1	59,2x118,6x0,93 cm	POL	P127
312BH884U1	44,35x88,9x1,05 cm	MATT RECT	P103
3126H884U1	44,35x88,9x1,05 cm	SOFT	P103
3122H884U1	44,35x88,9x0,98 cm	POL	P120
312BK784U1	88,9x88,9x1,05 cm	MATT RECT	P110
3126K784U1	88,9x88,9x1,05 cm	SOFT	P110
3122K784U1	88,9x88,9x0,98 cm	POL	P127

HEXAGON OMNI IRON (*)

332B13V271	59,2x59,2x0,98 cm	MATT RECT	P143
332613V271	59,2x59,2x0,98 cm	SOFT	P143

OMNI IRON ESTR

31211396U1	59,2x59,2x0,98 cm	RECT	P96
------------	-------------------	------	-----

OMNI JET

312B2185U1	29,5x59,2x0,98 cm	MATT RECT	P96
31262185U1	29,5x59,2x0,98 cm	SOFT	P96
31222185U1	29,5x59,2x0,93 cm	POL	P107
312B1385U1	59,2x59,2x0,98 cm	MATT RECT	P96
31261385U1	59,2x59,2x0,98 cm	SOFT	P96
31221385U1	59,2x59,2x0,93 cm	POL	P107
312BD385U1	59,2x118,6x0,98 cm	MATT RECT	P110
3126D385U1	59,2x118,6x0,98 cm	SOFT	P110
3122D385U1	59,2x118,6x0,93 cm	POL	P127
312BH885U1	44,35x88,9x1,05 cm	MATT RECT	P103
3126H885U1	44,35x88,9x1,05 cm	SOFT	P103
3122H885U1	44,35x88,9x0,98 cm	POL	P120
312BK785U1	88,9x88,9x1,05 cm	MATT RECT	P110
3126K785U1	88,9x88,9x1,05 cm	SOFT	P110
3122K785U1	88,9x88,9x0,98 cm	POL	P127

HEXAGON OMNI JET (*)

332B13V281	59,2x59,2x0,98 cm	MATT RECT	P143
332613V281	59,2x59,2x0,98 cm	SOFT	P143

OMNI JET ESTR

31211397U1	59,2x59,2x0,98 cm	RECT	P96
------------	-------------------	------	-----



OMNI IRON _ OMNI JET

Estruturado _ Structured: Produtos que minimizam o risco de deslizamento.
Estruturado _ Structured: Products that minimize the risk of slipping.
Estruturado _ Structured: Produits qui réduisent le risque de glissement.
Estruturado _ Structured: Productos que minimizan el riesgo de deslizamiento.

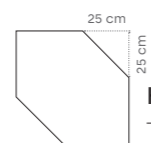

HEXAGON

[1m² = 3,4 peças_pieces]



MOLTI (a)(f)

29,5x29,5x0,98 cm MATT RECT P22 /peça_piece
 [1m² = 11 peças_pieces]

(*) Peças produzidas de acordo com quantidades mínimas de 10m².
 (*) Pieces produced in minimum quantities of 10m².
 (*) Pièces produites selon des quantités minimales de 10m².
 (*) Piezas producidas en cantidades mínimas de 10m².



29,5x59,2 · 59,2x59,2 · 59,2x118,6 · 44,35x88,9 · 88,9x88,9 cm	SOFT	V2	5	—	—	—	—	—	—
29,5x59,2 · 59,2x59,2 · 59,2x118,6 · 44,35x88,9 · 88,9x88,9 cm	POL	V3	3	—	—	—	—	—	U3P3E3C2
59,2x59,2 cm	MATT RECT	V2	5	class 2	A	R10	36+	≥0,42	U4P4+E3C2
29,5x59,2 · 59,2x118,6 · 44,35x88,9 · 88,9x88,9 cm	MATT RECT	V2	5	class 2	A	R10	36+	≥0,42	U4P3E3C2
59,2x59,2 cm HEXAGON	MATT RECT	V2	5	class 2	A	R10	36+	≥0,42	—
59,2x59,2 cm ESTR	RECT	V2	5	class 3	C	R12	40+	≥0,42	—



OMNI IRON _ OMNI JET



PEÇAS · PIECES			CAIXA · BOX			EUROPALETE · EUROPALLET		
		±	PZ	M²	KG	CX	M²	KG
29,5x59,2 cm	MATT RECT · SOFT	9,8 ±5%	8	1.40	33.0	32	44.80	1077
	POL	9,3 ±5%	8	1.40	31.0	32	44.80	1013
59,2x59,2 cm	MATT RECT · SOFT · ESTR	9,8 ±5%	4	1.40	33.0	32	44.80	1077
	MATT RECT · SOFT Hexagon	9,8 ±5%	4	1.19	27.4	32	38.08	897
59,2x118,6 cm	POL	9,3 ±5%	4	1.40	31.0	32	44.80	1013
	MATT RECT · SOFT	9,8 ±5%	2	1.40	33.0	30	42.00	1011
44,35x88,9 cm	POL	9,3 ±5%	2	1.40	31.0	30	42.00	951
	MATT RECT · SOFT	10,5 ±0,5mm	4	1.58	39.0	24	37.92	991
88,9x88,9 cm	POL	9,8 ±5%	4	1.58	37.0	24	37.92	943
	MATT RECT · SOFT	10,5 ±0,5 mm	2	1.58	39.0	24	37.92	991
88,9x88,9 cm	POL	9,8 ±5%	2	1.58	37.0	24	37.92	943

PEÇA · PIECE			PEÇA · PIECE			PEÇA · PIECE			PEÇA · PIECE			PEÇA · PIECE		
DG	MATT RECT ESTR RECT SOFT	POL	RB	MATT RECT ESTR RECT SOFT	POL	DG CF	MATT RECT ESTR RECT SOFT	POL	DG CF SS	MATT RECT ESTR RECT SOFT	POL	DG CF CANTO	MATT RECT ESTR RECT SOFT	POL
29,5x59,2 cm	P18	P18	9,5x29,5 cm	P08	P08	29,5x59,2 cm	P157	P157	29,5x59,2 cm	P157		29,5x59,2 cm	P207	P207
59,2x59,2 cm	P36	P36	8x44,35 cm	P16	P16									
44,35x88,9 cm	P96	P96	8x59,2 cm	P12	P12									
29,5x118,6 cm	P96	P96	8x88,9 cm	P28	P28									
59,2x118,6 cm	P167	P167	8x118,6 cm	P28	P28									

DG CF / DG CF Canto/DG CF SS: Peças produzidas sob encomenda. Altura do fochino: entre 3 cm e 10 cm. Indicar a altura pretendida no ato da encomenda.
 DG CF / DG CF Canto/DG CF SS: Pieces produced on order. Trim height: 3 to 10 cm. Specify desired height when placing a order.
 DG CF / DG CF Canto/DG CF SS: Pièces produites sur commande. Hauteur du nez de marche : entre 3 cm et 10 cm. Préciser la hauteur souhaitée lors de la commande.
 DG CF / DG CF Canto/DG CF SS: Piezas producidas por encargo. Altura del ángulo: entre 3 y 10 cm. Indicar la altura deseada al realizar el pedido.

DG CF Canto: Disponível em canto esquerdo e direito.
 DG CF Canto: Available in left and right corner.
 DG CF Canto: Disponible en angle gauche et droit.
 DG CF Canto: Canto izquierdo y derecho disponibles.

GRAPHIC VARIATION



LINEA 2	LINEA 4	LINEA 8
29,5x59,2	29,5x59,2	29,5x59,2

Pág. 44

De modo a proteger a superfície das peças, os produtos no acabamento polido têm uma fina camada de impermeabilizante, que apenas deve ser removida após a conclusão da obra.
 Tiles with polished finish are protected with waterproof coating that must be removed only after the works are concluded.
 En vue de protéger la surface des pièces, les produits à la finition polie ont une fine couche d'imperméabilisant qui ne devrait être enlevée qu'après l'achèvement des travaux.
 Con el fin de proteger la superficie de las piezas, los productos con acabado pulido tienen una fina capa de impermeabilizante, que solo debe eliminarse una vez terminado el trabajo.
 Os desenhos das peças intensificam-se no acabamento polido, aumentando a variação de desenhos e de cores, entre peças.
 The designs of the pieces are more intense in the polished finish, enhancing design and colour variation across pieces.
 Les dessins des pièces s'intensifient avec la finition polie, augmentant la variation des dessins et des couleurs entre les pièces.
 Los diseños de las piezas se intensifican con el acabado pulido, aumentando la variación de diseños y colores entre las piezas.



FULL-BODY

OMNISTONE



6 cores colours couleurs colores 5 formatos formats formats 2 acabamentos finishes finitions acabados

Qualidade técnica aliada a nuances gráficas inspiradas na sutileza da pedra natural.

Technical quality combined with graphic nuances inspired by the subtlety of natural stone.

Qualité technique alliée aux nuances graphiques inspirées de la subtilité de la pierre naturelle.

Calidad técnica conjugada con matices gráficos inspirados en la sutileza de la piedra natural.

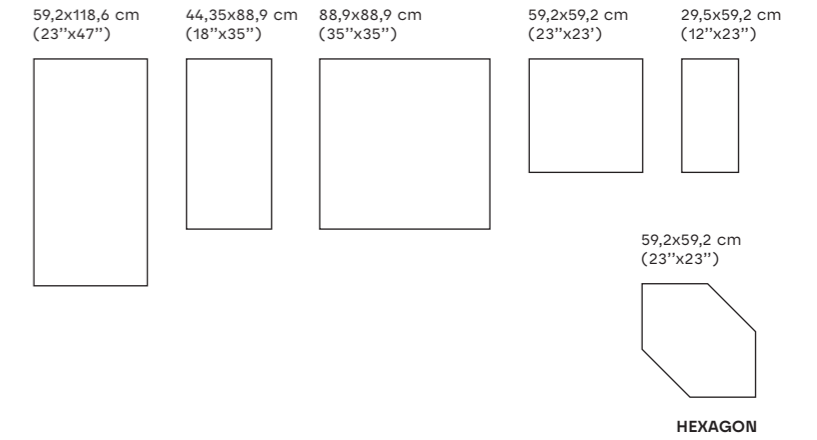

MATT RECT · SOFT

16
Até 16 desenhos
Up to 16 designs
Jusqu'à 16 dessins
Hasta 16 diseños

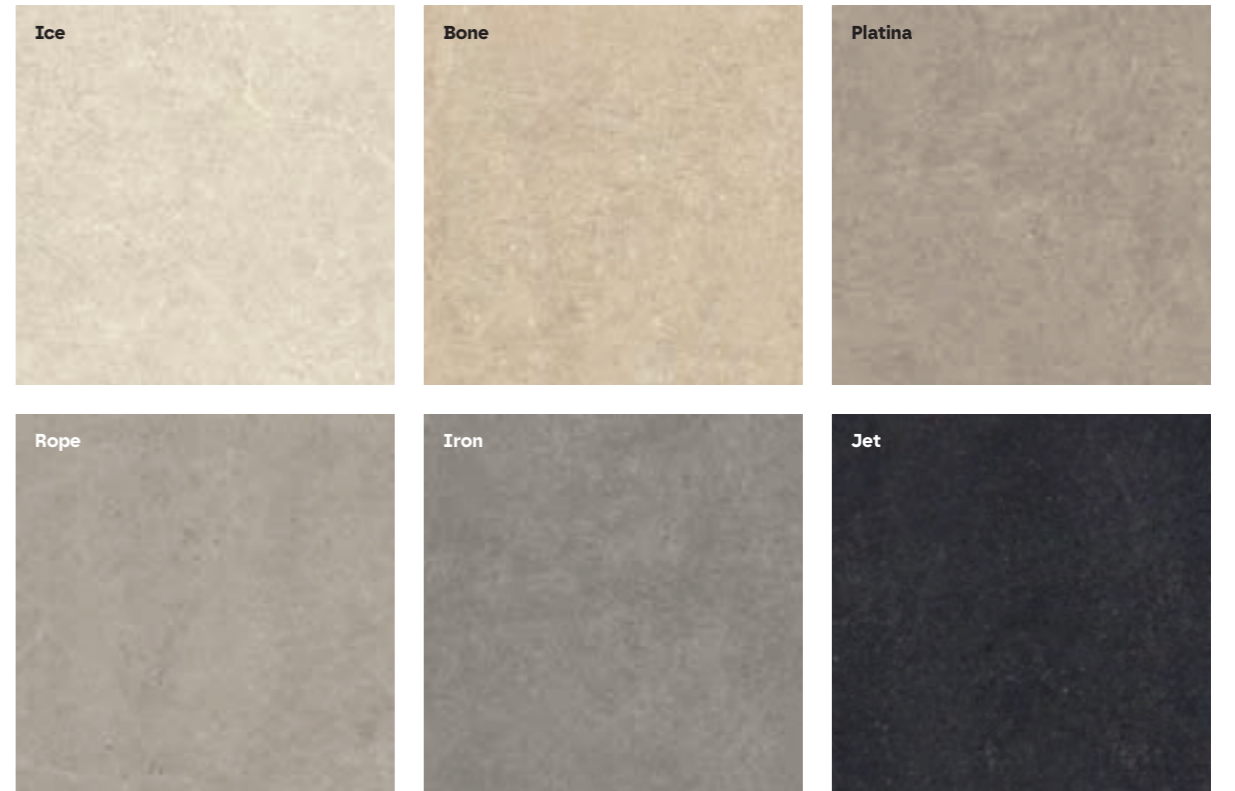

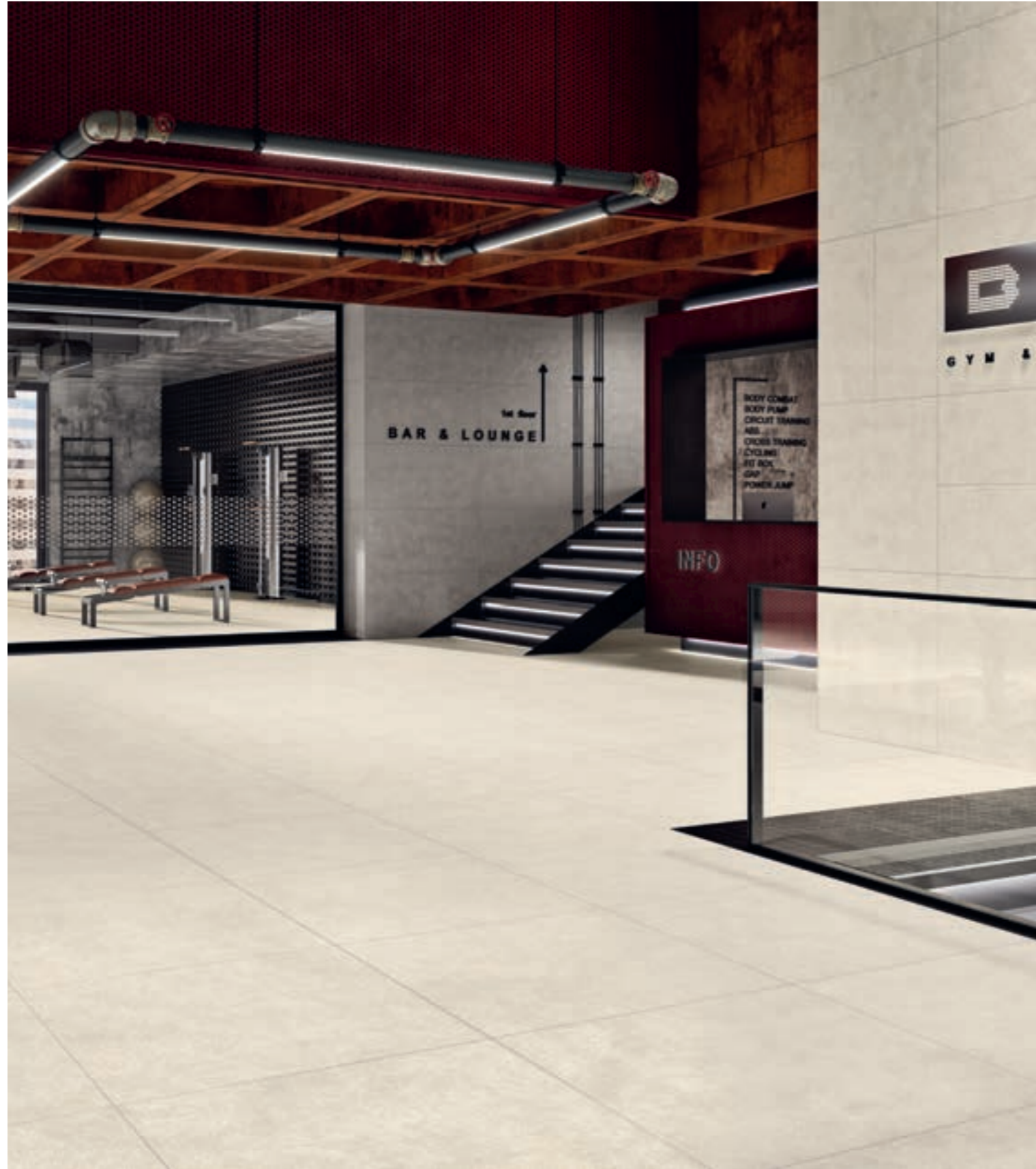

64 OMNISTONE ICE



65

OMNISTONE

FULL BODY



OMNISTONE ICE

312B2189U1	29,5x59,2x0,98 cm	MATT RECT	P110
31262189U1	29,5x59,2x0,98 cm	SOFT	P110
312B1389U1	59,2x59,2x0,98 cm	MATT RECT	P110
31261389U1	59,2x59,2x0,98 cm	SOFT	P110
312BD389U1	59,2x118,6x0,98 cm	MATT RECT	P123
3126D389U1	59,2x118,6x0,98 cm	SOFT	P123
312BH889U1	44,35x88,9x1,05 cm	MATT RECT	P116
3126H889U1	44,35x88,9x1,05 cm	SOFT	P116
312BK789U1	88,9x88,9x1,05 cm	MATT RECT	P123
3126K789U1	88,9x88,9x1,05 cm	SOFT	P123

HEXAGON OMNISTONE ICE (*)

332B13V201	59,2x59,2x0,98 cm	MATT RECT	P159
332613V201	59,2x59,2x0,98 cm	SOFT	P159

OMNISTONE BONE

312B2188U1	29,5x59,2x0,98 cm	MATT RECT	P105
31262188U1	29,5x59,2x0,98 cm	SOFT	P105
312B1388U1	59,2x59,2x0,98 cm	MATT RECT	P105
31261388U1	59,2x59,2x0,98 cm	SOFT	P105
312BD388U1	59,2x118,6x0,98 cm	MATT RECT	P120
3126D388U1	59,2x118,6x0,98 cm	SOFT	P120
312BH888U1	44,35x88,9x1,05 cm	MATT RECT	P114
3126H888U1	44,35x88,9x1,05 cm	SOFT	P114
312BK788U1	88,9x88,9x1,05 cm	MATT RECT	P120
3126K788U1	88,9x88,9x1,05 cm	SOFT	P120

HEXAGON OMNISTONE BONE (*)

332B13V191	59,2x59,2x0,98 cm	MATT RECT	P153
332613V191	59,2x59,2x0,98 cm	SOFT	P153

OMNISTONE PLATINA

312B2192U1	29,5x59,2x0,98 cm	MATT RECT	P102
31262192U1	29,5x59,2x0,98 cm	SOFT	P102
312B1392U1	59,2x59,2x0,98 cm	MATT RECT	P102
31261392U1	59,2x59,2x0,98 cm	SOFT	P102
312BD392U1	59,2x118,6x0,98 cm	MATT RECT	P114
3126D392U1	59,2x118,6x0,98 cm	SOFT	P114
312BH892U1	44,35x88,9x1,05 cm	MATT RECT	P106
3126H892U1	44,35x88,9x1,05 cm	SOFT	P106
312BK792U1	88,9x88,9x1,05 cm	MATT RECT	P114
3126K792U1	88,9x88,9x1,05 cm	SOFT	P114

HEXAGON OMNISTONE PLATINA (*)

332B13V231	59,2x59,2x0,98 cm	MATT RECT	P147
332613V231	59,2x59,2x0,98 cm	SOFT	P147



OMNISTONE

FULL BODY



OMNISTONE ROPE

312B2193U1	29,5x59,2x0,98 cm	MATT RECT	P102
31262193U1	29,5x59,2x0,98 cm	SOFT	P102
312B1393U1	59,2x59,2x0,98 cm	MATT RECT	P102
31261393U1	59,2x59,2x0,98 cm	SOFT	P102
312BD393U1	59,2x118,6x0,98 cm	MATT RECT	P114
3126D393U1	59,2x118,6x0,98 cm	SOFT	P114
312BH893U1	44,35x88,9x1,05 cm	MATT RECT	P106
3126H893U1	44,35x88,9x1,05 cm	SOFT	P106
312BK793U1	88,9x88,9x1,05 cm	MATT RECT	P114
3126K793U1	88,9x88,9x1,05 cm	SOFT	P114

HEXAGON OMNISTONE ROPE (*)

332B13V241	59,2x59,2x0,98 cm	MATT RECT	P147
332613V241	59,2x59,2x0,98 cm	SOFT	P147

OMNISTONE IRON

312B2190U1	29,5x59,2x0,98 cm	MATT RECT	P102
31262190U1	29,5x59,2x0,98 cm	SOFT	P102
312B1390U1	59,2x59,2x0,98 cm	MATT RECT	P102
31261390U1	59,2x59,2x0,98 cm	SOFT	P102
312BD390U1	59,2x118,6x0,98 cm	MATT RECT	P114
3126D390U1	59,2x118,6x0,98 cm	SOFT	P114
312BH890U1	44,35x88,9x1,05 cm	MATT RECT	P106
3126H890U1	44,35x88,9x1,05 cm	SOFT	P106
312BK790U1	88,9x88,9x1,05 cm	MATT RECT	P114
3126K790U1	88,9x88,9x1,05 cm	SOFT	P114

HEXAGON OMNISTONE IRON (*)

332B13V211	59,2x59,2x0,98 cm	MATT RECT	P147
332613V211	59,2x59,2x0,98 cm	SOFT	P147

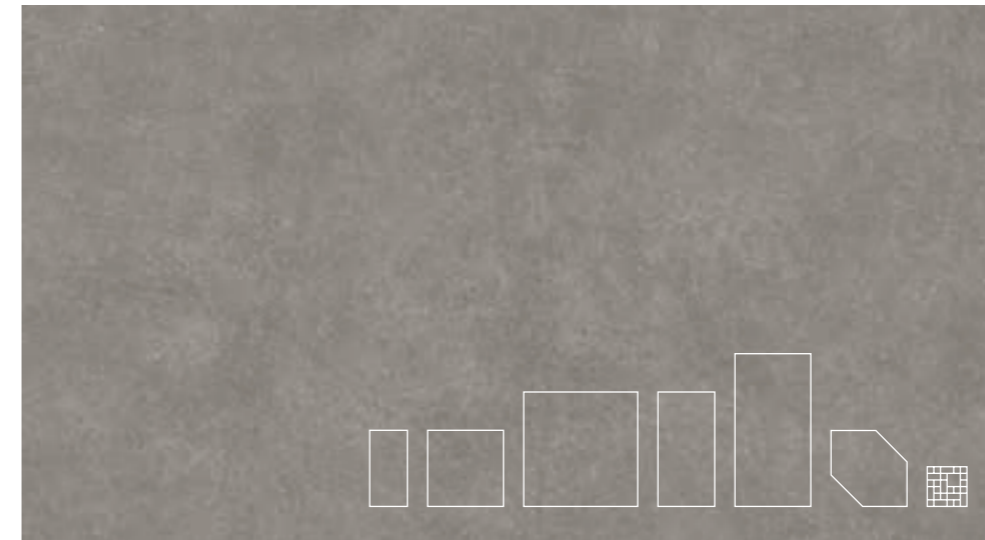

OMNISTONE JET

312B2191U1	29,5x59,2x0,98 cm	MATT RECT	P102
31262191U1	29,5x59,2x0,98 cm	SOFT	P102
312B1391U1	59,2x59,2x0,98 cm	MATT RECT	P102
31261391U1	59,2x59,2x0,98 cm	SOFT	P102
312BD391U1	59,2x118,6x0,98 cm	MATT RECT	P114
3126D391U1	59,2x118,6x0,98 cm	SOFT	P114
312BH891U1	44,35x88,9x1,05 cm	MATT RECT	P106
3126H891U1	44,35x88,9x1,05 cm	SOFT	P106
312BK791U1	88,9x88,9x1,05 cm	MATT RECT	P114
3126K791U1	88,9x88,9x1,05 cm	SOFT	P114

HEXAGON OMNISTONE JET (*)

332B13V221	59,2x59,2x0,98 cm	MATT RECT	P147
332613V221	59,2x59,2x0,98 cm	SOFT	P147

(*) Peças produzidas de acordo com quantidades mínimas de 10m².
 (*) Pieces produced in minimum quantities of 10m².
 (*) Pièces produites selon des quantités minimales de 10m².
 (*) Piezas producidas en cantidades mínimas de 10m².

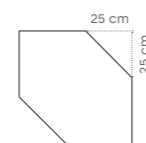

HEXAGON

[1m² = 3,4 peças_pieces]



MULTI (a)(f)

29,5x29,5x0,98 cm MATT RECT P22 /peça_piece
 [1m² = 11 peças_pieces]



29,5x59,2 · 59,2x59,2 · 59,2x118,6 · 44,35x88,9 · 88,9x88,9 cm	SOFT	V3	5	—	—	—	—	—	—
59,2x59,2 cm	MATT RECT	V3	5	class 2	B	R10	36+	≥0,42	U4P4+E3C2
29,5x59,2 · 59,2x118,6 · 44,35x88,9 · 88,9x88,9 cm	MATT RECT	V3	5	class 2	B	R10	36+	≥0,42	U4P3E3C2
59,2x59,2 cm HEXAGON	MATT RECT	V3	5	class 2	B	R10	36+	≥0,42	—



PEÇAS · PIECES			CAIXA · BOX			EUROPALETE · EUROPALLET		
		±	PZ	M ²	KG	CX	M ²	KG
29,5x59,2 cm	MATT RECT · SOFT	9,8 ±5%	8	1.40	33.0	32	44.80	1 077
59,2x59,2 cm	MATT RECT · SOFT	9,8 ±5%	4	1.40	33.0	32	44.80	1 077
	MATT RECT · SOFT Hexagon	9,8 ±5%	4	1.19	27.4	32	38.08	897
59,2x118,6 cm	MATT RECT · SOFT	9,8 ±5%	2	1.40	33.0	30	42.00	1 011
44,35x88,9 cm	MATT RECT · SOFT	10,5 ±0,5mm	4	1.58	39.0	24	37.92	991
88,9x88,9 cm	MATT RECT · SOFT	10,5 ±0,5 mm	2	1.58	39.0	24	37.92	991

PEÇA · PIECE		PEÇA · PIECE		PEÇA · PIECE		PEÇA · PIECE		PEÇA · PIECE	
DG	MATT RECT SOFT	RB	MATT RECT SOFT	DG CF	MATT RECT SOFT	DG CF SS	MATT RECT SOFT	DG CF CANTO	MATT RECT SOFT
29,5x59,2 cm	P18	9,5x29,5 cm	P08	29,5x59,2 cm	P157	29,5x59,2 cm	P157	29,5x59,2 cm	P207
59,2x59,2 cm	P36	8x44,35 cm	P16						
44,35x88,9 cm	P96	8x59,2 cm	P12						
29,5x118,6 cm	P96	8x88,9 cm	P28						
59,2x118,6 cm	P167	8x118,6 cm	P28						

DG CF / DG CF Canto/DG CF SS: Peças produzidas sob encomenda. Altura do flocinho: entre 3 cm e 10 cm. Indicar a altura pretendida no ato da encomenda.
 DG CF / DG CF Canto/DG CF SS: Pieces produced on order. Trim height: 3 to 10 cm. Specify desired height when placing a order.
 DG CF / DG CF Canto/DG CF SS: Pièces produites sur commande. Hauteur du nez de marche : entre 3 cm et 10 cm. Préciser la hauteur souhaitée lors de la commande.
 DG CF / DG CF Canto/DG CF SS: Piezas producidas por encargo. Altura del ángulo: entre 3 y 10 cm. Indicar la altura deseada al realizar el pedido.

DG CF Canto: Disponível em canto esquerdo e direito.
 DG CF Canto: Available in left and right corner.
 DG CF Canto: Disponible en angle gauche et droit.
 DG CF Canto: Canto izquierdo y derecho disponibles.

GRAPHIC VARIATION

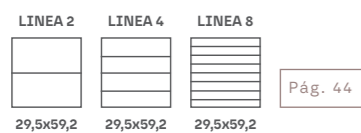



FULL-BODY

FLINT

8 cores / colours / couleurs / colores
 5 formatos / formats / formats / formatos
 4 acabamentos / finishes / finitions / acabados



A versatilidade e elevada durabilidade do grés porcelânico toda a massa.

The versatility and high durability of full-body porcelain tiles.

La versatilité et la haute durabilité du grés cérame pleine masse.

La versatilidad y elevada durabilidad del gres porcelánico todo masa.

59,2x118,6 cm (23"x47")
 88,9x88,9 cm (35"x35")
 59,2x59,2 cm (23"x23")
 29,5x59,2 cm (12"x23")
 29,5x59,2 cm (12"x12")

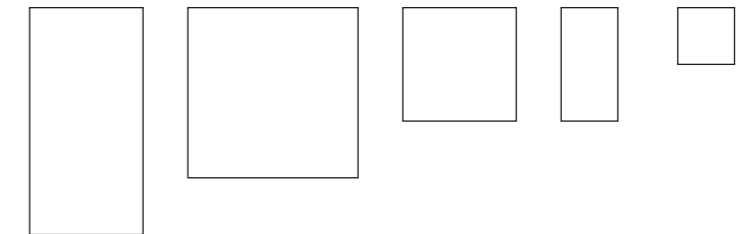

RECT · SOFT · POL · ESTR



FLINT

FULL BODY

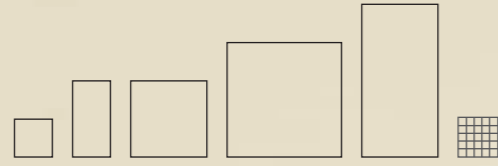

FLINT MARFIM

3121126421	29,5x29,5x0,85 cm	RECT	P94
3126126421	29,5x29,5x0,85 cm	SOFT	P94
3122126421	29,5x29,5x0,80 cm	POL	P110
3121216421	29,5x59,2x0,85 cm	RECT	P91
3126215Y31	29,5x59,2x0,85 cm	SOFT	P91
3122216421	29,5x59,2x0,80 cm	POL	P105
3121136421	59,2x59,2x0,85 cm	RECT	P102
3126135Y31	59,2x59,2x0,85 cm	SOFT	P102
3122136421	59,2x59,2x0,80 cm	POL	P112
3121D36421	59,2x118,6x0,98 cm	RECT	P120
3126D35Y31	59,2x118,6x0,98 cm	SOFT	P120
3122D36421	59,2x118,6x0,93 cm	POL	P137
3121K76421	88,9x88,9x1,05 cm	RECT	P120
3126K76421	88,9x88,9x1,05 cm	SOFT	P120
3122K76421	88,9x88,9x0,98 cm	POL	P137

FLINT MARFIM ESTR

3121215R31	29,5x59,2x0,85 cm	RECT	P91
3121135R31	59,2x59,2x0,85 cm	RECT	P102

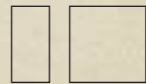

FLINT PLATINA

3121126431	29,5x29,5x0,85 cm	RECT	P89
3126126431	29,5x29,5x0,85 cm	SOFT	P89
3122126431	29,5x29,5x0,80 cm	POL	P101
3121216431	29,5x59,2x0,85 cm	RECT	P85
3126216431	29,5x59,2x0,85 cm	SOFT	P85
3122216431	29,5x59,2x0,80 cm	POL	P98
3121136431	59,2x59,2x0,85 cm	RECT	P94
3126136431	59,2x59,2x0,85 cm	SOFT	P94
3122136431	59,2x59,2x0,80 cm	POL	P110
3121D36431	59,2x118,6x0,98 cm	RECT	P114
3126D36431	59,2x118,6x0,98 cm	SOFT	P114
3122D36431	59,2x118,6x0,93 cm	POL	P130
3121K76431	88,9x88,9x1,05 cm	RECT	P114
3126K76431	88,9x88,9x1,05 cm	SOFT	P114
3122K76431	88,9x88,9x0,98 cm	POL	P130

FLINT PLATINA ESTR

3121217301	29,5x59,2x0,85 cm	RECT	P85
3121137301	59,2x59,2x0,85 cm	RECT	P94

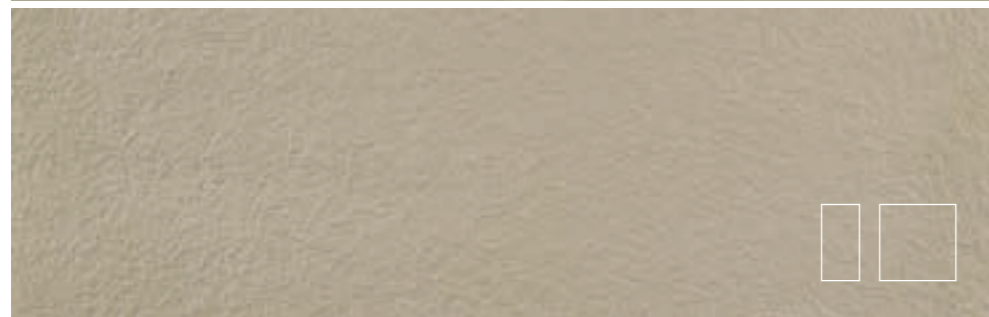
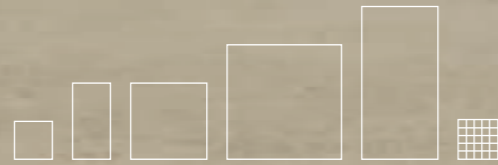
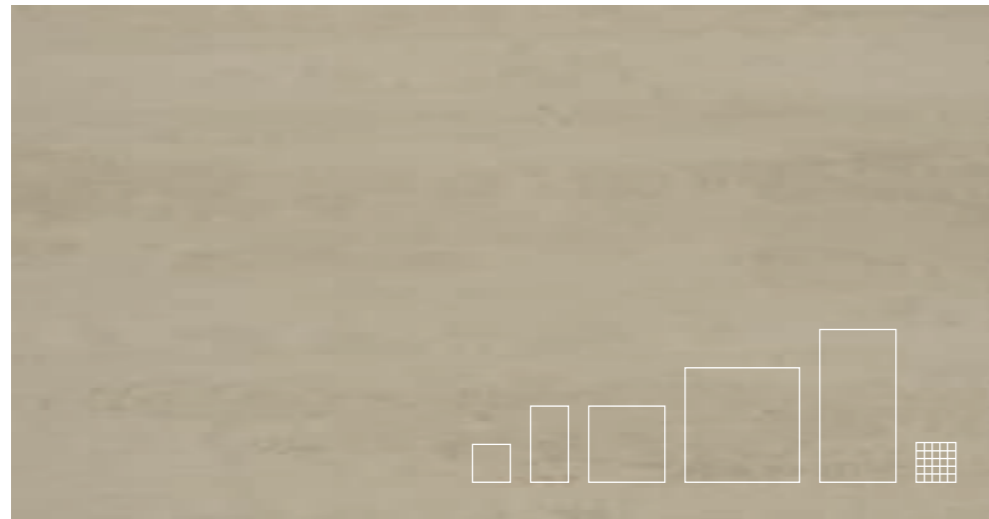

STRATUS 36 (a)(f)

29,5x29,5x0,85 cm	RECT	P19 /peça_piece
[1m ² = 11 peças_pieces]		

Estruturado _ Structured: Produtos que minimizam o risco de deslizamento.
Estruturado _ Structured: Products that minimize the risk of slipping.
Estruturado _ Structured: Produits qui réduisent le risque de glissement.
Estruturado _ Structured: Productos que minimizan el riesgo de deslizamiento.

FLINT

FULL BODY

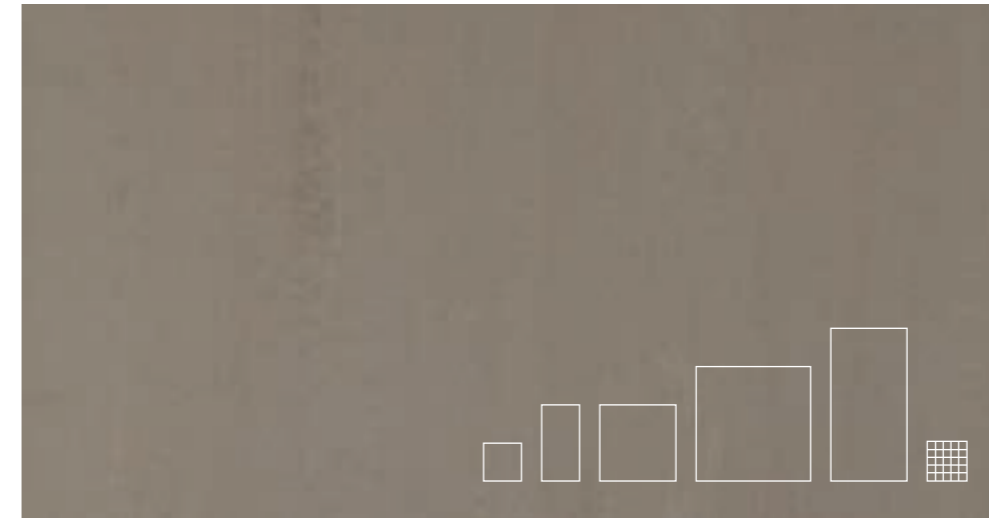

FLINT ARG PRATA

3121126441	29,5x29,5x0,85 cm	RECT	P89
3126126441	29,5x29,5x0,85 cm	SOFT	P89
3122126441	29,5x29,5x0,80 cm	POL	P101
3121216441	29,5x59,2x0,85 cm	RECT	P85
3126216441	29,5x59,2x0,85 cm	SOFT	P85
3122216441	29,5x59,2x0,80 cm	POL	P98
3121136441	59,2x59,2x0,85 cm	RECT	P94
3126136441	59,2x59,2x0,85 cm	SOFT	P94
3122136441	59,2x59,2x0,80 cm	POL	P110
3121D3W441	59,2x118,6x0,98 cm	RECT	P114
3126D36441	59,2x118,6x0,98 cm	SOFT	P114
3122D36441	59,2x118,6x0,93 cm	POL	P130
3121K76441	88,9x88,9x1,05 cm	RECT	P114
3126K76441	88,9x88,9x1,05 cm	SOFT	P114
3122K76441	88,9x88,9x0,98 cm	POL	P130

FLINT ARG PRATA ESTR

3121215R01	29,5x59,2x0,85 cm	RECT	P85
3121135R01	59,2x59,2x0,85 cm	RECT	P94



FLINT ICE

312112S881	29,5x29,5x0,85 cm	RECT	P98
312612S881	29,5x29,5x0,85 cm	SOFT	P98
312212S881	29,5x29,5x0,80 cm	POL	P114
312121S881	29,5x59,2x0,85 cm	RECT	P94
312621S881	29,5x59,2x0,85 cm	SOFT	P94
312221S881	29,5x59,2x0,80 cm	POL	P110
312113S881	59,2x59,2x0,85 cm	RECT	P105
312613S881	59,2x59,2x0,85 cm	SOFT	P105
312213S881	59,2x59,2x0,80 cm	POL	P119
3121D3S881	59,2x118,6x0,98 cm	RECT	P123
3126D3S881	59,2x118,6x0,98 cm	SOFT	P123
3122D3S881	59,2x118,6x0,93 cm	POL	P140
3121K7S881	88,9x88,9x1,05 cm	RECT	P123
3126K7S881	88,9x88,9x1,05 cm	SOFT	P123
3122K7S881	88,9x88,9x0,98 cm	POL	P140

FLINT ICE ESTR

312121T051	29,5x59,2x0,85 cm	RECT	P94
312113T051	59,2x59,2x0,85 cm	RECT	P105

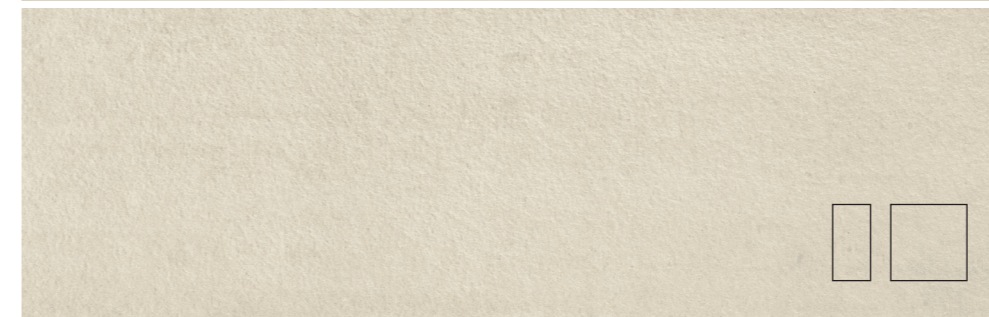

29,5x59,2 · 59,2x59,2 · 59,2x118,6 · 44,35x88,9 · 88,9x88,9 cm	SOFT	V2	5	—	—	—	—	—	—	
29,5x59,2 · 59,2x59,2 · 59,2x118,6 · 44,35x88,9 · 88,9x88,9 cm	POL	V3	3	—	—	—	—	—	U3P3E3C2	
29,5x29,5 · 59,2x59,2 cm	RECT · MATT RECT	V2	5	class 2	A	R10	36+	≥0,42	U4P4E3C2	
29,5x59,2 · 59,2x118,6 · 88,9x88,9 cm	RECT · MATT RECT	V2	5	class 2	A	R10	36+	≥0,42	U4P3E3C2	
29,5x59,2 cm	ESTR	RECT	V2	5	class 3	B	R11	36+	≥0,42	U4P3E3C2
59,2x59,2 cm	ESTR	RECT	V2	5	class 3	B	R11	40+	≥0,42	U4P4E3C2

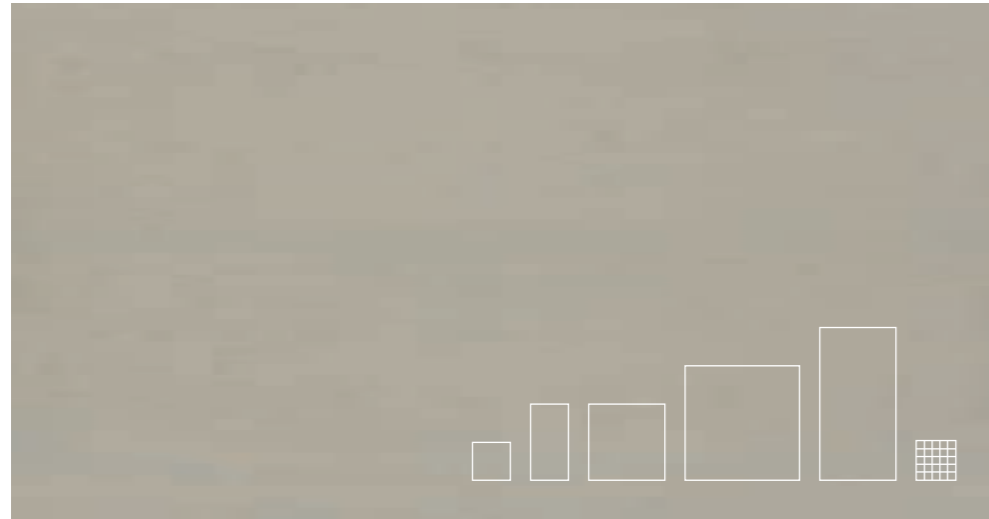
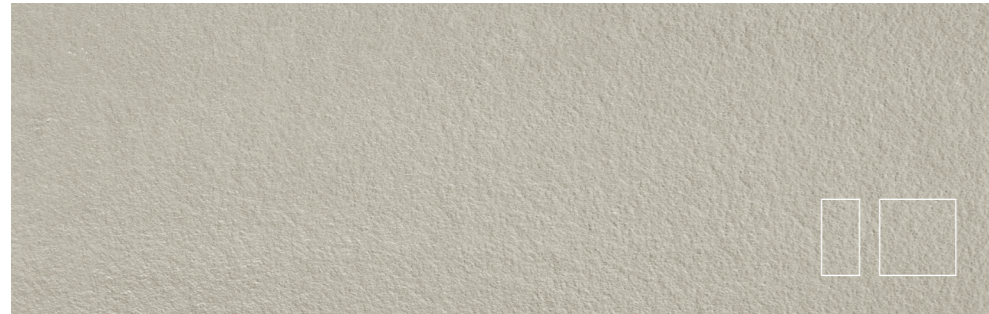

FLINT GLACIAR

312112S871	29,5x29,5x0,85 cm	RECT	P98
312612S871	29,5x29,5x0,85 cm	SOFT	P98
312212S871	29,5x29,5x0,80 cm	POL	P114
312121S871	29,5x59,2x0,85 cm	MATT RECT	P94
312621S871	29,5x59,2x0,85 cm	SOFT	P94
312221S871	29,5x59,2x0,80 cm	POL	P110
312113S871	59,2x59,2x0,85 cm	MATT RECT	P105
312613S871	59,2x59,2x0,85 cm	SOFT	P105
312213S871	59,2x59,2x0,80 cm	POL	P119
3121D3S871	59,2x118,6x0,98 cm	MATT RECT	P123
3126D3S871	59,2x118,6x0,98 cm	SOFT	P123
3122D3S871	59,2x118,6x0,93 cm	POL	P140
3121K7S871	88,9x88,9x1,05 cm	MATT RECT	P123
3126K7S871	88,9x88,9x1,05 cm	SOFT	P123
3122K7S871	88,9x88,9x0,98 cm	POL	P140

FLINT GLACIAR ESTR

312121T041	29,5x59,2x0,85 cm	RECT	P94
312113T041	59,2x59,2x0,85 cm	RECT	P105

FLINT FOG

312112R831	29,5x29,5x0,85 cm	RECT	P89
312612R831	29,5x29,5x0,85 cm	SOFT	P89
312212R831	29,5x29,5x0,80 cm	POL	P101
312121R831	29,5x59,2x0,85 cm	MATT RECT	P85
312621R831	29,5x59,2x0,85 cm	SOFT	P85
312221R831	29,5x59,2x0,80 cm	POL	P98
312113R831	59,2x59,2x0,85 cm	MATT RECT	P94
312613R831	59,2x59,2x0,85 cm	SOFT	P94
312213R831	59,2x59,2x0,80 cm	POL	P110
3121D3R831	59,2x118,6x0,98 cm	MATT RECT	P114
3126D3R831	59,2x118,6x0,98 cm	SOFT	P114
3122D3R831	59,2x118,6x0,93 cm	POL	P130
3121K7R831	88,9x88,9x1,05 cm	MATT RECT	P114
3126K7R831	88,9x88,9x1,05 cm	SOFT	P114
3122K7R831	88,9x88,9x0,98 cm	POL	P130

FLINT FOG ESTR

3121215R11	29,5x59,2x0,85 cm	RECT	P85
3121135R11	59,2x59,2x0,85 cm	RECT	P94



STRATUS 36 (a)(f)

29,5x29,5x0,85 cm	RECT	P19 /peça_pieza
[1m² = 11 peças_piezas]		

Estruturado _ Structured: Produtos que minimizam o risco de deslizamento.
 Estruturado _ Structured: Products that minimize the risk of slipping.
 Estruturado _ Structured: Produits qui réduisent le risque de glissement.
 Estruturado _ Structured: Productos que minimizan el riesgo de deslizamiento.

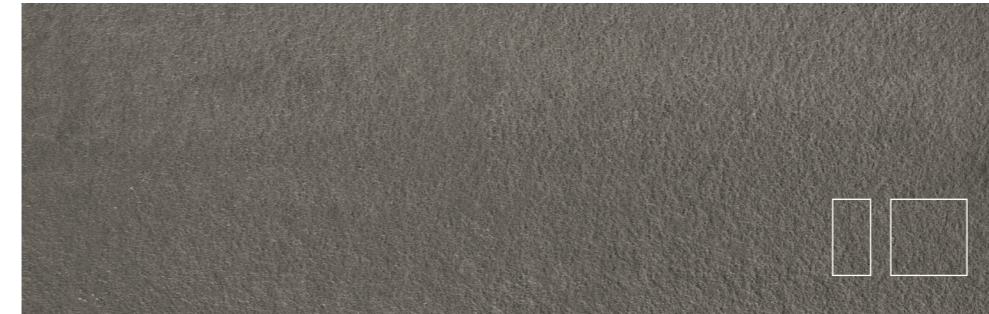

FLINT GRIS

312112R841	29,5x29,5x0,85 cm	RECT	P89
312612R841	29,5x29,5x0,85 cm	SOFT	P89
312212R841	29,5x29,5x0,80 cm	POL	P101
312121R841	29,5x59,2x0,85 cm	MATT RECT	P85
312621R841	29,5x59,2x0,85 cm	SOFT	P85
312221R841	29,5x59,2x0,80 cm	POL	P98
312113R841	59,2x59,2x0,85 cm	MATT RECT	P94
312613R841	59,2x59,2x0,85 cm	SOFT	P94
312213R841	59,2x59,2x0,80 cm	POL	P110
3121D3R841	59,2x118,6x0,98 cm	MATT RECT	P114
3126D3R841	59,2x118,6x0,98 cm	SOFT	P114
3122D3R841	59,2x118,6x0,93 cm	POL	P130
3121K7R841	88,9x88,9x1,05 cm	MATT RECT	P114
3126K7R841	88,9x88,9x1,05 cm	SOFT	P114
3122K7R841	88,9x88,9x0,98 cm	POL	P130

FLINT GRIS ESTR

3121216R31	29,5x59,2x0,85 cm	RECT	P85
3121136R31	59,2x59,2x0,85 cm	RECT	P94

FLINT PRETO

312112R761	29,5x29,5x0,85 cm	RECT	P89
312612R761	29,5x29,5x0,85 cm	SOFT	P89
312212R761	29,5x29,5x0,80 cm	POL	P101
312121R761	29,5x59,2x0,85 cm	MATT RECT	P85
312621R761	29,5x59,2x0,85 cm	SOFT	P85
312221R761	29,5x59,2x0,80 cm	POL	P98
312113R761	59,2x59,2x0,85 cm	MATT RECT	P94
312613R761	59,2x59,2x0,85 cm	SOFT	P94
312213R761	59,2x59,2x0,80 cm	POL	P110
3121D3R761	59,2x118,6x0,98 cm	MATT RECT	P114
3126D3R761	59,2x118,6x0,98 cm	SOFT	P114
3122D3R761	59,2x118,6x0,93 cm	POL	P130
3121K7R761	88,9x88,9x1,05 cm	MATT RECT	P114
3126K7R761	88,9x88,9x1,05 cm	SOFT	P114
3122K7R761	88,9x88,9x0,98 cm	POL	P130

FLINT PRETO ESTR

3121215R41	29,5x59,2x0,85 cm	RECT	P85
3121135R41	59,2x59,2x0,85 cm	RECT	P94

29,5x59,2 · 59,2x59,2 · 59,2x118,6 · 44,35x88,9 · 88,9x88,9 cm	SOFT	V2	5	—	—	—	—	—	—
29,5x59,2 · 59,2x59,2 · 59,2x118,6 · 44,35x88,9 · 88,9x88,9 cm	POL	V3	3	—	—	—	—	—	U3P3E3C2
29,5x29,5 · 59,2x59,2 cm	RECT · MATT RECT	V2	5	class 2	A	R10	36+	≥0,42	U4P4E3C2
29,5x59,2 · 59,2x118,6 · 88,9x88,9 cm	RECT · MATT RECT	V2	5	class 2	A	R10	36+	≥0,42	U4P3E3C2
29,5x59,2 cm ESTR	RECT	V2	5	class 3	B	R11	36+	≥0,42	U4P3E3C2
59,2x59,2 cm ESTR	RECT	V2	5	class 3	B	R11	40+	≥0,42	U4P4E3C2





FLINT ARG PRATA _ FLINT MARFIM

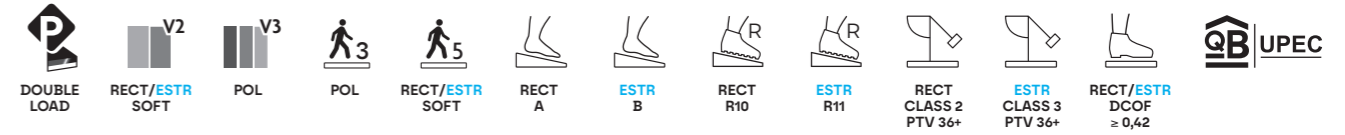

PEÇAS · PIECES			CAIXA · BOX			EUROPALETE · EUROPALLET		
		±	PZ	M ²	KG	CX	M ²	KG
29,5x29,5 cm	RECT · MATT RECT · SOFT	8,5 ±5%	16	1.39	28.8	40	55.60	1173
	POL	8,0 ±5%	16	1.39	25.6	40	55.60	1045
29,5x59,2 cm	RECT · MATT RECT · SOFT · ESTR	8,5 ±5%	8	1.40	28.8	32	44.80	943
	POL	8,0 ±5%	8	1.40	25.6	40	56.00	1045
59,2x59,2 cm	RECT · MATT RECT · SOFT · ESTR	8,5 ±5%	4	1.40	28.7	36	50.40	1053
	POL	8,0 ±5%	4	1.40	26.7	36	50.40	981
59,2x118,6 cm	RECT · MATT RECT · SOFT	9,8 ±5%	2	1.40	33.0	30	42.00	1011
	POL	9,3 ±5%	2	1.40	31.0	30	42.00	951
88,9x88,9 cm	RECT · MATT RECT · SOFT	10,5 ±0,5 mm	2	1.58	39.0	24	37.92	991
	POL	9,8 ±5%	2	1.58	37.0	24	37.92	943

DG	RECT RECT ESTR SOFT	POL	RB	RECT RECT ESTR SOFT	POL	BR	RECT RECT ESTR SOFT	POL	TC	RECT RECT ESTR SOFT	POL
29,5x29,5 cm	P10	P10	9,5x29,5 cm	P08	P08	7x29,5 cm	P06	P06	7x7 cm	P01	P02
29,5x59,2 cm	P18	P18	8x59,2 cm	P12	P12	7x59,2 cm	P09	P09			
59,2x59,2 cm	P36	P36	8x88,9 cm	P28	P28						
44,35x88,9 cm	P96	P96	8x118,6 cm	P28	P28						
29,5x118,6 cm	P96	P96									
59,2x118,6 cm	P167	P167									

DG CF	MATT RECT SOFT	POL	DG CF SS	MATT RECT SOFT	POL	DG CF CANTO	MATT RECT SOFT	POL
29,5x59,2 cm	P157	P157	29,5x59,2 cm	P157	P157	29,5x59,2 cm	P207	P207

DG CF / DG CF Canto/DG CF SS: Peças produzidas sob encomenda. Altura do flocinho: entre 3 cm e 10 cm. Indicar a altura pretendida no ato da encomenda.

DG CF / DG CF Canto/DG CF SS: Pieces produced on order. Trim height: 3 to 10 cm. Specify desired height when placing a order.

DG CF / DG CF Canto/DG CF SS: Pièces produites sur commande. Hauteur du nez de marche : entre 3 cm et 10 cm. Préciser la hauteur souhaitée lors de la commande.

DG CF / DG CF Canto/DG CF SS: Piezas producidas por encargo. Altura del ángulo: entre 3 y 10 cm. Indicar la altura deseada al realizar el pedido.

DG CF Canto: Disponível em canto esquerdo e direito.
DG CF Canto: Available in left and right corner.
DG CF Canto: Disponible en angle gauche et droit.
DG CF Canto: Canto izquierdo y derecho disponibles.

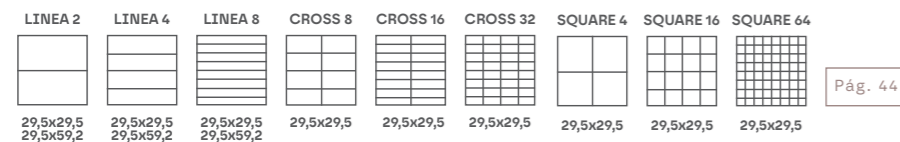

De modo a proteger a superfície das peças, os produtos no acabamento polido têm uma fina camada de impermeabilizante, que apenas deve ser removida após a conclusão da obra.
Tiles with polished finish are protected with waterproof coating that must be removed only after the works are concluded.
En vue de protéger la surface des pièces, les produits à la finition polie ont une fine couche d'imperméabilisant qui ne devrait être enlevée qu'après l'achèvement des travaux.
Con el fin de proteger la superficie de las piezas, los productos con acabado pulido tienen una fina capa de impermeabilizante, que solo debe eliminarse una vez terminado el trabajo.

Os desenhos das peças intensificam-se no acabamento polido, aumentando a variação de desenhos e de cores, entre peças.
The designs of the pieces are more intense in the polished finish, enhancing design and colour variation across pieces.
Les dessins des pièces s'intensifient avec la finition polie, augmentant la variation des dessins et des couleurs entre les pièces.
Los diseños de las piezas se intensifican con el acabado pulido, aumentando la variación de diseños y colores entre las piezas.

GRAPHIC VARIATION

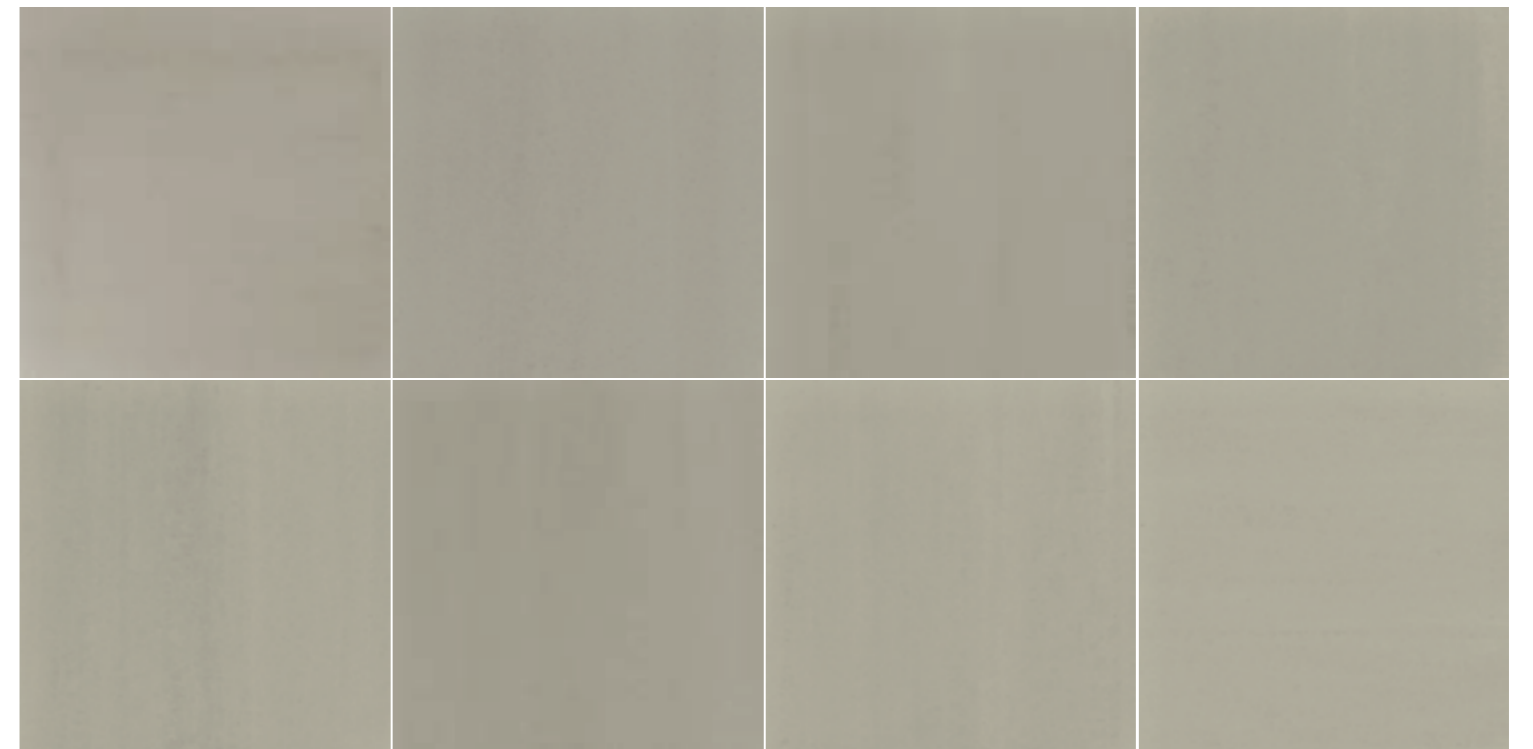



PIGMENTO GRAFITE

COLÉGIO "ORIENTE" — LISBOA, PORTUGAL
"ORIENTE" COLLEGE — LISBON, PORTUGAL

FULL-BODY

PIGMENTO

4 cores
colours
couleurs
colores

1 formato
format
formato

2 acabamentos
finishes
finitions
acabados



Soluções com elevada qualidade técnica e resistência para espaços públicos com tráfego elevado.

High technical quality and resistance solutions for heavy-duty public spaces.

Des solutions à la qualité technique élevée et qui présente une haute résistance pour les espaces publics au trafic intense.

Soluciones con gran calidad técnica y resistencia para espacios públicos con mucho tráfico.

30x30 cm
(12"x12")

NAT · ANTISLIP NAT

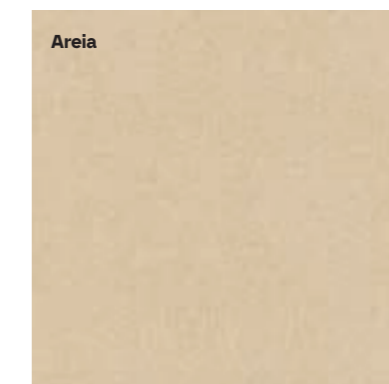

Areia



Luna

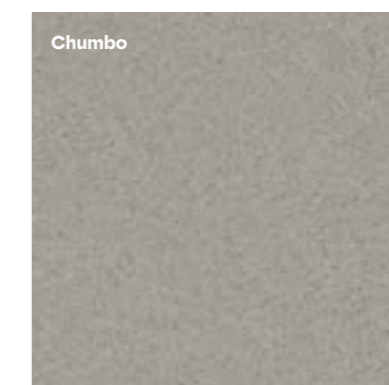

Chumbo



Grafite

PIGMENTO _ PIGMENTO ANTISLIP

FULL BODY



PIGMENTO AREIA

3521120431	30x30x0,70 cm	NAT	P60
312C127491	30x30x0,70 cm	ANTISLIP NAT	P63



PIGMENTO LUNA

3521120421	30x30x0,70 cm	NAT	P60
312C12R461	30x30x0,70 cm	ANTISLIP NAT	P63

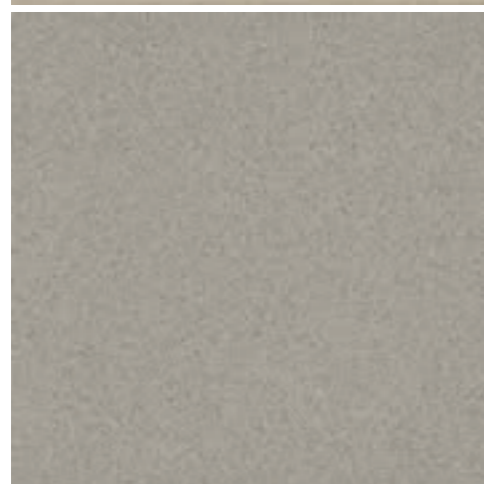

PIGMENTO CHUMBO

3521120411	30x30x0,70 cm	NAT	P60
312C127501	30x30x0,70 cm	ANTISLIP NAT	P63



PIGMENTO GRAFITE

312012R261	30x30x0,70 cm	NAT	P63
312C12R271	30x30x0,70 cm	ANTISLIP NAT	P66

Antislip: Produtos que minimizam o risco de deslizamento.
 Antislip: Products that minimize the risk of slipping.
 Antislip: Produits qui réduisent le risque de glissement.
 Antislip: Productos que minimizan el riesgo de deslizamiento.



30x30 cm	NAT	V2	5	class 1	A	R9	-	≥0,42	U4P3E3C2
30x30 cm	ANTISLIP NAT	V2	5	class 3	B	R11	36+	≥0,42	U4P3E3C2

PIGMENTO _ PIGMENTO ANTISLIP

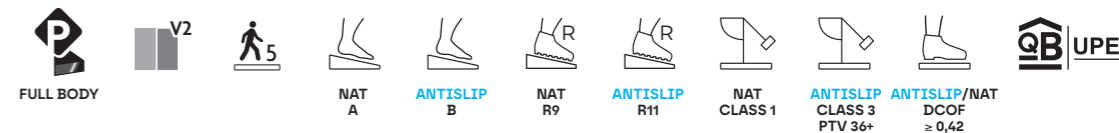

PEÇAS · PIECES	CAIXA · BOX			EUROPALETE · EUROPALLET		
	PZ	M²	KG	CX	M²	KG
30x30 cm NAT · ANTISLIP NAT 7,0 ±5%	16	1,44	24,0	40	57,60	981

DG	NAT	RB	NAT
30x30 cm	ANTISLIP NAT	9,5x30 cm	ANTISLIP NAT
P07		P04	



PIGMENTO GRAFITE

COLÉGIO "ORIENTE" — LISBOA, PORTUGAL
 "ORIENTE" COLLEGE — LISBON, PORTUGAL

FULL BODY

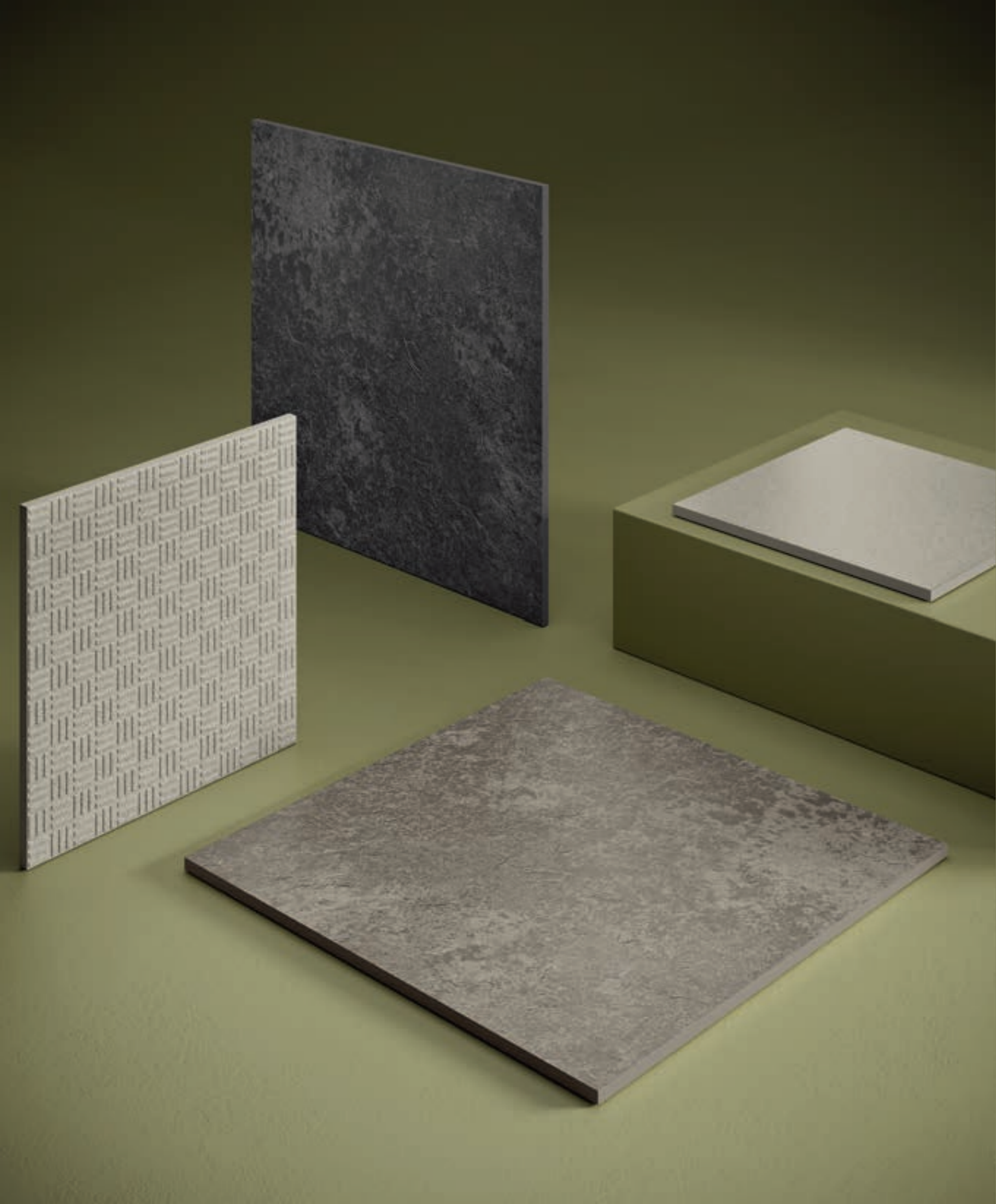

ECOTILES

Ecotech	084
Saturno	088



ECOTILES

ECOTECH



2 cores
colours
couleurs
colores

1 formato
format
format
formato

1 acabamento
finish
finition
acabado

Proteger o ambiente passa por escolher produtos com materiais reciclados.

Selecting products made from recycled materials is essential for protecting the environment.

Protéger l'environnement passe par le choix des produits fabriqués à partir de matériaux recyclés.

Proteger el medioambiente pasa por elegir productos con materiales reciclados.

45x45 cm
(18"x18")



NAT

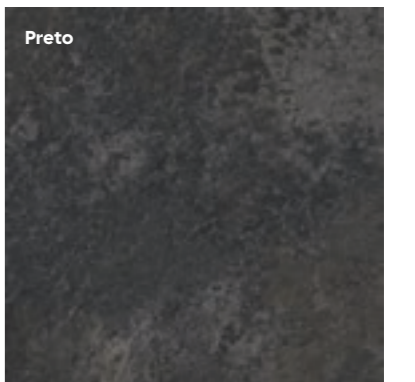



ECOTECH CINZA

312007R821 45x45x0,82 cm NAT P64



ECOTECH PRETO

31200744R1 45x45x0,82 cm NAT P64



ECO TILES

PRODUTO QUE INTEGRA MATERIAIS RECICLADOS
 PRODUCT THAT INCORPORATES RECYCLED MATERIALS
 PRODUIT INTEGRANT DES MATÉRIAUX RECYCLÉS
 PRODUCTO QUE INCORPORA MATERIALES RECICLADOS

PEÇAS · PIECES			CAIXA · BOX			EUROPALETE · EUROPALLET		
		±	PZ	M²	KG	CX	M²	KG
45x45 cm	NAT	8,2 ±5%	6	1,22	24,0	34	41,48	837

PEÇA · PIECE		PEÇA · PIECE	
DG	NAT	RB	NAT
45x45 cm	P10	8x45 cm	P07

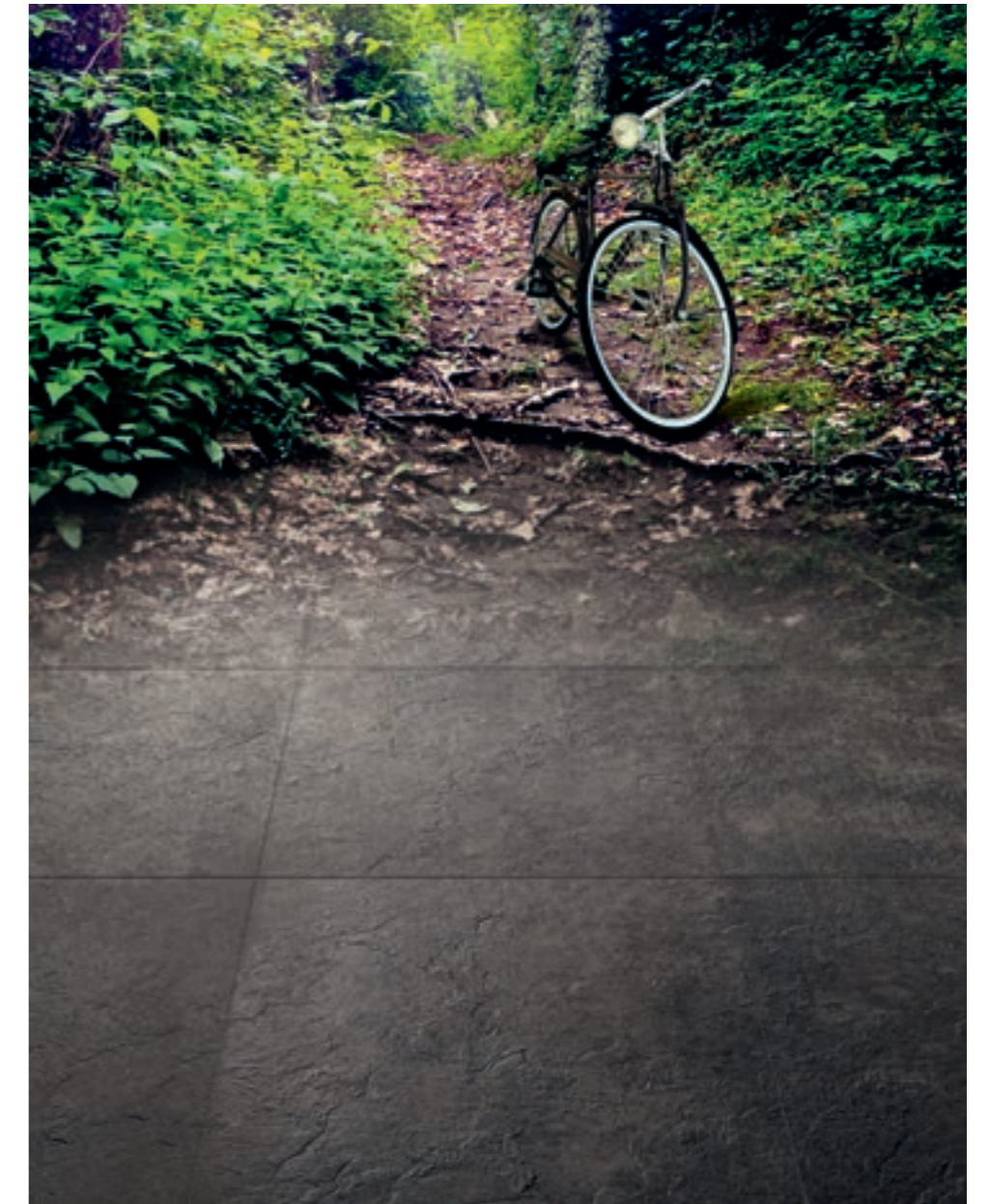

Declaração de verificação de dados com vista a confirmar a percentagem de materiais reciclados nos produtos cerâmicos.
 Statement of verification of data with a view to confirming the percentage of materials recycled in the ceramic products.
 Déclaration de vérification de données en vue de confirmer le pourcentage de matériaux recyclés dans les produits céramiques.
 Declaración de comprobación de datos con el fin de confirmar el porcentaje de materiales reciclados en nuestros productos cerámicos.

Ecotech: Produtos que minimizam o risco de deslizamento.
 Ecotech: Products that minimize the risk of slipping.
 Ecotech: Produits qui réduisent le risque de glissement.
 Ecotech: Productos que minimizan el riesgo de deslizamiento.



45x45 cm	NAT	V3	4	class 2	A	R10	36+	≥0,42
----------	-----	----	---	---------	---	-----	-----	-------



Este produto integra uma elevada percentagem de materiais reciclados, pelo que a cor pode variar de produção para produção.
 This product incorporates a high percentage of recycled materials, so colour may vary from production to production.
 Ce produit contient un pourcentage élevé de matériaux recyclés. La couleur peut donc varier d'une production à l'autre.
 Este producto incorpora un alto porcentaje de materiales reciclados, por lo que su color puede variar de una producción a otra.



ECOTILES

SATURNO

1 cor
colour
couleur
color

1 formato
format
format
formato

2 acabamentos
finishes
finitions
acabados



Pavimentos antiderrapantes garantem a segurança em balneários de espaços desportivos.

Non-slip floor tiles ensure safety in sports changing rooms.

Revêtements de sol antidérapants assurant la sécurité dans les vestiaires des espaces sportifs.

Pavimentos antideslizantes garantizan la seguridad en vestuarios de instalaciones deportivas.

30x30 cm
(12"x12")



NAT · ANTIDERRAPANTE NAT



SATURNO _ ANTIDERRAPANTE SATURNO

ECOTILES



SATURNO
 3521120795 30x30x0,70 cm NAT P56
 ECO TILE 90%



ANTIDERRAPANTE SATURNO
 3521120975 30x30x0,70 cm NAT P56
 ECO TILE 90%

Antiderrapante: Produtos que minimizam o risco de deslizamento.
Antiderrapante: Products that minimize the risk of slipping.
Antiderrapante: Produits qui réduisent le risque de glissement.
Antiderrapante: Productos que minimizan el riesgo de deslizamiento.

30x30 cm	NAT	V3	5	class 1	A	R9	-	≥0,42
30x30 cm	ANTIDERRAPANTE	V3	5	class 3	C	R12	36+	≥0,42



Este produto integra uma elevada percentagem de materiais reciclados, pelo que a cor pode variar de produção para produção.
 This product incorporates a high percentage of recycled materials, so colour may vary from production to production.
 Ce produit contient un pourcentage élevé de matériaux recyclés. La couleur peut donc varier d'une production à l'autre.
 Este producto incorpora un alto porcentaje de materiales reciclados, por lo que su color puede variar de una producción a otra.

SATURNO _ ANTIDERRAPANTE SATURNO

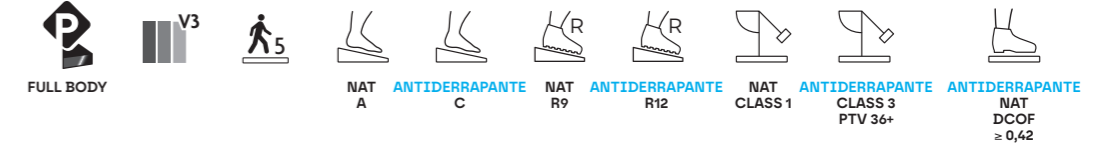

ECO TILES
 PRODUTO QUE INTEGRA MATERIAIS RECICLADOS
 PRODUCT THAT INCORPORATES RECYCLED MATERIALS
 PRODUIT INTEGRANT DES MATÉRIAUX RECYCLÉS
 PRODUCTO QUE INCORPORA MATERIALES RECICLADOS

	PEÇAS · PIECES			CAIXA · BOX			EUROPALETE · EUROPALLET		
				PZ	M²	KG	CX	M²	KG
30x30 cm	NAT	7,0 ±5%		16	1,44	24,0	40	57,60	981

PEÇA · PIECE DG NAT 30x30 cm P07		PEÇA · PIECE RB NAT 9,5x30 cm P04	
--	--	---	--



Declaração de verificação de dados com vista a confirmar a percentagem de materiais reciclados nos produtos cerâmicos.
 Statement of verification of data with a view to confirming the percentage of materials recycled in the ceramic products.
 Déclaration de vérification de données en vue de confirmer le pourcentage de matériaux recyclés dans les produits céramiques.
 Declaración de comprobación de datos con el fin de confirmar el porcentaje de materiales reciclados en nuestros productos cerámicos.

GRAPHIC VARIATION





METALLIC

Reflex	094
Copper	100
Iron	102



METALLIC

REFLEX

5 cores
colours
couleurs
colores

1 formato
format
format
formato

1 acabamento
finish
finition
acabado



O mood urbano e contemporâneo do efeito metalizado resulta em ambientes ecléticos e atuais que refletem a personalidade de quem os projeta, em ambientes interiores ou exteriores.

The urban and contemporary mood of metallic effect for eclectic and modern environments that reflect the personality of the designers, in indoor or outdoor spaces.

Le mood urbain et contemporain de l'effet métallisé, donne lieu à des atmosphères éclectiques et contemporaines qui reflètent la personnalité de ceux qui les conçoivent, dans des ambiances intérieures ou extérieures.

El estilo urbano y contemporáneo del efecto metalizado ofrece espacios ecléticos y modernos que reflejan la personalidad de quien los proyecta, en ambientes interiores o exteriores.

59,2x118,6 cm
(23"x47")

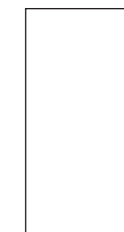

RECT

16

Até 16 desenhos
Up to 16 designs
Jusqu'à 16 dessins
Hasta 16 diseños

Silver



Gold

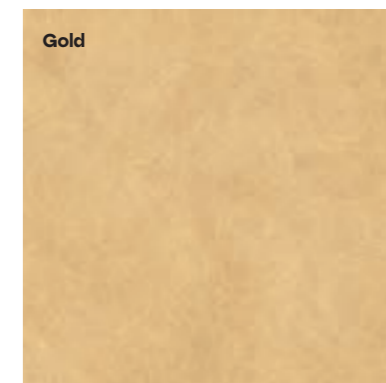

Oxide

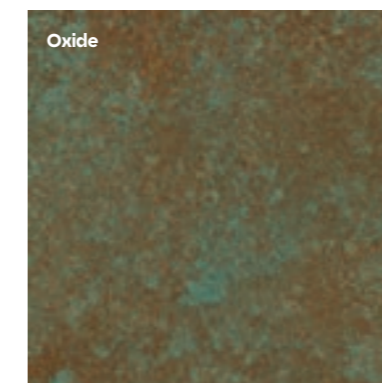

Corten

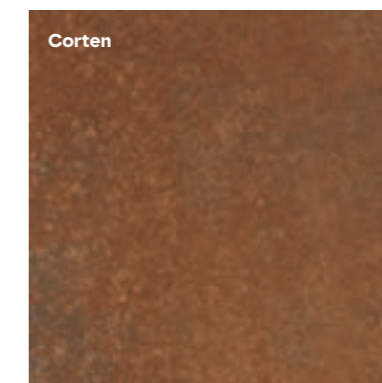

Carbon

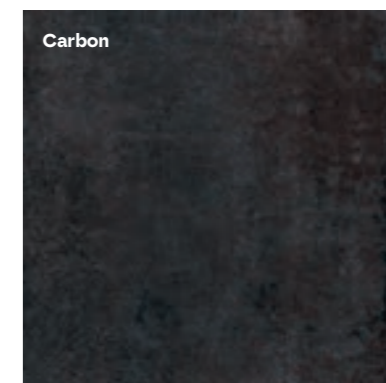

REFLEX

METALLIC



REFLEX SILVER

3121D382V1 59,2x118,6x0,98 cm RECT P114



REFLEX GOLD

3121D383V1 59,2x118,6x0,98 cm RECT P114

REFLEX

METALLIC

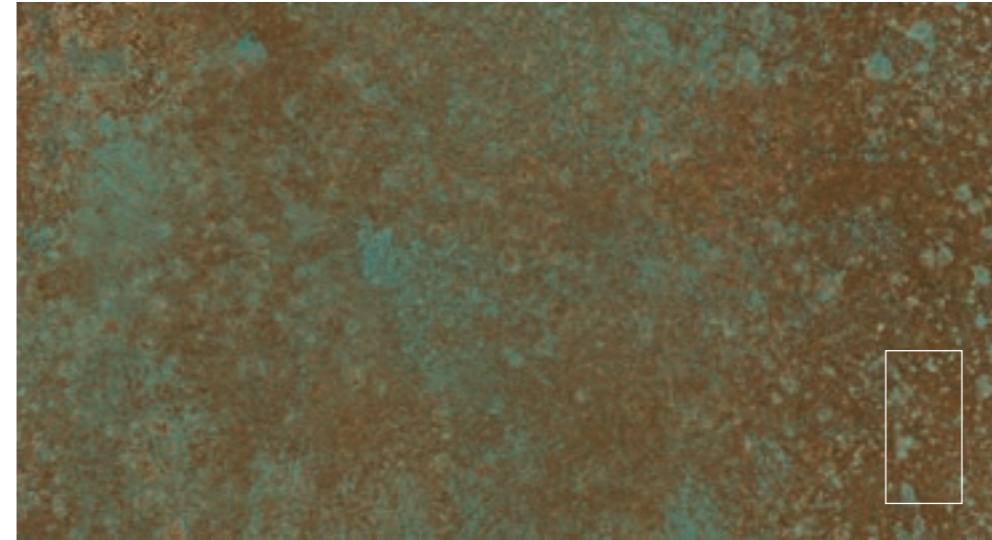

REFLEX OXIDE

3121D386V1 59,2x118,6x0,98 cm RECT P114

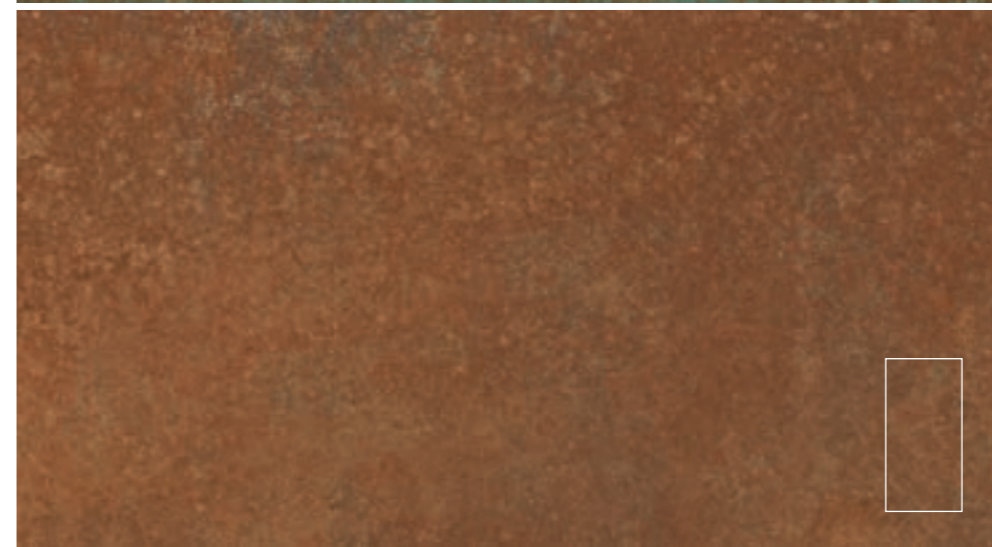

REFLEX CORTEN

3121D384V1 59,2x118,6x0,98 cm RECT P114



REFLEX CARBON

3121D385V1 59,2x118,6x0,98 cm RECT P114



59,2x118,6 cm Silver · Gold	RECT	V2	3	class 1	A	R9	-	≥0,42
59,2x118,6 cm Carbon · Corten · Oxide	RECT	V3	3	class 1	A	R9	-	≥0,42

REFLEX

METALLIC



98 REFLEX CORTEN _ DI ALBA STONE CARBON

Tendo em vista alcançar um efeito global mais real e harmonioso, são produzidas peças diferentes umas das outras com variações de desenho e/ou cores entre elas. For a more genuine and harmonious effect overall, different tiles with design and/or colour variations are produced. Afin d'obtenir un effet global plus réel et harmonieux, nos pièces sont différentes les unes des autres avec des variations de dessin et / ou de nuances entre elles. Para lograr un efecto global más real y armonioso, se producen piezas diferentes unas de otras con variaciones de diseño y/o color.

revigres

REFLEX



PEÇAS · PIECES			CAIXA · BOX			EUROPALETE · EUROPALLET		
			PZ	M²	KG	CX	M²	KG
59,2x118,6 cm	RECT	9,8 ±5%	2	1.40	32.20	30	42.00	987

PEÇA · PIECE		PEÇA · PIECE		PEÇA · PIECE		PEÇA · PIECE		PEÇA · PIECE	
DG	RECT	RB	RECT	DG CF	RECT	DG CF SS	RECT	DG CF CANTO	RECT
29,5x59,2 cm	P18	8x59,2 cm	P12	29,5x59,2 cm	P157	29,5x59,2 cm	P157	29,5x59,2 cm	P207
59,2x118,6 cm	P167	8x118,6 cm	P28						

DG CF / DG CF Canto/DG CF SS: Peças produzidas sob encomenda. Altura do focinho: entre 3 cm e 10 cm. Indicar a altura pretendida no ato da encomenda.
 DG CF / DG CF Canto/DG CF SS: Pieces produced on order. Trim height: 3 to 10 cm. Specify desired height when placing a order.
 DG CF / DG CF Canto/DG CF SS: Pièces produites sur commande. Hauteur du nez de marche : entre 3 cm et 10 cm. Préciser la hauteur souhaitée lors de la commande.
 DG CF / DG CF Canto/DG CF SS: Piezas producidas por encargo. Altura del ángulo: entre 3 y 10 cm. Indicar la altura deseada al realizar el pedido.

DG CF Canto: Disponível em canto esquerdo e direito.
 DG CF Canto: Available in left and right corner.
 DG CF Canto: Disponible en angle gauche et droit.
 DG CF Canto: Canto izquierdo y derecho disponibles.



REFLEX GOLD _ NORDIK WALNUT

METALLIC

revigres



METALLIC

COPPER _ IRON

2 cores
colours
couleurs
colores

3 formatos
formats
formats
formatos

1 acabamento
finish
finition
acabado



COPPER



IRON

Tons metalizados, para ambientes modernos.

Metallic tint for modern environments.

Des tons métallisés pour des environnements modernes.

Tonos metalizados, para ambientes modernos.

59,2x118,6 cm
(23"x47")

59,2x59,2 cm
(23"x23")

30x60 cm
(12"x23")

29,5x59,2 cm
(12"x23")



NAT · RECT

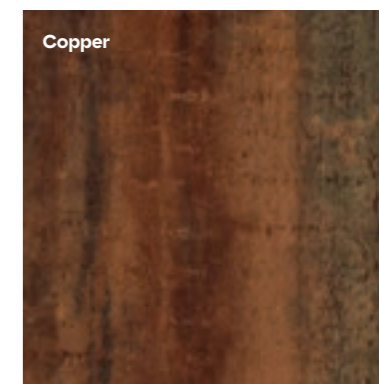

Copper

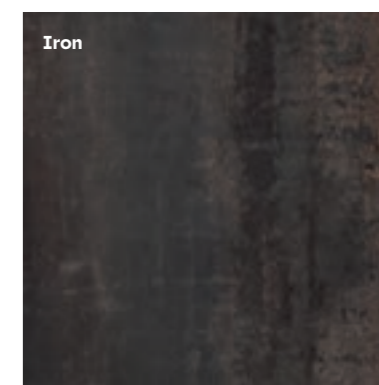

Iron

COPPER _ IRON



COPPER

3571213431	30x60x0,85 cm	NAT	P85
3471213431	29,5x59,2x0,85 cm	RECT	P94
3471133431	59,2x59,2x0,85 cm	RECT	P107
3471D33431	59,2x118,6x0,98 cm	RECT	P127

IRON

3571213451	30x60x0,85 cm	NAT	P85
3471213451	29,5x59,2x0,85 cm	RECT	P94
3471133451	59,2x59,2x0,85 cm	RECT	P107
3471D33451	59,2x118,6x0,98 cm	RECT	P127

30x60 cm	NAT	V3	3
29,5x59,2 · 59,2x59,2 · 59,2x118,6 cm	RECT	V3	3



COPPER _ IRON



STEP COPPER (a)

3321128821	29,5x29,5x0,85 cm	P29 /peça_pieza
[1m² = 11 peças_pieças]		



STEP GOLD (a)

332112Z281	29,5x29,5x0,85 cm	P96 /peça_pieza
[1m² = 11 peças_pieças]		



STEP IRON (a)

3321128801	29,5x29,5x0,85 cm	P29 /peça_pieza
[1m² = 11 peças_pieças]		



STEP SILVER (a)

332112Z291	29,5x29,5x0,85 cm	P96 /peça_pieza
[1m² = 11 peças_pieças]		





METALLIC

METALLIC

PEÇAS · PIECES			CAIXA · BOX			EUROPALETE · EUROPALLET		
		±	PZ	M²	KG	CX	M²	KG
30x60 cm	NAT	8,5 ±5%	8	1.44	28.8	32	46.08	943
29,5x59,2 cm	RECT	8,5 ±5%	8	1.40	28.8	32	44.80	943
59,2x59,2 cm	RECT	8,5 ±5%	4	1.40	28.7	36	50.40	1 053
59,2x118,6 cm	RECT	9,8 ±5%	2	1.40	33.0	30	42.00	1 011

PEÇA · PIECE		PEÇA · PIECE		PEÇA · PIECE		PEÇA · PIECE		PEÇA · PIECE	
DG	RECT	RB	RECT	DG CF	RECT	DG CF SS	RECT	DG CF CANTO	RECT
30x30 cm	P08	9,5x30 cm	P07	29,5x59,2 cm	P157	29,5x59,2 cm	P157	29,5x59,2 cm	P207
30x60 cm	P18	8x60 cm	P10						
29,5x29,5 cm	-	9,5x29,5 cm	-						
29,5x59,2 cm	-	8x59,2 cm	-						
59,2x59,2 cm	-	8x118,6 cm	-						
29,5x118,6 cm	-								
59,2x118,6 cm	-								

DG CF / DG CF Canto/DG CF SS: Peças produzidas sob encomenda. Altura do focinho: entre 3 cm e 10 cm. Indicar a altura pretendida no ato da encomenda.
 DG CF / DG CF Canto/DG CF SS: Pieces produced on order. Trim height: 3 to 10 cm. Specify desired height when placing a order.
 DG CF / DG CF Canto/DG CF SS: Pièces produites sur commande. Hauteur du nez de marche : entre 3 cm et 10 cm. Préciser la hauteur souhaitée lors de la commande.
 DG CF / DG CF Canto/DG CF SS: Piezas producidas por encargo. Altura del ángulo: entre 3 y 10 cm. Indicar la altura deseada al realizar el pedido.

DG CF Canto: Disponível em canto esquerdo e direito.
 DG CF Canto: Available in left and right corner.
 DG CF Canto: Disponible en angle gauche et droit.
 DG CF Canto: Canto izquierdo y derecho disponibles.



COLOURS

NEW	Brick Glossy	108
NEW	Block Glossy	109
NEW	Brick Matte	112
NEW	Block Matte	113
	Retro	116
	Revival	120
	Unicolor	124



COLOURS

BRICK _ BLOCK GLOSSY

6 cores colours couleurs colores 2 formatos formats formatos 1 acabamento finish finition acabado



O revivalismo e brilho do mosaico tradicional com a versatilidade do grés porcelânico, numa paleta de 6 cores.

The revival and glow of traditional mosaics combined with the versatility of porcelain tiles, in a 6 colour palette.

Le retour et la brillance du carrelage traditionnel associé à la polyvalence du grès cérame avec une palette de 6 couleurs.

El resurgimiento y brillo del mosaico tradicional combinado con la versatilidad del grés porcelánico en una paleta de 6 colores.

7,2x29 cm 14,4x14,4 cm
(3"x11") (6"x6")

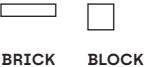

BRICK BLOCK



40
Até 40 desenhos
Up to 40 designs
Jusqu'à 40 dessins
Hasta 40 diseños

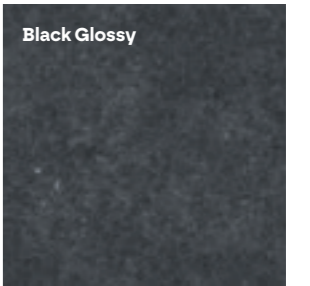
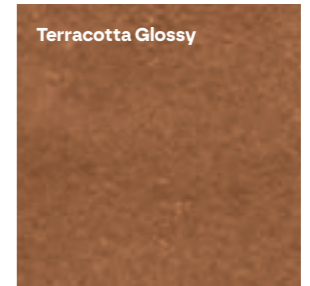
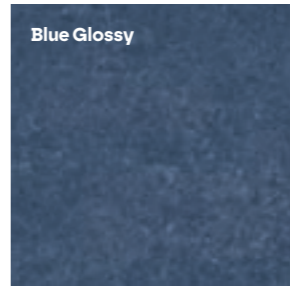
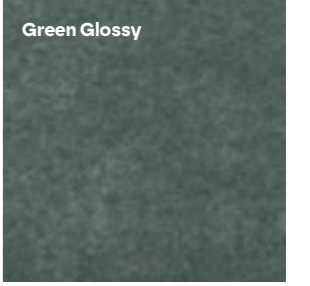
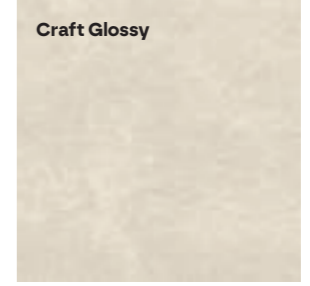

BRICK _ BLOCK GLOSSY



BRICK WHITE GLOSSY

33119187V1 7,2x29x0,85 cm P97



BRICK CRAFT GLOSSY

33119188V1 7,2x29x0,85 cm P97



BRICK GREEN GLOSSY

33119197V1 7,2x29x0,85 cm P97



BRICK BLUE GLOSSY

33119189V1 7,2x29x0,85 cm P97



BRICK TERRACOTTA GLOSSY

33119190V1 7,2x29x0,85 cm P97



BRICK BLACK GLOSSY

33119191V1 7,2x29x0,85 cm P97



BLOCK WHITE GLOSSY

33119199V1 14,4x14,4x0,85 cm P97



BLOCK CRAFT GLOSSY

331191Q001 14,4x14,4x0,85 cm P97



BLOCK GREEN GLOSSY

331191Q011 14,4x14,4x0,85 cm P97



BLOCK BLUE GLOSSY

331191Q021 14,4x14,4x0,85 cm P97



BLOCK TERRACOTTA GLOSSY

331191Q031 14,4x14,4x0,85 cm P97



BLOCK BLACK GLOSSY

331191Q041 14,4x14,4x0,85 cm P97



BRICK BLUE GLOSSY

BRICK _ BLOCK GLOSSY



	PEÇAS · PIECES		CAIXA · BOX			EUROPALETTE · EUROPALLET		
	±		PZ	M ²	KG	CX	M ²	KG
7,2x29 cm	8,5	±5%	40	0.85	16.07	30	25.20	502.95
14,4x14,4 cm	8,5	±5%	40	0.84	15,88	30	20.20	476,4



BRICK TERRACOTTA GLOSSY



(*) Grés Porcelânico Esmaltado adequado para revestimento interior e exterior.

(*) Glazed Porcelain suitable for internal and external walls.

(*) Grès Cérame Emailé convient aux murs intérieurs et extérieurs.

(*) Gres Porcelánico Técnico adecuado para revestimiento interior y exterior.

Tendo em vista alcançar um efeito global mais real e harmonioso, são produzidas peças diferentes umas das outras com variações de desenho e/ou cores entre elas.

For a more genuine and harmonious effect overall, different tiles with design and/or colour variations are produced.

Afin d'obtenir un effet global plus réel et harmonieux, nos pièces sont différentes les unes des autres avec des variations de dessin et / ou de nuances entre elles.

Para lograr un efecto global más real y armonioso, se producen piezas diferentes unas de otras con variaciones de diseño y/o color.

COLOURS



COLOURS

BRICK _ BLOCK MATTE

6 cores colours couleurs colores 2 formatos formats formats 1 acabamento finish finition acabado

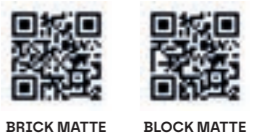

O pequeno formato do mosaico tradicional combinado com a versatilidade do grés porcelânico. Para revestimento e pavimento, interior e exterior.

Small mosaic tiles combined with the versatility of porcelain tiles. For indoor and outdoor walls and floors.

Le petit format du carrelage traditionnel associé à la polyvalence du grès cérame. Revêtements de murs et de sols, pour les espaces intérieurs et extérieurs.

El pequeño formato del mosaico tradicional combinado con la versatilidad del gres porcelánico. Para revestimientos y pavimentos interiores y exteriores.



7,2x29 cm (3"x11") 14,4x14,4 cm (6"x6")



BRICK BLOCK

COLOURS

40
Até 40 desenhos
Up to 40 designs
Jusqu'à 40 dessins
Hasta 40 diseños

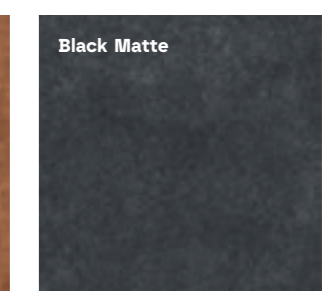
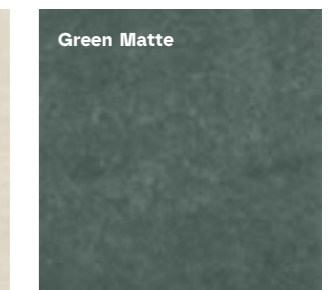

BRICK _ BLOCK MATTE

BRICK WHITE MATTE
33110B92V1 7,2x29x0,85 cm P97

BRICK CRAFT MATTE
33110B93V1 7,2x29x0,85 cm P97

BRICK GREEN MATTE
33110B98V1 7,2x29x0,85 cm P97

BRICK BLUE MATTE
33110B94V1 7,2x29x0,85 cm P97

BRICK TERRACOTTA MATTE
33110B95V1 7,2x29x0,85 cm P97

BRICK BLACK MATTE
33110B96V1 7,2x29x0,85 cm P97

BLOCK WHITE MATTE
33110BQ051 14,4x14,4x0,85 cm P97

BLOCK CRAFT MATTE
33110BQ061 14,4x14,4x0,85 cm P97

BLOCK GREEN MATTE
33110BQ071 14,4x14,4x0,85 cm P97

BLOCK BLUE MATTE
33110BQ081 14,4x14,4x0,85 cm P97

BLOCK TERRACOTTA MATTE
33110BQ091 14,4x14,4x0,85 cm P97

BLOCK BLACK MATTE
33110BQ101 14,4x14,4x0,85 cm P97



BLOCK TERRACOTA MATTE



14,4x14,4 cm	V2	2	class 1	A	≥0,42
7,9x29 cm	V2	2	class 1	A	≥0,42

COLOURS

BRICK _ BLOCK MATTE



PEÇAS · PIECES	CAIXA · BOX			EUROPALETE · EUROPALLET		
	±	PZ	M ² KG	CX	M ² KG	
7,2x29 cm	8,5 ±5%	40	0.85 16.07	30	25.20 502.95	
14,4x14,4 cm	8,5 ±5%	40	0.84 15,88	30	20.20 476,4	



BLOCK GREEN MATTE _ RAINFOREST GREEN

COLOURS

Tendo em vista alcançar um efeito global mais real e harmonioso, são produzidas peças diferentes umas das outras com variações de desenho e/ou cores entre elas. For a more genuine and harmonious effect overall, different tiles with design and/or colour variations are produced. Afin d'obtenir un effet global plus réel et harmonieux, nos pièces sont différentes les unes des autres avec des variations de dessin et / ou de nuances entre elles. Para lograr un efecto global más real y armonioso, se producen piezas diferentes unas de otras con variaciones de diseño y/o color.



RETRO AQUA BRILHO _ RETRO WHITE BRILHO _ CITYZEN CARBON

COLOURS

RETRO

9 cores
colours
couleurs
colores

1 formato
format
formato

1 acabamento
finish
finition
acabado



Uma retrospectiva moderna do mosaico em pequeno formato, com brilhos e cores vibrantes.

A modern revival of the small format tile, with shine and vibrant colours.

Une rétrospective moderne du carrelage de petit format, aux reflets lumineux et aux couleurs vibrantes.

Una retrospectiva moderna del mosaico en pequeño formato, con brillos y colores vibrantes.

20x40 cm
(8"x16")



BiM

NAT

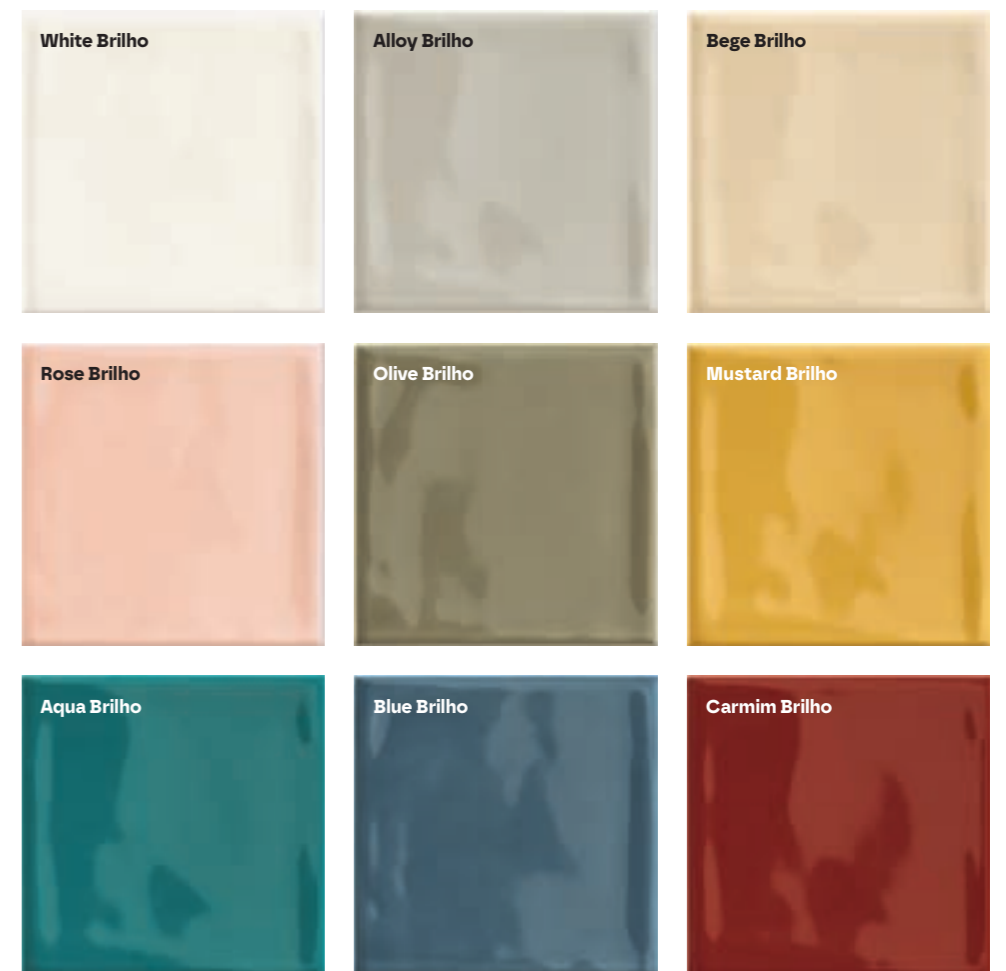

RETRO

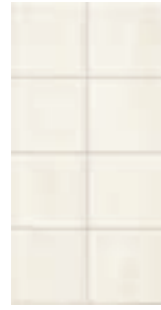

RETRO WHITE BRILHO

3100C9G991 20x40x0,90 cm NAT P72



RETRO ALLOY BRILHO

3100C90G61 20x40x0,90 cm NAT P72



RETRO BEGE BRILHO

3100C90G01 20x40x0,90 cm NAT P72

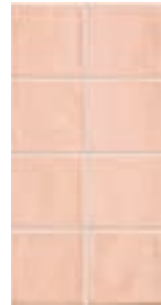

RETRO ROSE BRILHO

3100C90G11 20x40x0,90 cm NAT P72



RETRO OLIVE BRILHO

3100C90G21 20x40x0,90 cm NAT P72



RETRO MUSTARD BRILHO

3100C90G31 20x40x0,90 cm NAT P72



RETRO AQUA BRILHO

3100C90G41 20x40x0,90 cm NAT P72

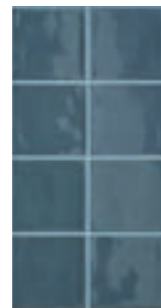

RETRO BLUE BRILHO

3100C90G51 20x40x0,90 cm NAT P72

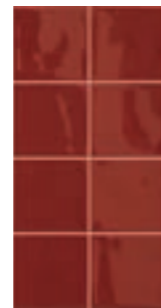

RETRO CARMIM BRILHO

3100C9G981 20x40x0,90 cm NAT P84

RETRO



PEÇAS · PIECES			CAIXA · BOX			EUROPALETE · EUROPALLET		
±			PZ	M ²	KG	CX	M ²	KG
20x40 cm	NAT	9,0 ±5%	9	0,72	10,4	96	69,12	1 019



RETRO CARMIM BRILHO _ RETRO WHITE BRILHO
CROMÁTICA ICE _ CROMÁTICA TERRACOTTA



RETRO ROSE BRILHO

COLOURS

COLOURS

Devido às características deste produto, recomenda-se a betumação dos pré-cortes das peças.

Due to the characteristics of the product, grouting of the pre-cut tiles is advisable.

En raison des caractéristiques de ce produit, il est recommandé de sceller les prédécoupes des carreaux.

Debido a las características de este producto, se recomienda el rejuntado de los precortes de las piezas.

Dado o efeito deste produto, as peças devem ser aplicadas sempre no mesmo sentido, seguindo a orientação do dorso.

Given the effect of the product, tiles must always be laid out facing same direction, following the orientation of the back.

En raison de l'effet de ce produit, les carreaux doivent toujours être posés dans le même sens, en suivant l'orientation de sa face interne.

Dado el efecto de este producto, las piezas deben aplicarse siempre en el mismo sentido, siguiendo la orientación del dorso.



COLOURS

REVIVAL

9 cores
colours
couleurs
colores

1 formato
format
format
formato

1 acabamento
finish
finition
acabado



O regresso do mosaico tradicional com brilho e cores contemporâneas.

The return of the traditional tile with shine and contemporary colours.

Le retour du carreau traditionnel avec luminosité et les couleurs contemporaines.

El regreso del mosaico tradicional con brillos y con colores contemporâneos.

30x45 cm
(12"x18")



BiM

NAT

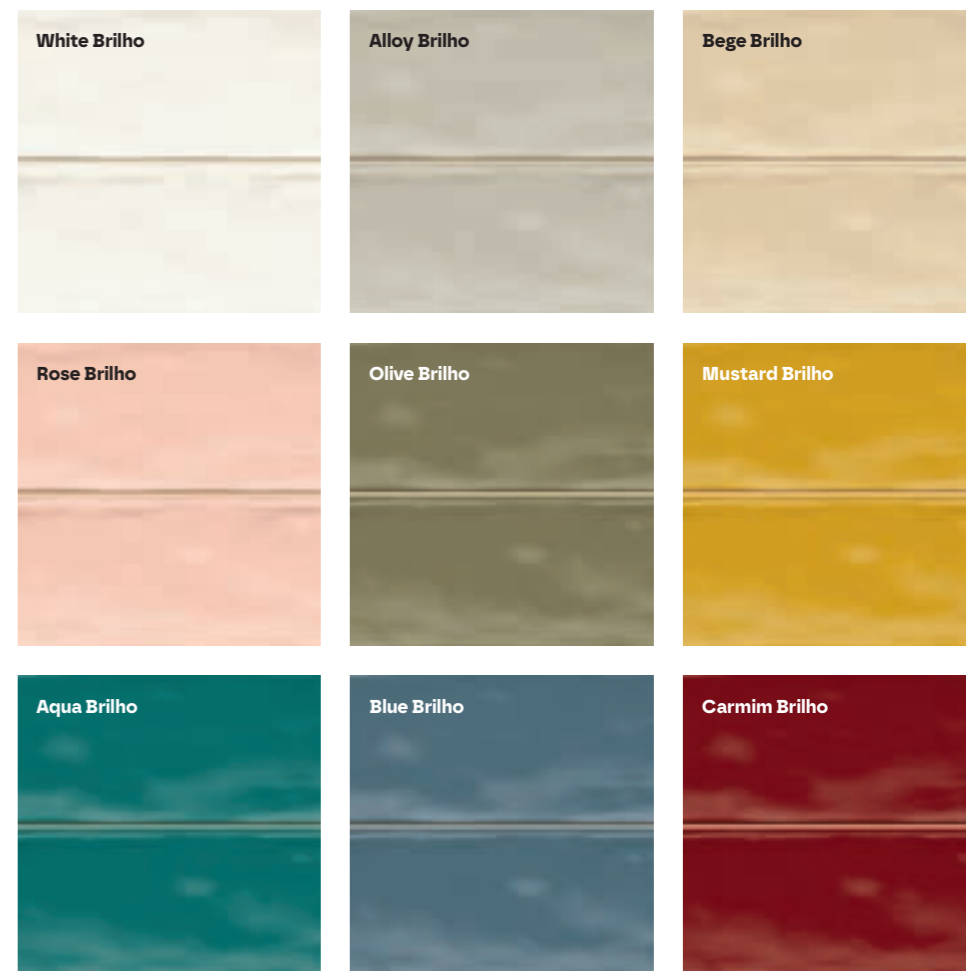

REVIVAL



REVIVAL WHITE BRILHO

3100E5G581 30x45x0,90 cm NAT P72

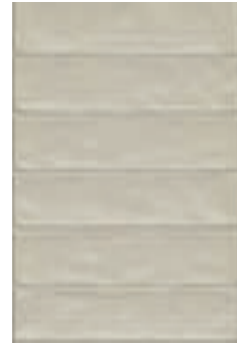

REVIVAL ALLOY BRILHO

3100E5G591 30x45x0,90 cm NAT P72

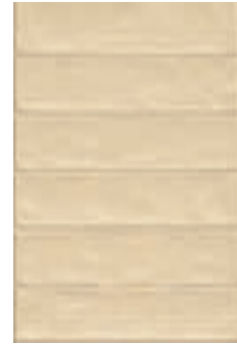

REVIVAL BEGE BRILHO

3100E5G601 30x45x0,90 cm NAT P72

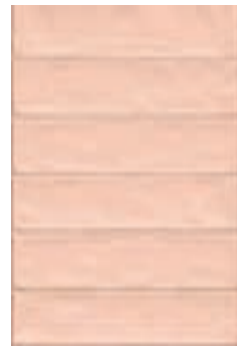

REVIVAL ROSE BRILHO

3100E5G611 30x45x0,90 cm NAT P72



REVIVAL OLIVE BRILHO

3100E5G621 30x45x0,90 cm NAT P72



REVIVAL MUSTARD BRILHO

3100E5G631 30x45x0,90 cm NAT P72



REVIVAL AQUA BRILHO

3100E5G641 30x45x0,90 cm NAT P72



REVIVAL BLUE BRILHO

3100E5G651 30x45x0,90 cm NAT P72



REVIVAL CARMIM BRILHO

3100E5G661 30x45x0,90 cm NAT P84

REVIVAL



PEÇAS · PIECES			CAIXA · BOX			EUROPALETE · EUROPALLET		
±			PZ	M ²	KG	CX	M ²	KG
30x45 cm	NAT	9,0 ±5%	11	1,5	23,9	48	72	1 166



REVIVAL MUSTARD BRILHO



REVIVAL WHITE BRILHO

COLOURS

COLOURS

Devido às características deste produto, recomenda-se a betumação dos pré-cortes das peças.
 Due to the characteristics of the product, grouting of the pre-cut tiles is advisable.
 En raison des caractéristiques de ce produit, il est recommandé de sceller les prédécoupes des carreaux.
 Debido a las características de este producto, se recomienda el rejuntado de los precortes de las piezas.

Dado o efeito deste produto, as peças devem ser aplicadas sempre no mesmo sentido, seguindo a orientação do tardo.
 Given the effect of the product, tiles must always be laid out facing same direction, following the orientation of the back.
 En raison de l'effet de ce produit, les carreaux doivent toujours être posés dans le même sens, en suivant l'orientation de sa face interne.
 Dado el efecto de este producto, las piezas deben aplicarse siempre en el mismo sentido, siguiendo la orientación del dorso.



YANG BEGE _ NEUTRAL MARFIM MATE _ OMNISTONE BONE

COLOURS

UNICOLOR

7 cores colours couleurs colores 6 formatos formats formats 2 acabamentos finishes finitions acabados



Mil e uma cores. Para ambientes arrojados ou espaços mais neutros.

Thousand and one colours. For bold environments or more neutral spaces.

Mille et une couleurs. Pour les ambiances audacieuses ou les espaces plus neutres.

Mil y un colores. Para ambientes atrevidos o espacios más neutros.

39,4x118,6 cm (16"x47") 29,5x88,9 cm (12"x35") 30x60 cm (12"x23") 29,5x59,2 cm (12"x23") 30x45 cm (12"x18") 20x40 cm (8"x16") 16,5x19 cm (6"x7")

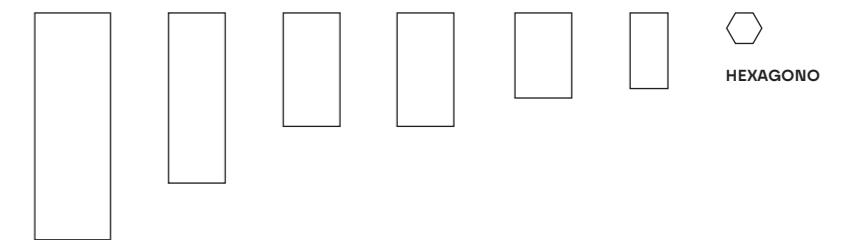

NAT · RECT



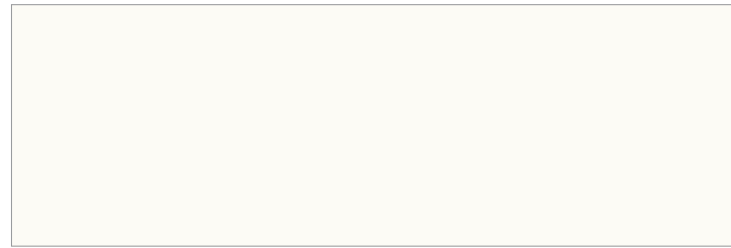

WHITE COOL

3100211G31	30x60x0,90 cm	NAT	P64
3101211G31	29,5x59,2x0,90 cm	RECT	P75
3101G81G31	29,5x88,9x1,23 cm	RECT	P88
3101T91G31	39,4x118,6x1,23 cm	RECT	P99



MARFIM MATE

3100218A41	30x60x0,90 cm	NAT	P64
3101218A41	29,5x59,2x0,90 cm	RECT	P75
3101G88A41	29,5x88,9x1,23 cm	RECT	P88
3101T98A41	39,4x118,6x1,23 cm	RECT	P99

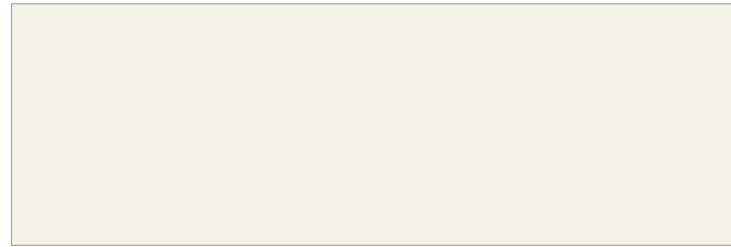

ALLOY MATE

3100214G31	30x60x0,90 cm	NAT	P64
3101214G31	29,5x59,2x0,90 cm	RECT	P75
3101G84G31	29,5x88,9x1,23 cm	RECT	P88
3101T94G31	39,4x118,6x1,23 cm	RECT	P99

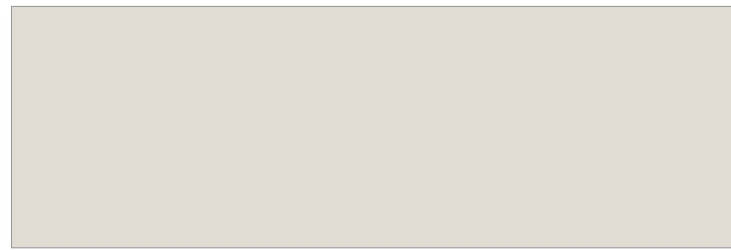

SMOG MATE

3100214G41	30x60x0,90 cm	NAT	P64
3101214G41	29,5x59,2x0,90 cm	RECT	P75
3101G84G41	29,5x88,9x1,23 cm	RECT	P88
3101T94G41	39,4x118,6x1,23 cm	RECT	P99



PRETO MATE

3101T94G51	39,4x118,6x1,23 cm	RECT	P102
------------	--------------------	------	------



TWIN WHITE

3301T9F631	39,4x118,6x1,23 cm	RECT	P127 /peça_piece
------------	--------------------	------	------------------

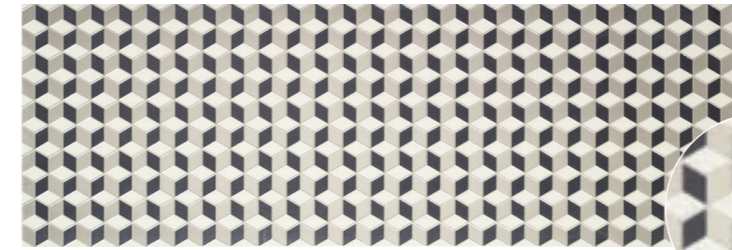

KOOKY

3301T9F651	39,4x118,6x1,23 cm	RECT	P149 /peça_piece
------------	--------------------	------	------------------

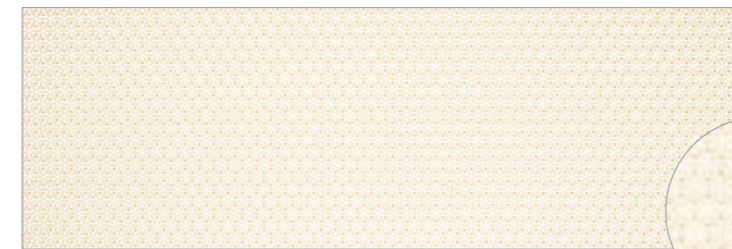

YANG BEGE

3301T9F641	39,4x118,6x1,23 cm	RECT	P135 /peça_piece
------------	--------------------	------	------------------

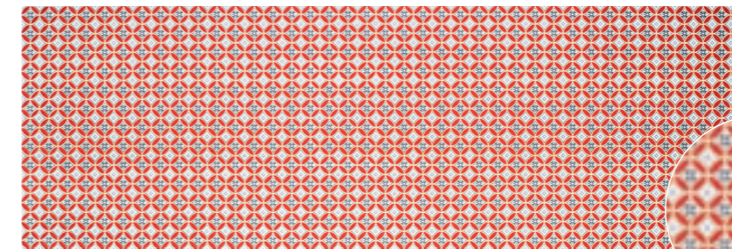

ORIENTAL

3301T9F661	39,4x118,6x1,23 cm	RECT	P167 /peça_piece
------------	--------------------	------	------------------

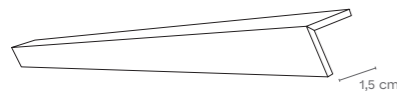

perfil			
1,5x39,4x1,23 cm	RECT	P28 /peça_piece	

PERFIL: produzido de acordo com quantidades mínimas de 10 peças.
 PERFIL: produced in minimum quantities of 10 pieces.
 PERFIL: produites selon des quantités minimales de 10 pièces.
 PERFIL: producidas en cantidades mínimas de 10 piezas.

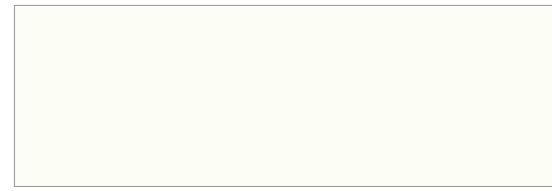

BRANCO ORIENTE

3121C9A011	20x40x0,84 cm	NAT	P60
3121E5A011	30x45x0,90 cm	NAT	P62
312121A191	30x60x0,90 cm	NAT	P64
312121A231	29,5x59,2x0,90 cm	RECT	P75
3101G8A011	29,5x88,9x1,23 cm	RECT	P88



BRANCO MATE

3121C9A021	20x40x0,84 cm	NAT	P60
3100E5A021	30x45x0,90 cm	NAT	P62
312121A271	30x60x0,90 cm	NAT	P64
312121A481	29,5x59,2x0,90 cm	RECT	P75
3101G8A481	29,5x88,9x1,23 cm	RECT	P88



MARFIM BRILHO

31002133C1	30x60x0,90 cm	NAT	P64
31012133C1	29,5x59,2x0,90 cm	RECT	P75
3101G833C1	29,5x88,9x1,23 cm	RECT	P88



ALLOY BRILHO

31002117C1	30x60x0,90 cm	NAT	P64
31012117C1	29,5x59,2x0,90 cm	RECT	P75



IRON BRILHO

31002118C1	30x60x0,90 cm	NAT	P69
31012118C1	29,5x59,2x0,90 cm	RECT	P80



PRETO BRILHO

3100219C61	30x60x0,90 cm	NAT	P69
3101219C61	29,5x59,2x0,90 cm	RECT	P80



AURA WHITE

3301G8F671	29,5x88,9x1,23 cm	RECT	P87 /peça_pieza
------------	-------------------	------	------------------------



VIBES

3301G8F701	29,5x88,9x1,23 cm	RECT	P96 /peça_pieza
------------	-------------------	------	------------------------



FLAIR BEGE

3301G8F681	29,5x88,9x1,23 cm	RECT	P87 /peça_pieza
------------	-------------------	------	------------------------



FLAIR GRIS

3301G8F691	29,5x88,9x1,23 cm	RECT	P87 /peça_pieza
------------	-------------------	------	------------------------



INSIGHT

330121F731	29,5x59,2x0,90 cm	RECT	P40 /peça_pieza
------------	-------------------	------	------------------------



YOSHI

330121F741	29,5x59,2x0,90 cm	RECT	P40 /peça_pieza
------------	-------------------	------	------------------------



RAKU BRONZE

330121F721	29,5x59,2x0,90 cm	RECT	P40 /peça_pieza
------------	-------------------	------	------------------------



RAKU GRIS

330121F711	29,5x59,2x0,90 cm	RECT	P40 /peça_pieza
------------	-------------------	------	------------------------



SMOG MATE _ ALLOY MATE _ FLAIR GRIS _ CROMÁTICA CARBON



MARFIM MATE _ ROKU BRONZE

UNICOLOR



HEXAGONO
WHITE COOL

3301V38G41 16,5x19x1,23 cm P261
[1m² = 41 peças_pieces]



HEXAGONO
MARFIM MATE

3301V38G11 16,5x19x1,23 cm P261
[1m² = 41 peças_pieces]



HEXAGONO
ALLOY MATE

3301V38G01 16,5x19x1,23 cm P261
[1m² = 41 peças_pieces]



HEXAGONO
SMOG MATE

3301V38G31 16,5x19x1,23 cm P261
[1m² = 41 peças_pieces]



HEXAGONO
PRETO MATE

3301V38G21 16,5x19x1,23 cm P277
[1m² = 41 peças_pieces]



LOOP WHITE COOL (a)

3301U7F631 29x31x1,23 cm P96 /peça_piece
[1m² = 15 peças_pieces]



LOOP MARFIM MATE (a)

3301U7F651 29x31x1,23 cm P96 /peça_piece
[1m² = 15 peças_pieces]

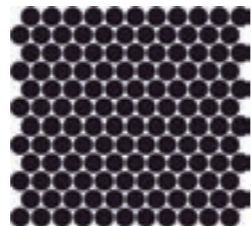

LOOP PRETO MATE (a)

3301U7F641 29x31x1,23 cm P96 /peça_piece
[1m² = 15 peças_pieces]

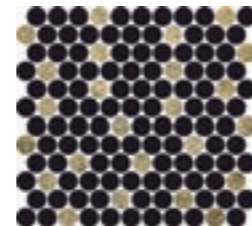

LOOP PRETO SILVER (a) (b)

3301U7F741 29x31x1,23 cm P138 /peça_piece
[1m² = 15 peças_pieces]



LOOP ALLOY MATE (a)

3301U7F661 29x31x1,23 cm P96 /peça_piece
[1m² = 15 peças_pieces]

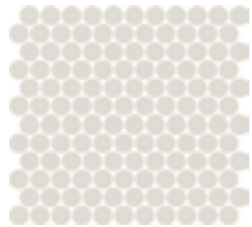

LOOP SMOG MATE (a)

3301U7F671 29x31x1,23 cm P96 /peça_piece
[1m² = 15 peças_pieces]

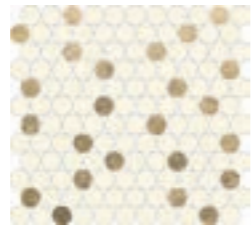

LOOP MARFIM SILVER (a) (b)

3301U7F751 29x31x1,23 cm P138 /peça_piece
[1m² = 15 peças_pieces]

BARRA STILETTO ORO (c)

3001I2B291 0,5x59,2x0,90 cm RECT P25 /peça_piece

BARRA STILETTO PRATA (c)

3001I2B301 0,5x59,2x0,90 cm RECT P25 /peça_piece

UNICOLOR



BITTY WHITE COOL (a)

330112F781 30x30x1,23 cm P26 /peça_piece
[1m² = 12 peças_pieces]



BITTY MARFIM MATE (a)

330112F761 30x30x1,23 cm P26 /peça_piece
[1m² = 12 peças_pieces]

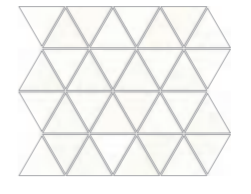

MOODY WHITE (a) (d)

Bases: White Cool + Branco Oriente
330112F821 27x30x0,90 cm P20 /peça_piece
[1m² = 14 peças_pieces]

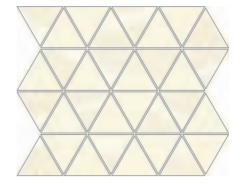

MOODY MARFIM (a) (d)

Bases: Marfim Mate + Marfim Brilho
330112F811 27x30x0,90 cm P20 /peça_piece
[1m² = 14 peças_pieces]



BITTY ALLOY MATE (a)

330112F751 30x30x1,23 cm P26 /peça_piece
[1m² = 12 peças_pieces]



BITTY SMOG MATE (a)

330112F771 30x30x1,23 cm P26 /peça_piece
[1m² = 12 peças_pieces]

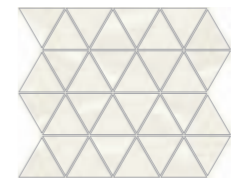

MOODY ALLOY (a) (d)

Bases: Alloy Mate + Alloy Brilho
330112F801 27x30x0,90 cm P20 /peça_piece
[1m² = 14 peças_pieces]

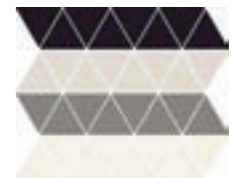

MOODY MIX (a) (d)

Bases: Preto Brilho + Smog Mate + Iron Brilho + Alloy Mate
330112F831 27x30x0,90 cm P20 /peça_piece
[1m² = 14 peças_pieces]



BITTY PRETO MATE (a)

330112F791 30x30x1,23 cm P26 /peça_piece
[1m² = 12 peças_pieces]

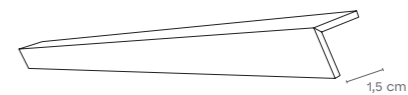

perfil

1,5x29,5x0,90 cm	RECT	P20 /peça_piece
1,5x59,2x0,90 cm	RECT	P32 /peça_piece

PERFIL: produzido de acordo com quantidades mínimas de 10 peças.
PERFIL: produced in minimum quantities of 10 pieces.
PERFIL: produites selon des quantités minimales de 10 pièces.
PERFIL: producidas en cantidades mínimas de 10 piezas.



LOOP SMOG MATE



HEXAGONO WHITE COOL _ HEXAGONO PRETO MATE

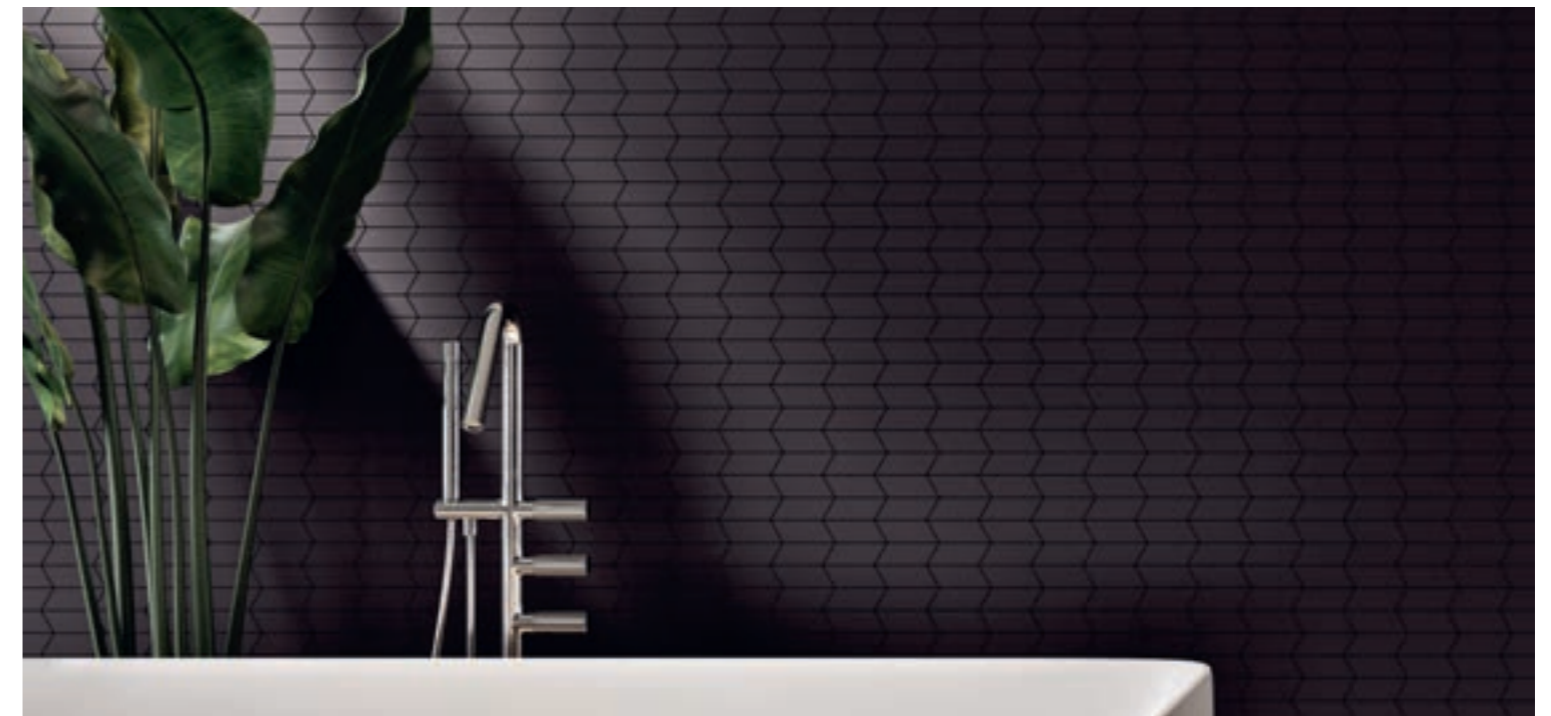

BITTY PRETO MATE

FAIT-DIVERS BY JÚLIO RESENDE

UNICOLOR



Expressões bem-humoradas de grafismo livre.

Witty expressions of free graphics.

Expressions amusantes de graphisme libre.

Expresiones divertidas de grafismo libre.

	PEÇAS · PIECES	±	CAIXA · BOX			EUROPALETE · EUROPALLET		
			PZ	M²	KG	CX	M²	KG
20x20 cm	NAT · FAIT - DIVERS	8,1 ±5%	6	-	3.5	-	-	-
20x40 cm	NAT	8,5 ±5%	10	0.80	11.5	96	76.80	1120
30x45 cm	NAT	9,0 ±5%	11	1.50	23.9	48	72.00	1166
30x60 cm	NAT	9,0 ±5%	8	1.44	23.2	32	46.08	1083
29,5x59,2 cm	RECT	9,0 ±5%	8	1.40	23.2	32	44.80	1083
29,5x88,9 cm	RECT	12,3 ±0,5 mm	4	1.05	22.0	40	42.00	901
39,4x118,6 cm	RECT	12,3 ±0,5 mm	3	1.40	29.0	18	25.20	543

COLOURS



FAIT-DIVERS 1

3100022D41 20x20x0,81 cm NAT P138 /peça_piece

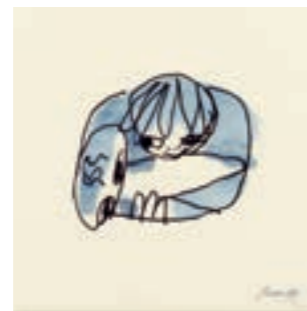

FAIT-DIVERS 2

3100022D51 20x20x0,81 cm NAT P138 /peça_piece



FAIT-DIVERS 3

3100022D61 20x20x0,81 cm NAT P138 /peça_piece

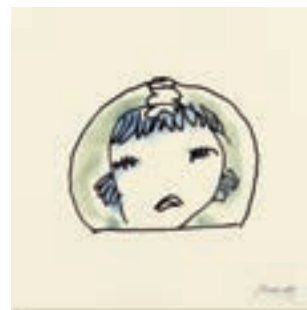

FAIT-DIVERS 4

3100022D71 20x20x0,81 cm NAT P138 /peça_piece



FAIT-DIVERS 5

3100022D81 20x20x0,81 cm NAT P138 /peça_piece

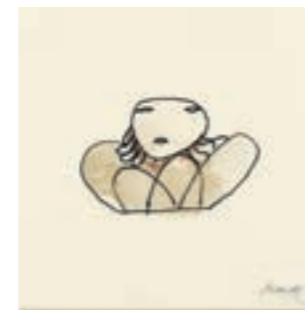

FAIT-DIVERS 6

3100022D91 20x20x0,81 cm NAT P138 /peça_piece

COLOURS





RELIEFS

Chic	138
Ethos	142
Unite	146
Neutral	156
Bold _ Flick	160
Mix Reliefs	164



RELIEFS

CHIC

2 cores
colours
couleurs
colores

1 formato
format
formato

1 acabamento
finish
finition
acabado



Charme natural em revestimentos com detalhes delicados e suaves, para áreas interiores.

Effortless charm in wall tiles with delicate and gentle details for indoor use.

Charme naturel en revêtements avec des détails délicats et doux, pour les espaces intérieurs.

Encanto natural en revestimientos con detalles delicados y suaves, para espacios interiores.

39,4x118,6 cm
(16"x47")

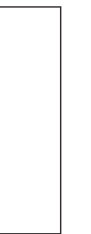

RECT

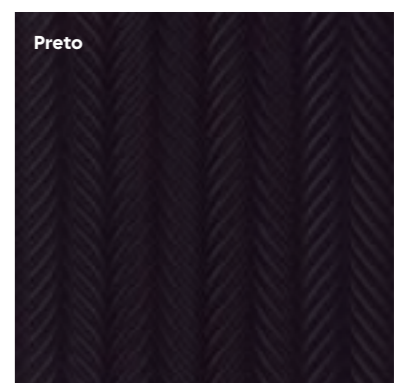
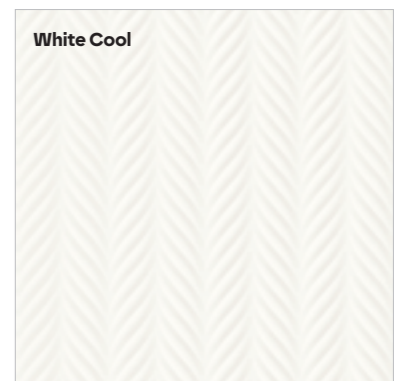

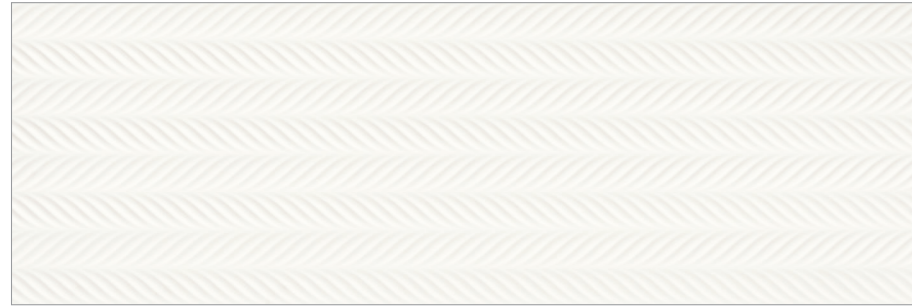

CHIC WHITE COOL (*)

3101T97G91 39,4x118,6x1,23 cm RECT P99

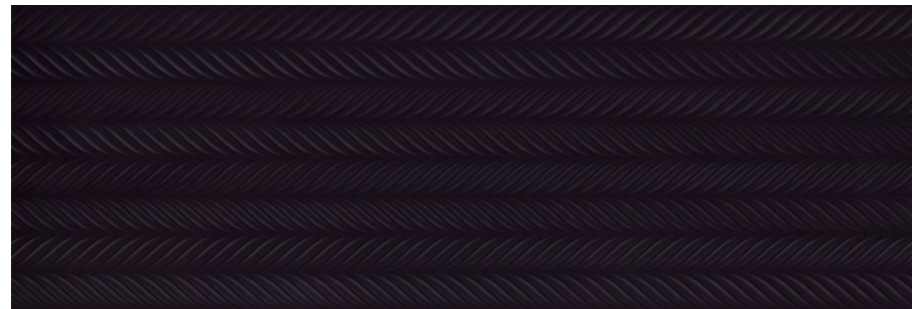

CHIC PRETO MATE (*)

3101T97G81 39,4x118,6x1,23 cm RECT P102

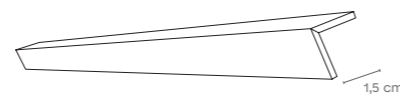

perfil
1,5x39,4x1,23 cm RECT P28 /peça_pieza

PERFIL: produzido de acordo com quantidades mínimas de 10 peças.
PERFIL: produced in minimum quantities of 10 pieces.
PERFIL: produites selon des quantités minimales de 10 pièces.
PERFIL: producidas en cantidades mínimas de 10 piezas.

PEÇAS · PIECES			CAIXA · BOX			EUROPALETE · EUROPALLET		
		±	PZ	M ²	KG	CX	M ²	KG
39,4x118,6 cm	RECT	12,3 ±0,5 mm	3	1,40	29,00	18	25,20	543



(*) Dado o efeito deste produto, as peças devem ser aplicadas sempre no mesmo sentido, seguindo a orientação do dorso.
(*) Given the effect of the product, tiles must always be laid out facing same direction, following the orientation of the back.
(*) En raison de l'effet de ce produit, les carreaux doivent toujours être posés dans le même sens, en suivant l'orientation de sa face interne.
(*) Dado el efecto de este producto, las piezas deben aplicarse siempre en el mismo sentido, siguiendo la orientación del dorso.



RELIEFS

ETHOS

2 cores
colours
couleurs
colores

1 formato
format
format
formato

1 acabamento
finish
finition
acabado



Revestimentos singulares com linhas que dão continuidade aos espaços.

Unique ceramic wall tiles creating lines that lend continuity to space.

Revêtements singuliers avec des lignes qui donnent une continuité aux espaces.

Revestimientos singulares con líneas que dan continuidad a los espacios.

39,4x118,6 cm
(16"x47")

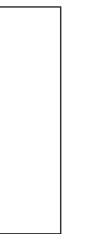

RECT



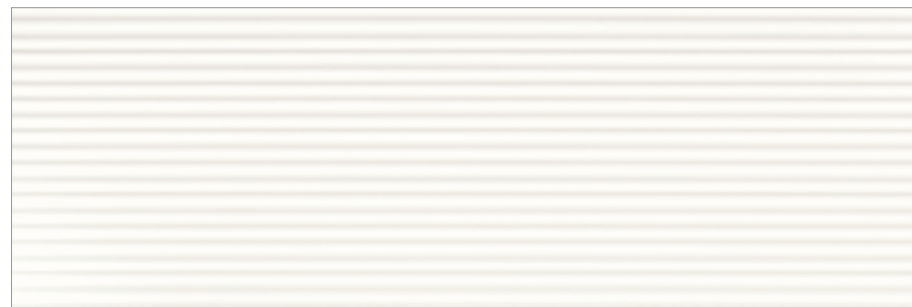

ETHOS WHITE COOL (*)

3101T97G71 39,4x118,6x1,23 cm RECT P99

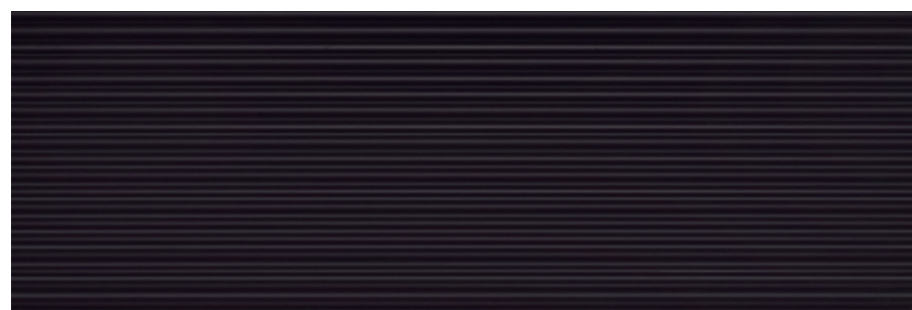

ETHOS PRETO MATE (*)

3101T97G61 39,4x118,6x1,23 cm RECT P102

PEÇAS · PIECES			CAIXA · BOX			EUROPALETTE · EUROPALLET		
		±	PZ	M ²	KG	CX	M ²	KG
39,4x118,6 cm	RECT	12,3 ±0,5 mm	3	1,40	29,00	18	25,20	543

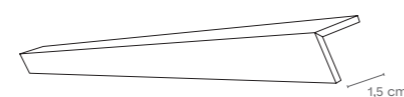

perfil
1,5x39,4x1,23 cm RECT P28 /peça_pieza

PERFIL: produzido de acordo com quantidades mínimas de 10 peças.
 PERFIL: produced in minimum quantities of 10 pieces.
 PERFIL: produites selon des quantités minimales de 10 pièces.
 PERFIL: producidas en cantidades mínimas de 10 piezas.



(*) Dado o efeito deste produto, as peças devem ser aplicadas sempre no mesmo sentido, seguindo a orientação do tardo.
 (*) Given the effect of the product, tiles must always be laid out facing same direction, following the orientation of the back.
 (*) En raison de l'effet de ce produit, les carreaux doivent toujours être posés dans le même sens, en suivant l'orientation de sa face interne.
 (*) Dado el efecto de este producto, las piezas deben aplicarse siempre en el mismo sentido, siguiendo la orientación del dorso.



RELIEFS

UNITE

3 cores
colours
couleurs
colores

1 formato
format
formato

1 acabamento
finish
finition
acabado



Revestimentos com uma inspiração no natural e uma força delicada, para áreas interiores.

Natural inspiration and delicate strength brought by indoor ceramic wall tiles.

Revêtements à l'inspiration au naturel et une force délicate, pour les espaces intérieurs.

Revestimientos con una inspiración natural y una fuerza delicada, para espacios interiores.

39,4x118,6 cm
(16"x47")



RECT

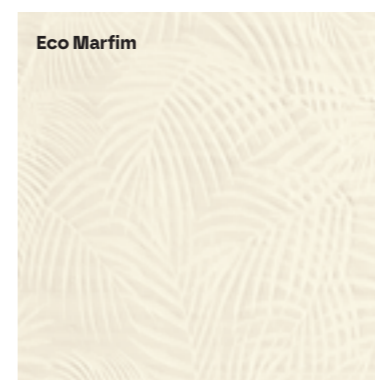
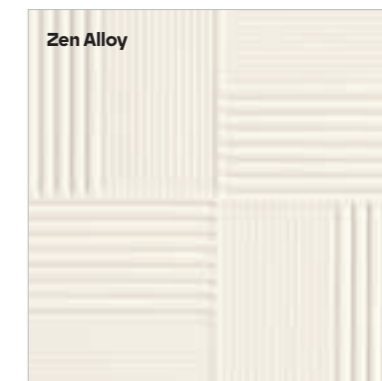



UNITE ZEN MARFIM _ LOCUS BONE



UNITE ZENFOG _ LOCUS SMOG

UNITE



UNITE ZEN MARFIM (*)

3101T97G11 39,4x118,6x1,23 cm RECT P99



UNITE ZEN ALLOY (*)

3101T97G01 39,4x118,6x1,23 cm RECT P99



UNITE ZEN SMOG (*)

3101T97G21 39,4x118,6x1,23 cm RECT P99

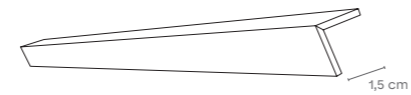

perfil
1,5x39,4x1,23 cm RECT P28 /peça_pieza

PERFIL: produzido de acordo com quantidades mínimas de 10 peças.
PERFIL: produced in minimum quantities of 10 pieces.
PERFIL: produites selon des quantités minimales de 10 pièces.
PERFIL: producidas en cantidades mínimas de 10 piezas.

(*) Dado o efeito deste produto, as peças devem ser aplicadas sempre no mesmo sentido, seguindo a orientação do tardo.
(*) Given the effect of the product, tiles must always be laid out facing same direction, following the orientation of the back.
(*) En raison de l'effet de ce produit, les carreaux doivent toujours être posés dans le même sens, en suivant l'orientation de sa face interne.
(*) Dado el efecto de este producto, las piezas deben aplicarse siempre en el mismo sentido, siguiendo la orientación del dorso.

UNITE



UNITE ECO MARFIM (*)

3101T97G41 39,4x118,6x1,23 cm RECT P99



UNITE ECO ALLOY (*)

3101T97G31 39,4x118,6x1,23 cm RECT P99



UNITE ECO SMOG (*)

3101T97G51 39,4x118,6x1,23 cm RECT P99





MARFIM MATE _ UNITE ECO MARFIM MATE _ OMNISTONE PLATINA



ECO BRONZE _ JINKO AMBAR _ CALACATTA ORO

UNITE

RELIEFS



ECO BRONZE (*) (e)

3301T9F851 39,4x118,6x1,23 cm RECT **P251 /peça_piece**



ECO GOLD (*) (e)

3301T9F861 39,4x118,6x1,23 cm RECT **P212 /peça_piece**



ECO SILVER (*) (e)

3301T9F871 39,4x118,6x1,23 cm RECT **P212 /peça_piece**



ECOPHILIA (*) (e)

3301T9F881 39,4x118,6x1,23 cm RECT **P135 /peça_piece**

UNITE



RELIEFS



(e) Dado o efeito de espelho deste produto, não devem ser utilizados utensílios ou produtos de limpeza ácidos ou abrasivos, os quais poderão danificar a decoração metálica.
 (e) Avoid using acid or abrasive cleaning products or utensils that may damage the metal finish and product mirror effect.
 (e) Pour préserver l'effet brillant miroir de ce produit, nous recommandons de ne pas utiliser la surface avec des instruments ou des nettoyeurs acides ou abrasifs car ils peuvent endommager l'aspect métal.
 (e) Debido al efecto espejo de este producto, no se deben utilizar utensilios ni productos de limpieza ácidos o abrasivos, ya que podrían dañar la decoración metálica.

PEÇAS · PIECES			CAIXA · BOX			EUROPALETE · EUROPALLET		
	≠		PZ	M ²	KG	CX	M ²	KG
39,4x118,6 cm	RECT	12,3 ±0,5 mm	3	1,40	29,00	18	25,20	543

(*) Dado o efeito deste produto, as peças devem ser aplicadas sempre no mesmo sentido, seguindo a orientação do dorso.
 (*) Given the effect of the product, tiles must always be laid out facing same direction, following the orientation of the back.
 (*) En raison de l'effet de ce produit, les carreaux doivent toujours être posés dans le même sens, en suivant l'orientation de sa face interne.
 (*) Dado el efecto de este producto, las piezas deben aplicarse siempre en el mismo sentido, siguiendo la orientación del dorso.



RELIEFS

NEUTRAL

3 cores
colours
couleurs
colores

2 formatos
formats
formats
formatos

1 acabamento
finish
finition
acabado



Revestimentos que promovem uma relação com a simplicidade.

Wall tiles that remind us of the simple things in life.

Des revêtements qui favorisent une relation avec la simplicité.

Revestimientos que favorecen una relación con la sencillez.

39,4x118,6 cm
(16"x47")

16,5x19 cm
(6"x7")

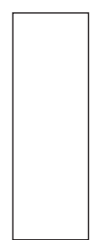

HEXAGONO



RECT



NEUTRAL

NEUTRAL



NEUTRAL MARFIM MATE

3101T96G81 39,4x118,6x1,23 cm RECT P99



NEUTRAL ALLOY MATE

3101T96G71 39,4x118,6x1,23 cm RECT P99



NEUTRAL SMOG MATE

3101T96G91 39,4x118,6x1,23 cm RECT P99

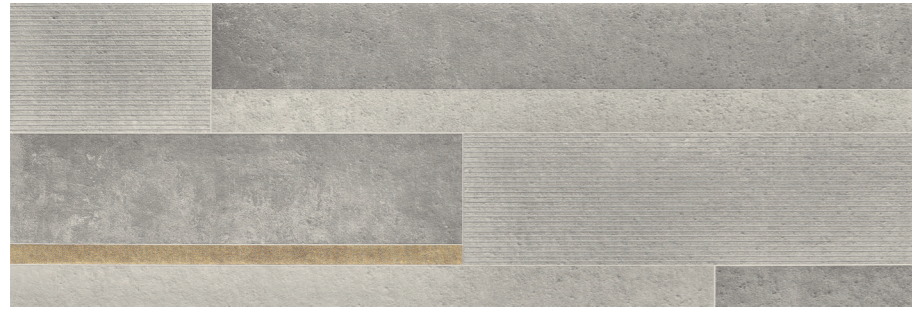

LUDO (b)

3301T9F731 39,4x118,6x1,23 cm RECT P175 /peça_piece



HEXAGONO NEUTRAL MARFIM MATE

3301V38G61 16,5x19x1,23 cm P261

[1m² = 41 peças_pieces]



HEXAGONO NEUTRAL ALLOY MATE

3101V36G71 16,5x19x1,23 cm P261

[1m² = 41 peças_pieces]



HEXAGONO NEUTRAL SMOG MATE

3301V38G71 16,5x19x1,23 cm P261

[1m² = 41 peças_pieces]



TWIST BEGE

3301V3F671 16,5x19x1,23 cm P15 /peça_piece

[1m² = 41 peças_pieces]



TWIST GRIS

3301V3F681 16,5x19x1,23 cm P15 /peça_piece

[1m² = 41 peças_pieces]

(b) Existem 2 peças diferentes, de acordo com o desenho do decorado, que devem ser aplicadas alternadamente, de modo a obter-se uma solução mais rica e variada.
 (b) There are 2 different pieces, matching the design of the decorated tiles, which should be applied alternately in order to obtain a richer and more varied decoration.
 (b) 2 différentes pièces correspondent au dessin du décor. Il convient de les appliquer de façon alternée pour obtenir une disposition plus riche et plus variée.
 (b) Existen 2 piezas diferentes, de acuerdo con el diseño del decorado, que deben aplicarse de forma alterna, con el fin de obtener una solución más y variada.

PEÇAS · PIECES			CAIXA · BOX			EUROPALETE · EUROPALLET		
		±	PZ	M ²	KG	CX	M ²	KG
39,4x118,6 cm	RECT	12,3 ±0,5 mm	3	1,40	29,00	18	25,20	543

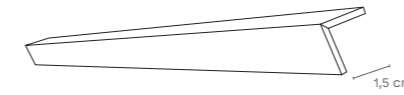

perfil
1,5x39,4x1,23 cm RECT P28 /peça_piece

PERFIL: produzido de acordo com quantidades mínimas de 10 peças.
 PERFIL: produced in minimum quantities of 10 pieces.
 PERFIL: produites selon des quantités minimales de 10 pièces.
 PERFIL: producidas en cantidades mínimas de 10 piezas.



NEUTRAL ALLOY MATE _ HEXAGONO NEUTRAL ALLOY MATE _ HEXAGONO NEUTRAL SMOG MATE _ TWIST GRIS _ LOCUS SMOG _ ODIN WHITE



BOLD MOSS MATE _ FLICK BRANCO MATE _ LOCUS ALLOY _ QUILT GREEN

RELIEFS

BOLD _ FLICK



7 cores / colours / couleurs / colores 1 formato / format / formato 1 acabamento / finish / finition / acabado

Revestimentos cerâmicos que contribuem para a expressividade dos espaços vividos.

Ceramic wall tiles that help build the expressivity of living spaces.

Des revêtements céramiques qui contribuent à l'expressivité des espaces vécus.

Revestimientos cerámicos que contribuyen a la expresividad de los espacios vividos.

29,5x88,9 cm
(12"x35")



RECT

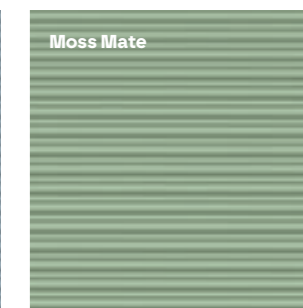
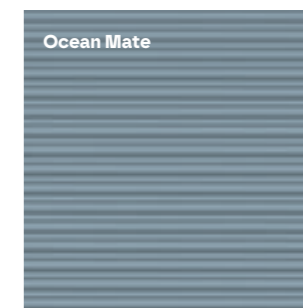
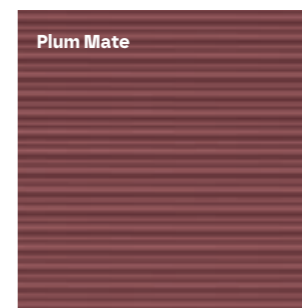
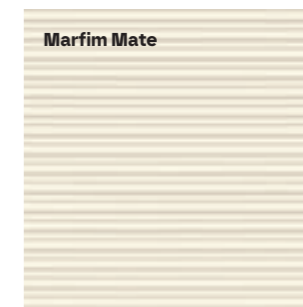
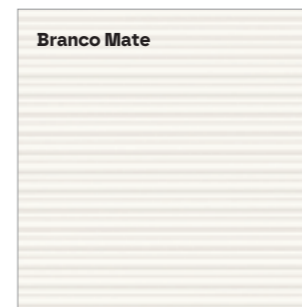

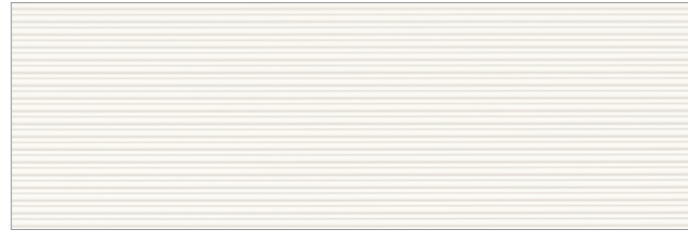

FLICK BRANCO MATE (*)

3101G8G11 29,5x88,9x1,23 cm RECT **P88**



FLICK MARFIM MATE (*)

3101G85G11 29,5x88,9x1,23 cm RECT **P88**



FLICK SMOG MATE (*)

3101G85G21 29,5x88,9x1,23 cm RECT **P88**



BOLD OCEAN MATE (*)

3101G85G91 29,5x88,9x1,23 cm RECT **P94**



BOLD MOSS MATE (*)

3101G85G81 29,5x88,9x1,23 cm RECT **P94**

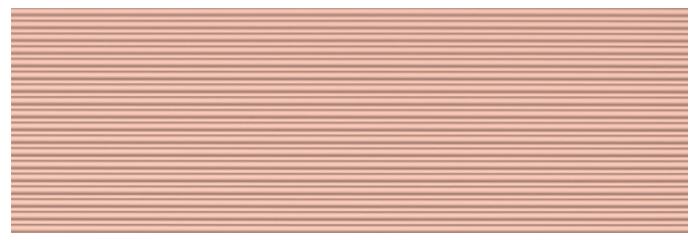

BOLD PINKY MATE (*)

3101G86G01 29,5x88,9x1,23 cm RECT **P94**



BOLD PLUM MATE (*)

3101G86G11 29,5x88,9x1,23 cm RECT **P102**

PEÇAS · PIECES			CAIXA · BOX			EUROPALETE · EUROPALLET		
		±	PZ	M²	KG	CX	M²	KG
29,5x88,9 cm	RECT	12,3 ±0,5 mm	4	1,05	22,00	40	42,00	901

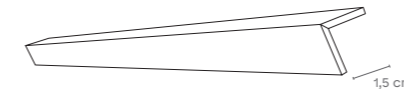

perfil

1,5x29,5x1,23 cm RECT **P20 /peça_pieza**

PERFIL: produzido de acordo com quantidades mínimas de 10 peças.
 PERFIL: produced in minimum quantities of 10 pieces.
 PERFIL: produites selon des quantités minimales de 10 pièces.
 PERFIL: producidas en cantidades mínimas de 10 piezas.



BOLD OCEAN MATE



FLICK SMOG MATE

(*) Dado o efeito deste produto, as peças devem ser aplicadas sempre no mesmo sentido, seguindo a orientação do tardo.
 (*) Given the effect of the product, tiles must always be laid out facing same direction, following the orientation of the back.
 (*) En raison de l'effet de ce produit, les carreaux doivent toujours être posés dans le même sens, en suivant l'orientation de sa face interne.
 (*) Dado el efecto de este producto, las piezas deben aplicarse siempre en el mismo sentido, siguiendo la orientación del dorso.



RELIEFS

MIX RELIEFS



- 1 cor
colour
couleur
color
- 2 formatos
formats
formats
- 2 acabamentos
finishes
finitions
acabados

Uma mistura de linhas, volumes e texturas, com jogos de luz e sombras, que cria movimento e dá vida própria aos ambientes.

A mix of lines, volumes and textures, with play of light and shadow, creating movement and bringing environments to life.

Un mélange de lignes, de volumes et de textures, avec des jeux d'ombres et de lumières, qui crée du mouvement et donne vie aux ambiances.

Una mezcla de líneas, volúmenes y texturas, con juegos de luz y sombras, que crea movimiento y da vida propia a los ambientes.

29,5x88,9 cm
(12"x35")

29,5x59,2 cm
(12"x23")



RECT

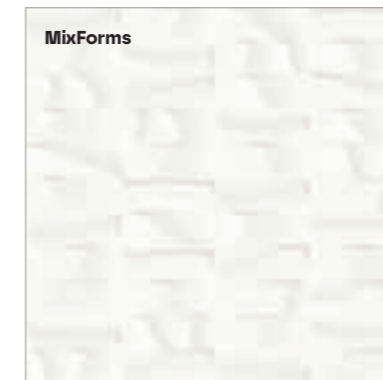

MIX RELIEFS

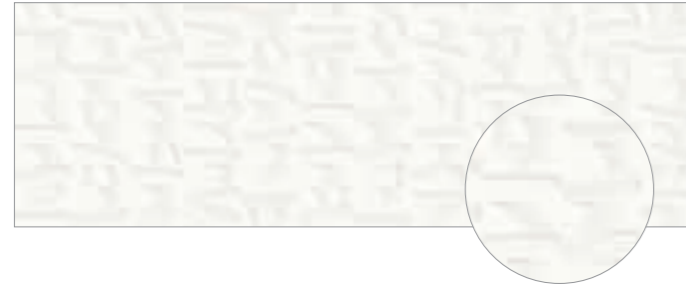

MIXFORMS WHITE (*)

3101G8G961	29,5x88,9x1,23 cm	RECT	P88
------------	-------------------	------	-----



MIXPEAK WHITE (*)

3101G8G971	29,5x88,9x1,23 cm	RECT	P88
310121G971	29,5x59,2x0,90 cm	RECT	P80



MIXSTEP WHITE (*)

3101210G71	29,5x59,2x0,90 cm	RECT	P80
------------	-------------------	------	-----



PERFIL MIXSPET WITH



MIXSPET WITH

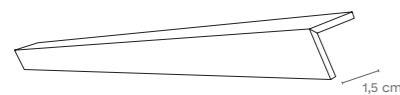

perfil			
1,5x29,5x0,90 cm	RECT	P20 /peça_pieza	
1,5x59,2x0,90 cm	RECT	P32 /peça_pieza	

PERFIL: produzido de acordo com quantidades mínimas de 10 peças.
 PERFIL: produced in minimum quantities of 10 pieces.
 PERFIL: produites selon des quantités minimales de 10 pièces.
 PERFIL: producidas en cantidades mínimas de 10 piezas.

(*) Dado o efeito deste produto, as peças devem ser aplicadas sempre no mesmo sentido, seguindo a orientação do tardo.
 (*) Given the effect of the product, tiles must always be laid out facing same direction, following the orientation of the back.
 (*) En raison de l'effet de ce produit, les carreaux doivent toujours être posés dans le même sens, en suivant l'orientation de sa face interne.
 (*) Dado el efecto de este producto, las piezas deben aplicarse siempre en el mismo sentido, siguiendo la orientación del dorso.

MIX RELIEFS



PEÇAS · PIECES			CAIXA · BOX			EUROPALETE · EUROPALLET		
		±	PZ	M²	KG	CX	M²	KG
29,5x59,2 cm	RECT	9,0% ±0,5 mm	8	1,40	23,20	32	44,80	763
29,5x88,9 cm	RECT	12,3 ±0,5 mm	4	1,05	22,00	40	42,00	901



BRANCO MATE _ MIXPEAK WHITE



CONCRETE

NEW FORMAT	LIGHT XL	Rule	170
		Locus _ Quilt	178
	NEW FORMAT	Cityzen	188
		Elements	196
NEW	TECH	20mm	
		Urban _ Hydraulik	204
		Silken	214



CONCRETE

RULE

2 cores colours couleurs colores 7 formatos formats formats formatos 3 acabamentos finishes finitions acabados



Traços despretensiosos com o efeito do cimento, para revestimento e pavimento, em interiores e exteriores.

Unpretentious strokes with the cement effect of ceramic wall and floor tiles for indoor and outdoor use.

Traits non prétentieux à l'effet ciment, pour les revêtements de mur et de sol, à l'intérieur et à l'extérieur.

Trazos sin pretensiones con el efecto del cemento, para revestimientos y pavimentos, en interiores y exteriores.



SOFT GRIP · SILK · RECT

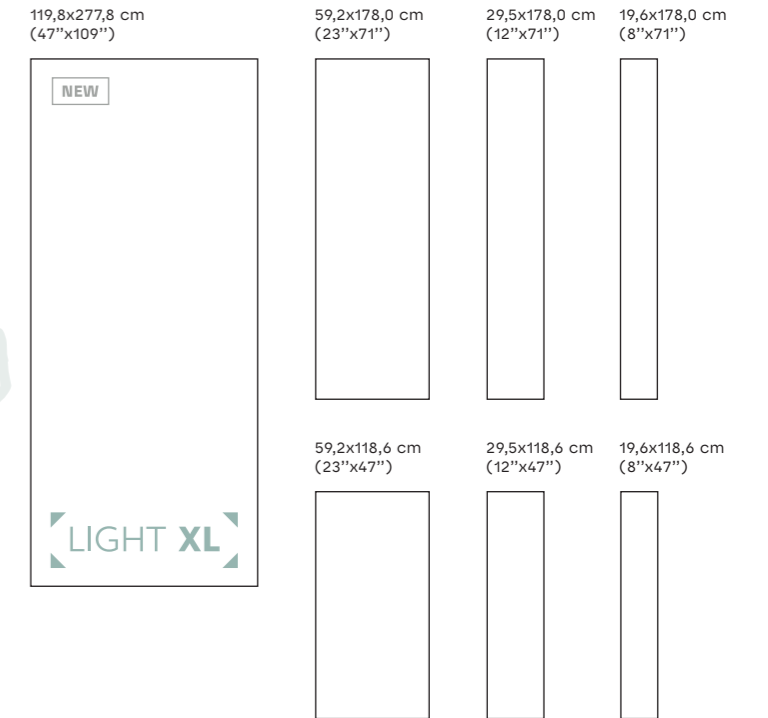

6
Até 6 desenhos
Up to 6 designs
Jusqu'à 6 dessins
Hasta 6 diseños

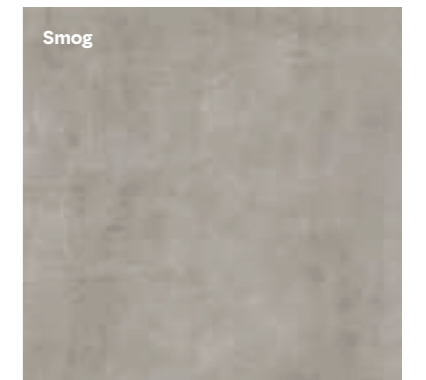
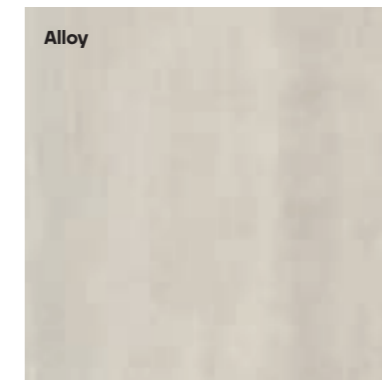

RULE

LIGHT XL



RULE ALLOY

3021X4V711	119,8x277,8x0,60 cm	RECT	P145
------------	---------------------	------	------

Até 3 desenhos
Up to 3 designs
Jusqu'à 3 dessins
Hasta 3 diseños

GRAPHIC VARIATION



RULE

LIGHT XL



RULE SMOG

3021X4V721	119,8x277,8x0,60 cm	RECT	P145
------------	---------------------	------	------

Até 3 desenhos
Up to 3 designs
Jusqu'à 3 dessins
Hasta 3 diseños

GRAPHIC VARIATION



Tendo em vista alcançar um efeito global mais real e harmonioso, são produzidas peças diferentes umas das outras com variações de desenho e/ou cores entre elas.
For a more genuine and harmonious effect overall, different tiles with design and/or colour variations are produced.
Afin d'obtenir un effet global plus réel et harmonieux, nos pièces sont différentes les unes des autres avec des variations de dessin et / ou de nuances entre elles.
Para lograr un efecto global más real y armonioso, se producen piezas diferentes unas de otras con variaciones de diseño y/o color.

Para o assentamento de peças de grande formato, sugerimos a utilização de niveladores para ajudar a posicionar e nivelar peças.
When laying large format tiles, use levelling spacers to ensure proper installing and levelling of tiles.

Pour la pose de pièces de grand format, nous suggérons l'utilisation de croisillons autonivelants pour aider à positionner et à niveler les pièces.
Para la colocación de piezas de gran tamaño, sugerimos utilizar niveladores para ayudar a colocar y nivelar piezas.

LIGHT XL é ideal para renovações, sem demolições. Este grande formato de espessura fina garante a qualidade técnica do grés porcelânico aliada ao efeito estético apresentado.
LIGHT XL is perfect for renovation without demolition. This large, thin format guarantees the technical quality of porcelain tiles combined with the aesthetic effect described above.
LIGHT XL est idéal pour les rénovations, sans démolition. Ce grand format de faible épaisseur garantit la qualité technique du grés cérame combinée à l'effet esthétique présenté.
LIGHT XL es ideal para renovaciones, sin demoliciones. Este gran formato, con espesor fino, garantiza la calidad técnica del gres porcelánico aliado al efecto estético que presenta.

Fornecido em caixa de madeira: preço sob consulta.
Delivered in a wooden box: price on request.

Fourniture dans un boitage bois : prix sur demande.
Se entrega en una caja de madera: precio bajo presupuesto.



CONCRETE



CONCRETE



RULE ALLOY

3121L8V711	19,6x118,6x1,05 cm	SOFT GRIP	P101
312GL8V711	19,6x118,6x1,05 cm	SILK	P101
312FD6V711	29,5x118,6x1,05 cm	SOFT GRIP	P101
312GD6V711	29,5x118,6x1,05 cm	SILK	P101
312FD3V711	59,2x118,6x1,05 cm	SOFT GRIP	P101
312GD3V711	59,2x118,6x1,05 cm	SILK	P101
312FS8V711	19,6x178,0x1,12 cm	SOFT GRIP	P123
312GS8V711	19,6x178,0x1,12 cm	SILK	P123
312FS7V711	29,5x178,0x1,12 cm	SOFT GRIP	P123
312GS7V711	29,5x178,0x1,12 cm	SILK	P123
312FS5V711	59,2x178,0x1,12 cm	SOFT GRIP	P123
312GS5V711	59,2x178,0x1,12 cm	SILK	P123

RULE SMOG

312FL8V721	19,6x118,6x1,05 cm	SOFT GRIP	P101
312GL8V721	19,6x118,6x1,05 cm	SILK	P101
312FD6V721	29,5x118,6x1,05 cm	SOFT GRIP	P101
312GD6V721	29,5x118,6x1,05 cm	SILK	P101
312FD3V721	59,2x118,6x1,05 cm	SOFT GRIP	P101
312GD3V721	59,2x118,6x1,05 cm	SILK	P101
312FS8V721	19,6x178,0x1,12 cm	SOFT GRIP	P123
312GS8V721	19,6x178,0x1,12 cm	SILK	P123
312FS7V721	29,5x178,0x1,12 cm	SOFT GRIP	P123
312GS7V721	29,5x178,0x1,12 cm	SILK	P123
312FS5V721	59,2x178,0x1,12 cm	SOFT GRIP	P123
312GS5V721	59,2x178,0x1,12 cm	SILK	P123



PEÇAS · PIECES	T	CAIXA · BOX			EUROPALETE · EUROPALLET			
		PZ	M²	KG	CX	M²	KG	
19,6x118,6 cm	SOFT GRIP · SILK	10,5 ±5mm	6	1.39	33.0	22	30.58	747
29,5x118,6 cm	SOFT GRIP · SILK	10,5 ±5mm	4	1.40	33.0	16	22.4	549
59,2x118,6 cm	SOFT GRIP · SILK	10,5 ±5mm	2	1.40	33.0	30	42.00	1 011
19,6x178,0 cm	SOFT GRIP · SILK	11,2 ±5mm	4	1.40	35.5	32	44.80	1 162
29,5x178,0 cm	SOFT GRIP · SILK	11,2 ±5mm	3	1.58	41.1	20	31.60	848
59,2x178,0 cm	SOFT GRIP · SILK	11,2 ±5mm	1	1.05	28.5	42	44.10	1 222
119,8x277,8 cm	RECT	6,0 ±5%	1	3.33	50.4	18	59.94	1 019

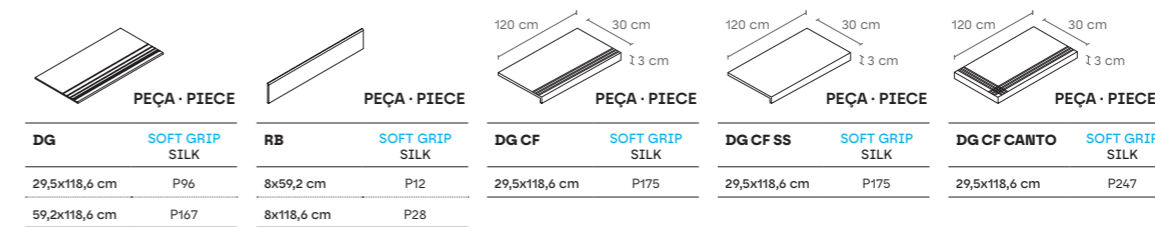

DG CF / DG CF Canto/DG CF SS: Peças produzidas sob encomenda. Altura do focinho: entre 3 cm e 10 cm. Indicar a altura pretendida no ato da encomenda.

DG CF / DG CF Canto/DG CF SS: Pieces produced on order. Trim height: 3 to 10 cm. Specify desired height when placing a order.

DG CF / DG CF Canto/DG CF SS: Pièces produites sur commande. Hauteur du nez de marche : entre 3 cm et 10 cm. Préciser la hauteur souhaitée lors de la commande.

DG CF / DG CF Canto/DG CF SS: Piezas producidas por encargo. Altura del ángulo: entre 3 y 10 cm. Indicar la altura deseada al realizar el pedido.

DG CF Canto: Disponível em canto esquerdo e direito.

DG CF Canto: Available in left and right corner.

DG CF Canto: Disponible en angle gauche et droit.

DG CF Canto: Canto izquierdo y derecho disponibles.

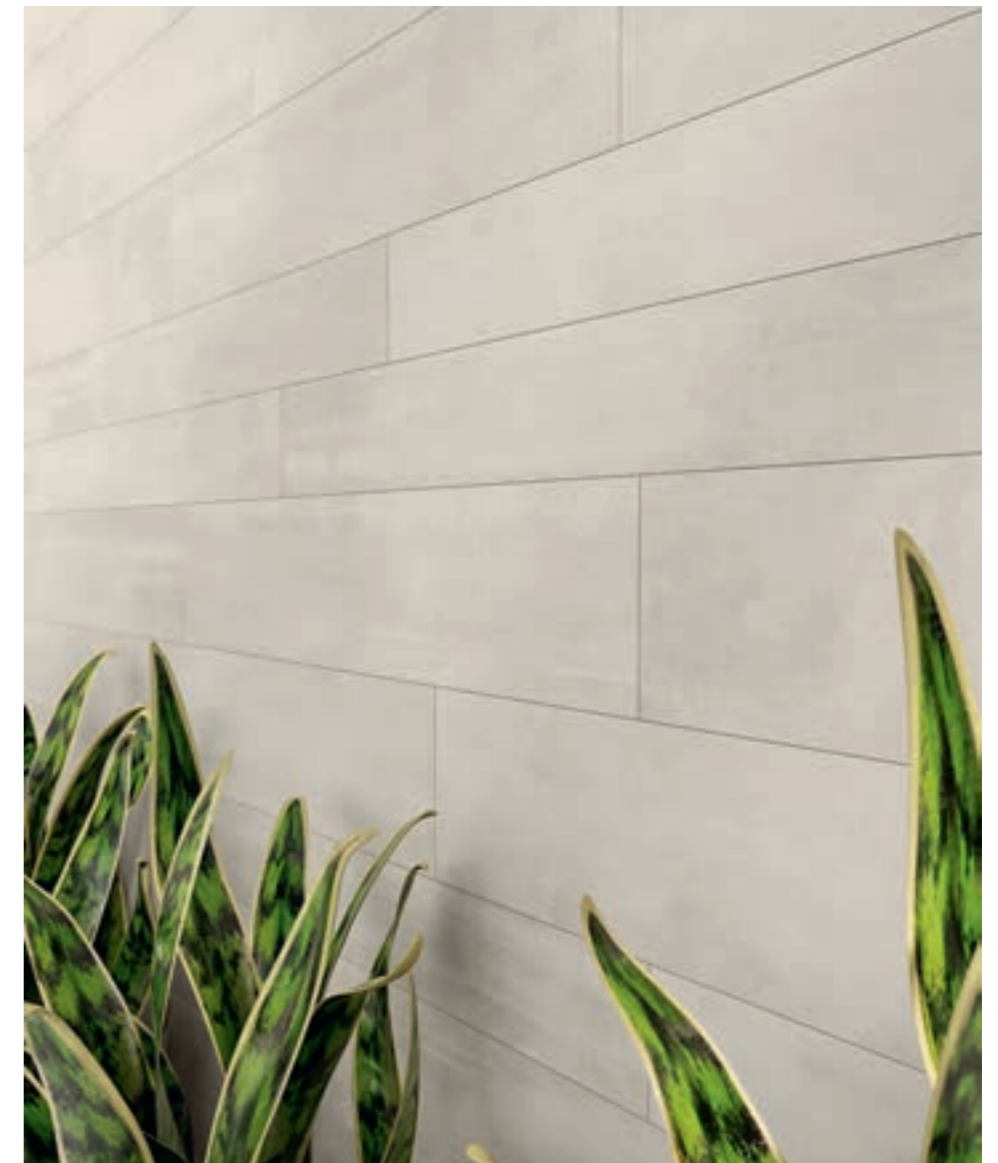

19,6x118,6 · 29,5x118,6 · 59,2x118,6 · 19,6x178,0 · 29,5x178,0 · 59,2x178,0 cm	SOFT GRIP	V3	5	class 2	B	R11	36+	≥0,42	U4P3E3C2
19,6x118,6 · 29,5x118,6 · 59,2x118,6 · 19,6x178,0 · 29,5x178,0 · 59,2x178,0 cm	SILK	V3	5	class 1	A	R9	-	≥0,42	U4P3E3C2

Produtos que integram alguns materiais reciclados.
 Products that incorporate some recycled materials.
 Produits intégrant quelques matériaux recyclés.
 Productos que incorporan algunos materiales reciclados.

SOFT GRIP: Produtos que minimizam o risco de deslizamento.
 SOFT GRIP: Products that minimize the risk of slipping.
 SOFT GRIP: Produits qui réduisent le risque de glissement.
 SOFT GRIP: Productos que minimizan el riesgo de deslizamiento.

Para o assentamento de peças de grande formato, sugerimos a utilização de niveladores para ajudar a posicionar e nivelar a junta entre peças. Estes acessórios plásticos devem ser utilizados após a aplicação da cola.
 When laying large format tiles, use levelling spacers to ensure proper installing and levelling of tiles. Use the plastic spacers after the adhesive has been applied.
 Pour la pose de pièces de grand format, nous suggérons l'utilisation de croisillons autonivelants pour aider à positionner et à niveler le joint entre les pièces. Ces accessoires en plastique doivent être utilisés après l'application de la colle.
 Para la colocación de piezas de gran tamaño, sugerimos utilizar niveladores para ayudar a colocar y nivelar la junta entre piezas. Estos accesorios plásticos deben utilizarse una vez aplicada la cola.



CONCRETE

LOCUS _ QUILT



7 cores / colours / couleurs / colores | 7 formatos / formats / formats / formatos | 2 acabamentos / finishes / finitions / acabados

Vigor sereno envolto de elegância intemporal para revestimento e pavimento, em interiores e exteriores.

Peaceful vigour surrounded by timeless elegance of ceramic wall and floor tiles for indoor and outdoor use.

Vigueur sereine enrobée d'une élégance intemporelle pour les revêtements de mur et de sol intérieurs et extérieurs.

Vigor sereno envuelto en una elegancia atemporal para revestimientos y pavimentos, en interiores y exteriores.

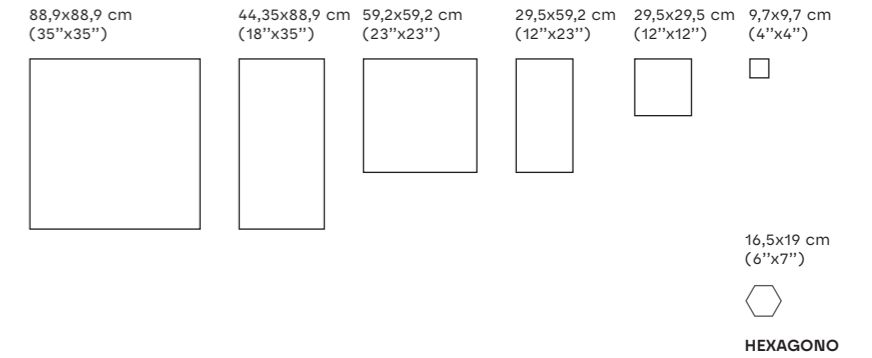

SOFT GRIP · SILK

16
Até 16 desenhos
Up to 16 designs
Jusqu'à 16 dessins
Hasta 16 diseños

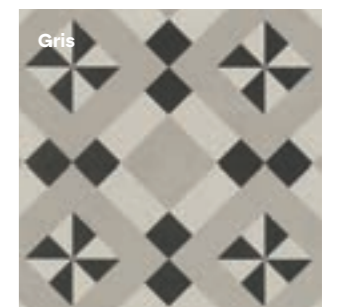
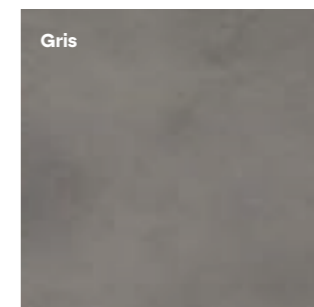
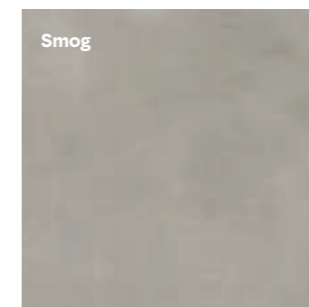

LOCUS



CONCRETE

CONCRETE

180

revigres

LOCUS SMOG _ LOCUS GRIS _ LOCUS ALLOY

181

revigres



LOCUS BONE

312F08V681	9,7x9,7x0,85 cm	SOFT GRIP	P108
312G08V681	9,7x9,7x0,85 cm	SILK	P108
312F21V681	29,5x59,2x0,85 cm	SOFT GRIP	P87
312G21V681	29,5x59,2x0,85 cm	SILK	P87
312F13V681	59,2x59,2x0,85 cm	SOFT GRIP	P87
312G13V681	59,2x59,2x0,85 cm	SILK	P87
312FH8V681	44,35x88,9x1,05 cm	SOFT GRIP	P91
312GH8V681	44,35x88,9x1,05 cm	SILK	P91
312FK7V681	88,9x88,9x1,05 cm	SOFT GRIP	P101
312GK7V681	88,9x88,9x1,05 cm	SILK	P101

HEXAGON LOCUS BONE

332FV3V771	16,5x19x0,85 cm	SOFT GRIP	P293
332GV3V771	16,5x19x0,85 cm	SILK	P293



LOCUS ALLOY

312F08V671	9,7x9,7x0,85 cm	SOFT GRIP	P108
312G08V671	9,7x9,7x0,85 cm	SILK	P108
312F21V671	29,5x59,2x0,85 cm	SOFT GRIP	P87
312G21V671	29,5x59,2x0,85 cm	SILK	P87
312F13V671	59,2x59,2x0,85 cm	SOFT GRIP	P87
312G13V671	59,2x59,2x0,85 cm	SILK	P87
312FH8V671	44,35x88,9x1,05 cm	SOFT GRIP	P91
312GH8V671	44,35x88,9x1,05 cm	SILK	P91
312FK7V671	88,9x88,9x1,05 cm	SOFT GRIP	P101
312GK7V671	88,9x88,9x1,05 cm	SILK	P101

HEXAGON LOCUS ALLOY

332FV3V761	16,5x19x0,85 cm	SOFT GRIP	P293
332GV3V761	16,5x19x0,85 cm	SILK	P293



LOCUS SMOG

312F08V701	9,7x9,7x0,85 cm	SOFT GRIP	P108
312G08V701	9,7x9,7x0,85 cm	SILK	P108
312F21V701	29,5x59,2x0,85 cm	SOFT GRIP	P87
312G21V701	29,5x59,2x0,85 cm	SILK	P87
312F13V701	59,2x59,2x0,85 cm	SOFT GRIP	P87
312G13V701	59,2x59,2x0,85 cm	SILK	P87
312FH8V701	44,35x88,9x1,05 cm	SOFT GRIP	P91
312GH8V701	44,35x88,9x1,05 cm	SILK	P91
312FK7V701	88,9x88,9x1,05 cm	SOFT GRIP	P101
312GK7V701	88,9x88,9x1,05 cm	SILK	P101

HEXAGON LOCUS SMOG

332FV3V791	16,5x19x0,85 cm	SOFT GRIP	P293
332GV3V791	16,5x19x0,85 cm	SILK	P293



LOCUS GRIS

312F08V691	9,7x9,7x0,85 cm	SOFT GRIP	P108
312G08V691	9,7x9,7x0,85 cm	SILK	P108
312F21V691	29,5x59,2x0,85 cm	SOFT GRIP	P87
312G21V691	29,5x59,2x0,85 cm	SILK	P87
312F13V691	59,2x59,2x0,85 cm	SOFT GRIP	P87
312G13V691	59,2x59,2x0,85 cm	SILK	P87
312FH8V691	44,35x88,9x1,05 cm	SOFT GRIP	P91
312GH8V691	44,35x88,9x1,05 cm	SILK	P91
312FK7V691	88,9x88,9x1,05 cm	SOFT GRIP	P101
312GK7V691	88,9x88,9x1,05 cm	SILK	P101

HEXAGON LOCUS GRIS

332FV3V781	16,5x19x0,85 cm	SOFT GRIP	P293
332GV3V781	16,5x19x0,85 cm	SILK	P293



HEXAGONO

[1m² = 41 peças/pieces]



Produtos que integram alguns materiais reciclados.
Products that incorporate some recycled materials.
Produits intégrant quelques matériaux recyclés.
Productos que incorporan algunos materiales reciclados.

SOFT GRIP: Produtos que minimizam o risco de deslizamento.
SOFT GRIP: Products that minimize the risk of slipping.
SOFT GRIP: Produits qui réduisent le risque de glissement.
SOFT GRIP: Productos que minimizan el riesgo de deslizamiento.

LINEA 2	LINEA 4	LINEA 8
29,5x59,2	29,5x59,2	29,5x59,2

Pág. 44



29,5x59,2 · 59,2x59,2 · 44,35x88,9 · 88,9x88,9 cm	SOFT GRIP	V3	5	class 2	B	R11	36+	≥0,42	-
29,5x59,2 · 44,35x88,9 · 88,9x88,9 cm	SILK	V3	5	class 1	A	R9	-	≥0,42	U4P3E3C2
59,2x59,2 cm	SILK	V3	5	class 1	A	R9	-	≥0,42	U4P4E3C2

QUILT



QUILT BONE

312F12V641	29,5x29,5x0,85 cm	SOFT GRIP	P87
312G12V641	29,5x29,5x0,85 cm	SILK	P87



QUILT GRIS

312F12V651	29,5x29,5x0,85 cm	SOFT GRIP	P87
312G12V651	29,5x29,5x0,85 cm	SILK	P87



QUILT GREEN

312F12V661	29,5x29,5x0,85 cm	SOFT GRIP	P87
312G12V661	29,5x29,5x0,85 cm	SILK	P87

QUILT GRIS



QUILT



CONCRETE

CONCRETE

SOFT GRIP: Produtos que minimizam o risco de deslizamento.
SOFT GRIP: Products that minimize the risk of slipping.
SOFT GRIP: Produits qui réduisent le risque de glissement.
SOFT GRIP: Productos que minimizan el riesgo de deslizamiento.



29,5x59,2 cm	SOFT GRIP	V3	5	class 2	B	R11	36+	≥0,42	U4P4+E3C2
29,5x59,2 cm	SILK	V3	5	class 1	A	R9	-	≥0,42	U4P4+E3C2



STRATUS 9 LOCUS MIX BRICK (a) (f)

Bases: Locus Alloy + Locus Gris + Cromática Brick
 312G1250X1 29,5x29,5x0,85 cm SILK P19 /peça_pieza
 [1m² = 11 peças_pieces]



STRATUS 9 LOCUS MIX COBALTO (a) (f)

Bases: Locus Alloy + Locus Smog + Cromática Cobalto
 312G1251X1 29,5x29,5x0,85 cm SILK P19 /peça_pieza
 [1m² = 11 peças_pieces]

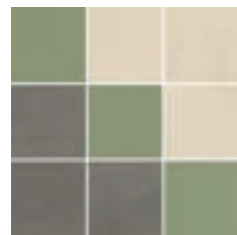

STRATUS 9 LOCUS MIX OLIVA (a) (f)

Bases: Locus Bone + Locus Gris + Cromática Oliva
 312G1253X1 29,5x29,5x0,85 cm SILK P19 /peça_pieza
 [1m² = 11 peças_pieces]



STRATUS 9 LOCUS MIX OCRE (a) (f)

Bases: Locus Bone + Locus Gris + Cromática Ocre
 312G1252X1 29,5x29,5x0,85 cm SILK P19 /peça_pieza
 [1m² = 11 peças_pieces]



HEXA FLOW BONE (b) (f)

332FV3F721 16,5x19x0,85 cm SOFT GRIP P15 /peça_pieza
 [1m² = 41 peças_pieces]



HEXA FLOW SMOG (b) (f)

332FV3F711 16,5x19x0,85 cm SOFT GRIP P15 /peça_pieza
 [1m² = 41 peças_pieces]



HEXA SHADOW GRIS (c) (f)

332FV3F701 16,5x19x0,85 cm SOFT GRIP P14 /peça_pieza
 [1m² = 41 peças_pieces]



HEXA FLOW SMOG



PEÇAS · PIECES	CAIXA · BOX	EUROPALETE · EUROPALLET		
		PZ	M ²	KG
9,7x9,7 cm	SOFT GRIP · SILK 8,5 ±5%	32	0.30	5.80
16,5x19 cm	SOFT GRIP · SILK 8,5 ±5%	6	0.15	3.50
29,5x29,5 cm	SOFT GRIP · SILK 8,5 ±5%	16	1.39	28.8
29,5x59,2 cm	SOFT GRIP · SILK 8,5 ±5%	8	1.40	28.8
59,2x59,2 cm	SOFT GRIP · SILK 8,5 ±5%	4	1.40	28.7
44,35x88,9 cm	SOFT GRIP · SILK 10,5 ±0,5mm	4	1.58	39.0
88,9x88,9 cm	SOFT GRIP · SILK 10,5 ±0,5mm	2	1.58	39.0

PEÇA · PIECE		PEÇA · PIECE		PEÇA · PIECE		PEÇA · PIECE		PEÇA · PIECE	
DG	SOFT GRIP SILK	RB	SOFT GRIP SILK	DG CF	SOFT GRIP SILK	DG CF SS	SOFT GRIP SILK	DG CF CANTO	SOFT GRIP SILK
29,5x59,2 cm	P18	9,5x29,5 cm	P08	29,5x59,2 cm	P157	29,5x59,2 cm	P157	29,5x59,2 cm	P207
59,2x59,2 cm	P36	8x44,35 cm	P16						
44,35x88,9 cm	P96	8x59,2 cm	P12						
		8x88,9 cm	P28						

DG CF / DG CF Canto/DG CF SS: Peças produzidas sob encomenda. Altura do flocinho: entre 3 cm e 10 cm. Indicar a altura pretendida no ato da encomenda.
 DG CF / DG CF Canto/DG CF SS: Pièces produites sur commande. Hauteur du nez de marche : entre 3 cm et 10 cm. Préciser la hauteur souhaitée lors de la commande.
 DG CF / DG CF Canto/DG CF SS: Piezas producidas por encargo. Altura del ángulo: entre 3 y 10 cm. Indicar la altura deseada al realizar el pedido.

DG CF Canto: Disponível em canto esquerdo e direito.
 DG CF Canto: Available in left and right corner.
 DG CF Canto: Disponible en angle gauche et droit.
 DG CF Canto: Canto izquierdo y derecho disponibles.

GRAPHIC VARIATION

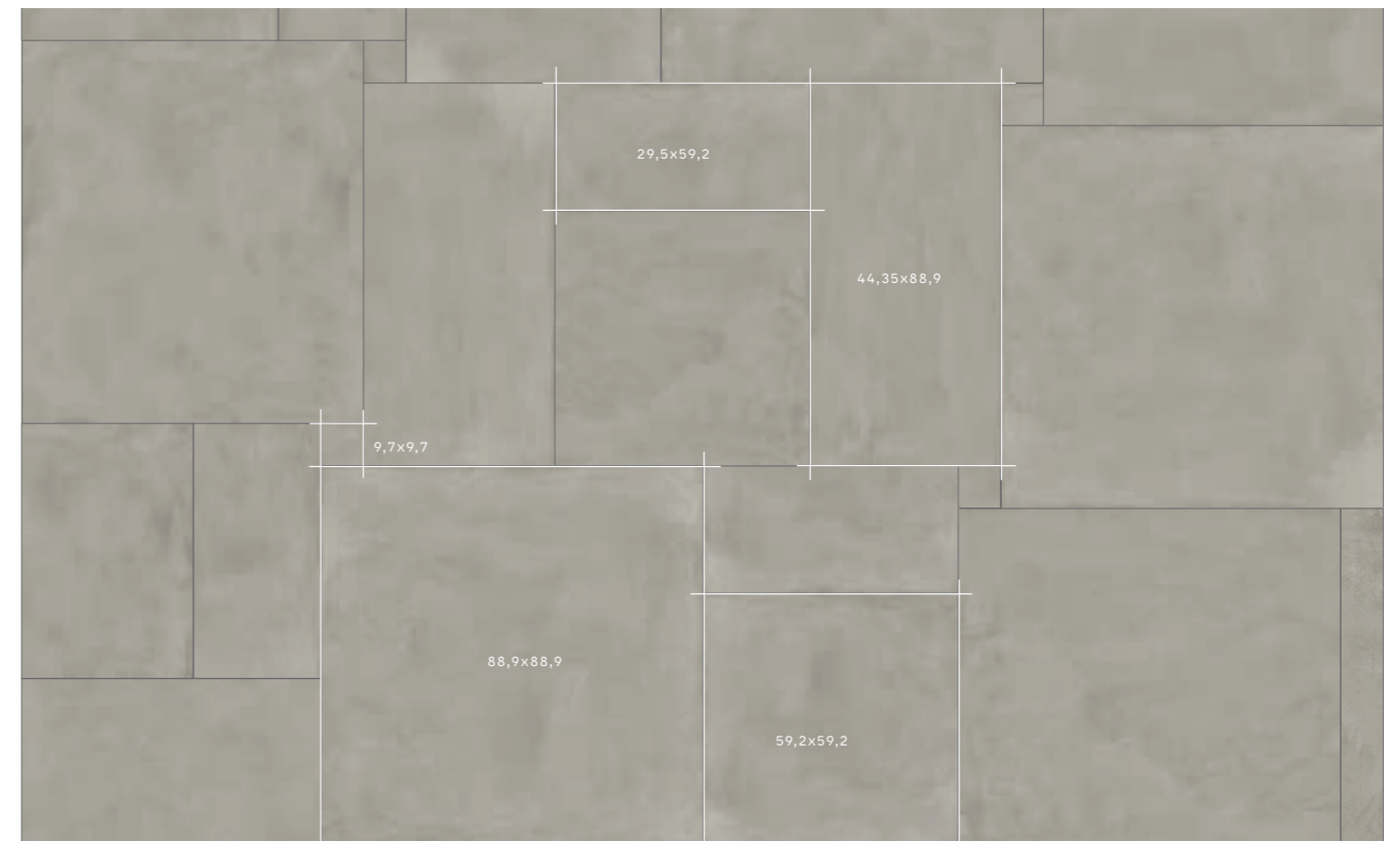

(b) Existem 9 peças diferentes, de acordo com o desenho do decorado, que devem ser aplicadas alternadamente, de modo a obter-se uma solução mais rica e variada.
 (b) There are 9 pieces, matching the design of the decorated tiles, which should be applied alternately in order to obtain a richer and more varied decoration.
 (b) Différentes 9 pièces correspondent au dessin du décor. Il convient de les appliquer de façon alternée pour obtenir une disposition plus riche et plus variée.
 (b) Existen 9 piezas diferentes, de acuerdo con el diseño del decorado, que deben aplicarse de forma alterna, con el fin de obtener una solución más y variada.

(c) Existem 18 peças diferentes, de acordo com o desenho do decorado, que devem ser aplicadas alternadamente, de modo a obter-se uma solução mais rica e variada.
 (c) There are 18 pieces, matching the design of the decorated tiles, which should be applied alternately in order to obtain a richer and more varied decoration.
 (c) Différentes 18 pièces correspondent au dessin du décor. Il convient de les appliquer de façon alternée pour obtenir une disposition plus riche et plus variée.
 (c) Existen 18 piezas diferentes, de acuerdo con el diseño del decorado, que deben aplicarse de forma alterna, con el fin de obtener una solución más y variada.



CITYZEN GRIS _ REFLEX CORTEN

CONCRETE

CITYZEN

5 cores / colours / couleurs / colores
 6 formatos / formats / formats / formatos
 2 acabamentos / finishes / finitions / acabados



A sutileza orgânica do cimento, enriquecida com tonalidades e texturas, promove a serenidade em ambientes citadinos.

The organic subtleness of cement, enriched with shades and textures, caters for serenity in city environments.

La subtilité organique du ciment, enrichie des tonalités et des textures, promeuve la sérénité dans les ambiances citadines.

La sutileza orgánica del cemento enriquecida con tonos y texturas que fomentan la serenidad en ambientes urbanos.



MATT RECT · ANTISLIP RECT

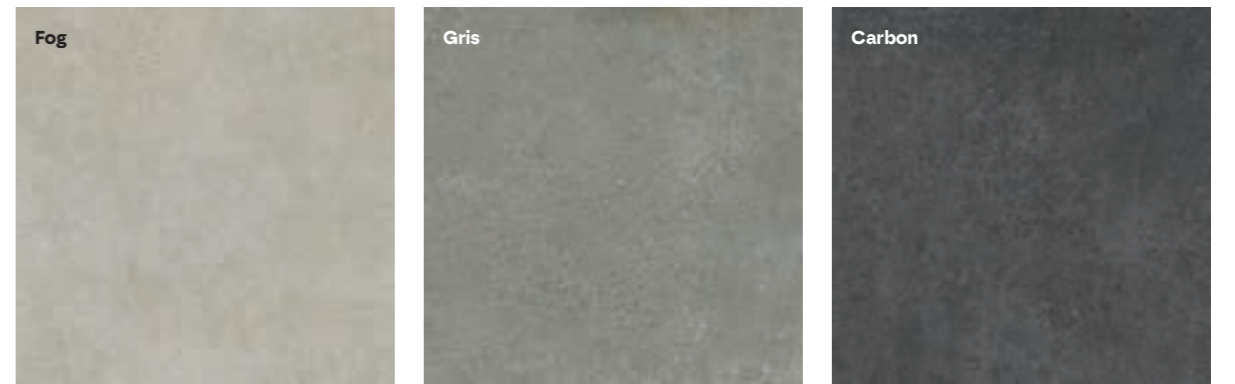
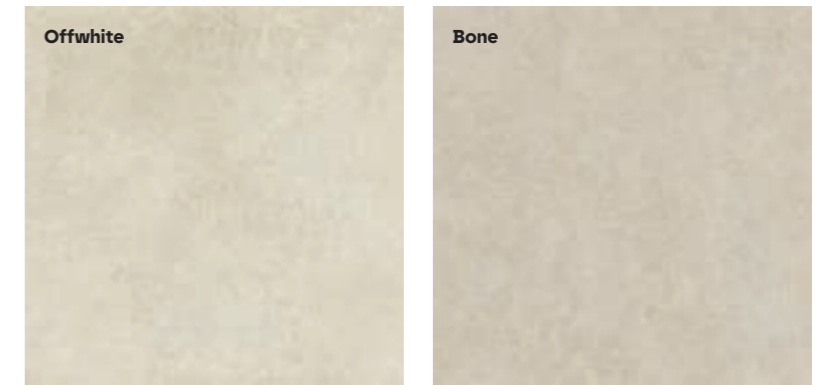
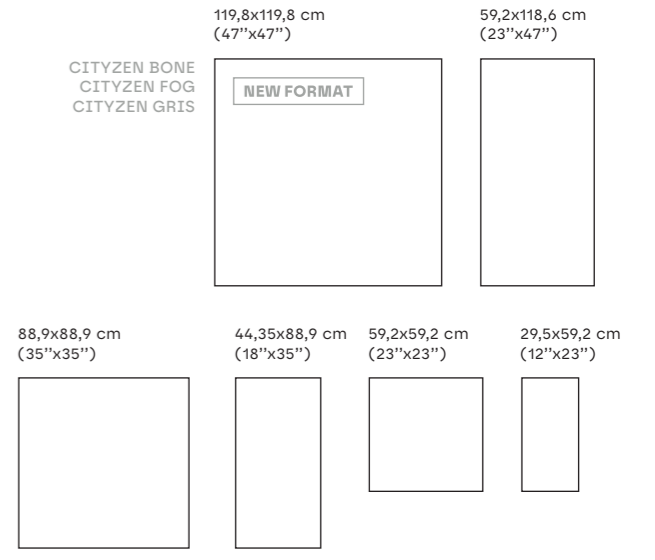



CONCRETE

190

revigres

CITYZEN BONE

LISBOA RACKET CENTER — ALVALADE, PORTUGAL
LISBON RACKET CENTER — ALVALADE, PORTUGAL



CONCRETE

191

revigres

CITYZEN BONE

CITYZEN _ CITYZEN ANTISLIP



CITYZEN OFFWHITE

312B2114U1	29,5x59,2x0,85 cm	MATT RECT	P87
312B1314U1	59,2x59,2x0,85 cm	MATT RECT	P87
312D1314U1	59,2x59,2x0,85 cm	ANTISLIP RECT	P87
312BH814U1	44,35x88,9x1,05 cm	MATT RECT	P91
312BK714U1	88,9x88,9x1,05 cm	MATT RECT	P101
312BD314U1	59,2x118,6x0,98 cm	MATT RECT	P101

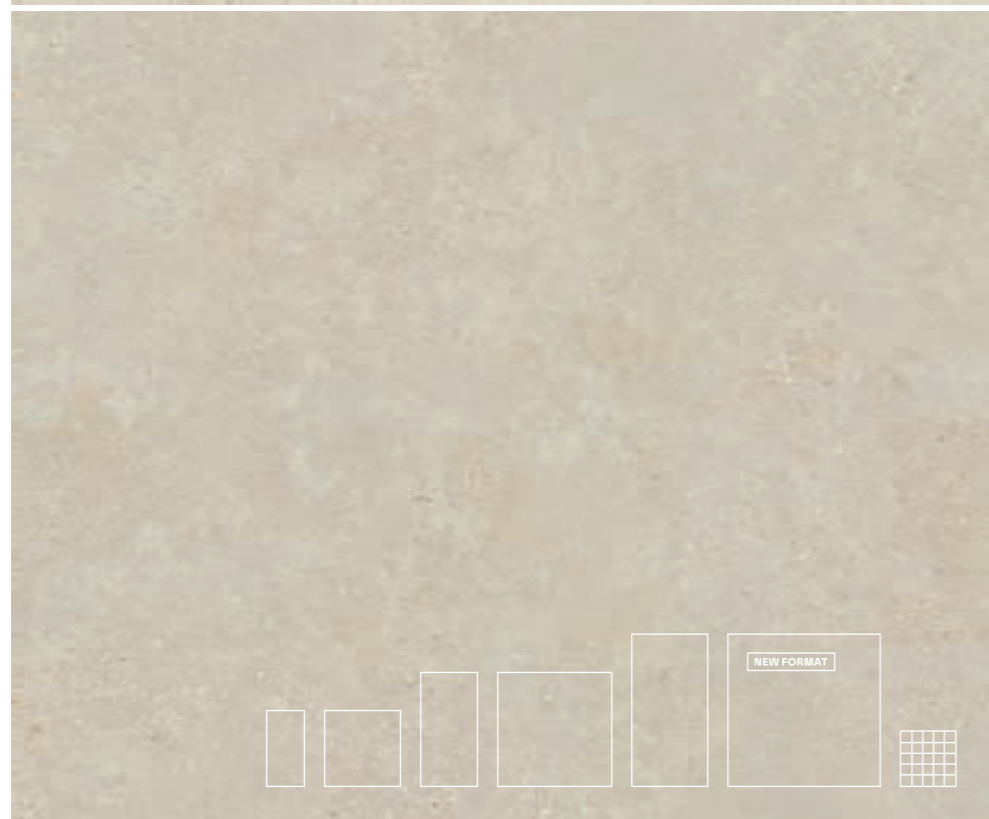

CITYZEN BONE

312B2116U1	29,5x59,2x0,85 cm	MATT RECT	P87
312B1316U1	59,2x59,2x0,85 cm	MATT RECT	P87
312D1316U1	59,2x59,2x0,85 cm	ANTISLIP RECT	P87
312BH816U1	44,35x88,9x1,05 cm	MATT RECT	P91
312BK716U1	88,9x88,9x1,05 cm	MATT RECT	P101
312BD316U1	59,2x118,6x0,98 cm	MATT RECT	P101
NEW 302BX316U1	119,8x119,8x0,90 cm	MATT RECT	P120
NEW 302DX316U1	119,8x119,8x0,90 cm	ANTISLIP RECT	P120

CITYZEN _ CITYZEN ANTISLIP

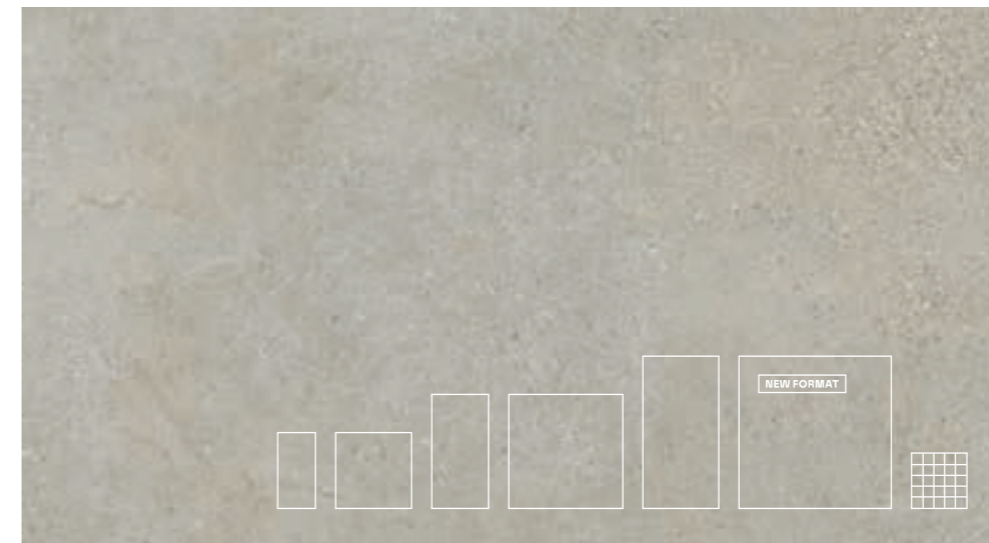

CITYZEN FOG

312B2115U1	29,5x59,2x0,85 cm	MATT RECT	P87
312B1315U1	59,2x59,2x0,85 cm	MATT RECT	P87
312D1315U1	59,2x59,2x0,85 cm	ANTISLIP RECT	P87
312BH815U1	44,35x88,9x1,05 cm	MATT RECT	P91
312BK715U1	88,9x88,9x1,05 cm	MATT RECT	P101
312BD315U1	59,2x118,6x0,98 cm	MATT RECT	P101
NEW 302BX315U1	119,8x119,8x0,90 cm	MATT RECT	P120
NEW 302DX315U1	119,8x119,8x0,90 cm	ANTISLIP RECT	P120



CITYZEN GRIS

312B2118U1	29,5x59,2x0,85 cm	MATT RECT	P87
312B1318U1	59,2x59,2x0,85 cm	MATT RECT	P87
312D1318U1	59,2x59,2x0,85 cm	ANTISLIP RECT	P87
312BH818U1	44,35x88,9x1,05 cm	MATT RECT	P91
312BK718U1	88,9x88,9x1,05 cm	MATT RECT	P101
312BD318U1	59,2x118,6x0,98 cm	MATT RECT	P101
NEW 302BX318U1	119,8x119,8x0,90 cm	MATT RECT	P120
NEW 302DX318U1	119,8x119,8x0,90 cm	ANTISLIP RECT	P120



CITYZEN CARBON

312B2117U1	29,5x59,2x0,85 cm	MATT RECT	P87
312B1317U1	59,2x59,2x0,85 cm	MATT RECT	P87
312D1317U1	59,2x59,2x0,85 cm	ANTISLIP RECT	P87
312BH817U1	44,35x88,9x1,05 cm	MATT RECT	P91
312BK717U1	88,9x88,9x1,05 cm	MATT RECT	P101
312BD317U1	59,2x118,6x0,98 cm	MATT RECT	P101

CONCRETE

CONCRETE



STRATUS 36 (a)(f)

29,5x29,5x0,85 cm MATT RECT **P19 /peça_pieza**
[1m² = 11 peças_piezas]



Produtos que integram alguns materiais reciclados.
Products that incorporate some recycled materials.
Produits intégrant quelques matériaux recyclés.
Productos que incorporan algunos materiales reciclados.

Antislip: Produtos que minimizam o risco de deslizamento.
Antislip: Products that minimize the risk of slipping.
Antislip: Produits qui réduisent le risque de glissement.
Antislip: Productos que minimizan el riesgo de deslizamiento.

Para o assentamento de peças de grande formato, sugerimos a utilização de niveladores para ajudar a posicionar e nivelar peças.
When laying large format tiles, use levelling spacers to ensure proper installing and levelling of tiles.
Pour la pose de pièces de grand format, nous suggérons l'utilisation de croisillons autonivelants pour aider à positionner et à niveler les pièces.
Para la colocación de piezas de gran tamaño, sugerimos utilizar niveladores para ayudar a colocar y nivelar piezas.



29,5x59,2 · 44,35x88,9 · 88,9x88,9 · 59,2x118,6 cm	MATT RECT	V2	5	class 2	A	R10	36+	≥0,42	U4P3E3C2
59,2x59,2 cm	MATT RECT	V2	5	class 2	A	R10	36+	≥0,42	U4P4E3C2
59,2x59,2 cm	ANTISLIP RECT	V2	5	class 3	B	R11	36+	≥0,42	-
119,8x119,8 cm	MATT RECT	V2	4	class 2	A	R10	36+	≥0,42	-
119,8x119,8 cm	ANTISLIP RECT	V2	4	class 3	B	R11	36+	≥0,42	-

CITYZEN _ CITYZEN ANTISLIP



CONCRETE

CITYZEN _ CITYZEN ANTISLIP

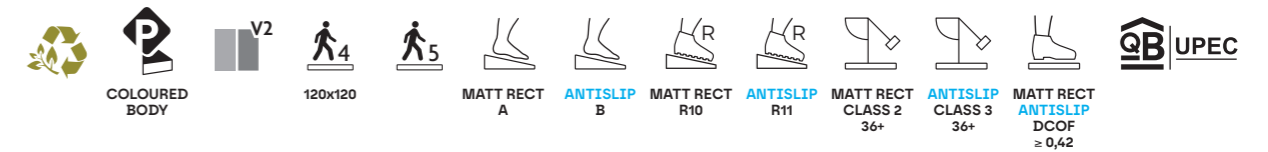

PEÇAS · PIECES		CAIXA · BOX			EUROPALETE · EUROPALLET			
	±	PZ	M ²	KG	CX	M ²	KG	
29,5x59,2 cm	MATT RECT	8,5 ±5%	8	1.40	28.8	32	44.80	943
59,2x59,2 cm	MATT RECT · ANTISLIP	8,5 ±5%	4	1.40	28.7	36	50.40	1053
59,2x118,6 cm	MATT RECT	9,8 ±5%	2	1.40	33.0	30	42.00	1011
44,35x88,9 cm	MATT RECT	10,5 ±5mm	4	1.58	39.0	27	42.66	1074
88,9x88,9 cm	MATT RECT	10,5 ±5mm	2	1.58	39.0	24	37.92	991
119,8x119,8 cm	MATT RECT · ANTISLIP	9,0 ±5%	1	1.44	28.1	32	46.08	959.2

PEÇA · PIECE		PEÇA · PIECE		PEÇA · PIECE		PEÇA · PIECE		PEÇA · PIECE	
DG	MATT RECT ANTISLIP RECT	RB	MATT RECT ANTISLIP RECT	DG CF	MATT RECT ANTISLIP RECT	DG CF SS	MATT RECT ANTISLIP RECT	DG CF CANTO	MATT RECT ANTISLIP RECT
29,5x59,2 cm	P18	9,5x29,5 cm	P08	29,5x59,2 cm	P157	29,5x59,2 cm	P157	29,5x59,2 cm	P207
59,2x59,2 cm	P36	8x44,35 cm	P16						
44,35x88,9 cm	P96	8x59,2 cm	P12						
29,5x118,6 cm	P96	8x88,9 cm	P28						
59,2x118,6 cm	P167	8x118,6 cm	P28						

DG CF Canto: Disponível em canto esquerdo e direito.
 DG CF Canto: Available in left and right corner.
 DG CF Canto: Disponible en angle gauche et droit.
 DG CF Canto: Canto izquierdo y derecho disponibles.

LINEA 2	LINEA 4	LINEA 8
29,5x59,2	29,5x59,2	29,5x59,2

Pág. 44

DG CF / DG CF Canto/DG CF SS: Peças produzidas sob encomenda. Altura do focinho: entre 3 cm e 10 cm. Indicar a altura pretendida no ato da encomenda.
 DG CF / DG CF Canto/DG CF SS: Pieces produced on order. Trim height: 3 to 10 cm. Specify desired height when placing a order.
 DG CF / DG CF Canto/DG CF SS: Pièces produites sur commande. Hauteur du nez de marche : entre 3 cm et 10 cm. Préciser la hauteur souhaitée lors de la commande.
 DG CF / DG CF Canto/DG CF SS: Piezas producidas por encargo. Altura del ángulo: entre 3 y 10 cm. Indicar la altura deseada al realizar el pedido.



DG CF / CF CANTO CITYZEN GRIS

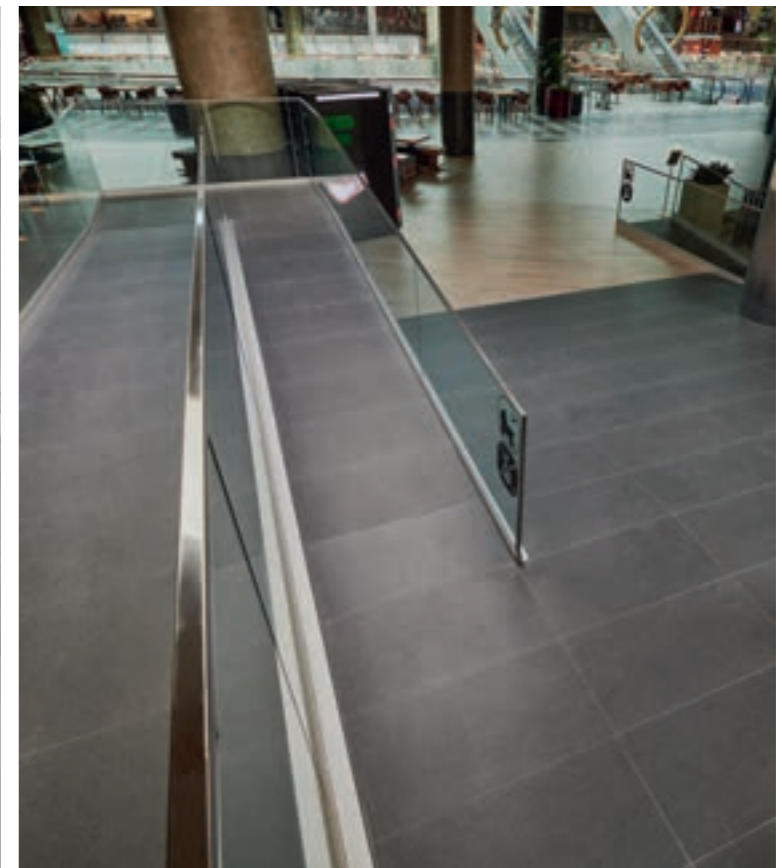

CITYZEN CARBON
 CENTRO COMERCIAL NORTE SHOPPING — PORTO, PORTUGAL
 NORTE SHOPPING CENTER — PORTO, PORTUGAL

CONCRETE



CONCRETE

ELEMENTS

4 cores
colours
couleurs
colores

4 formatos
formats
formats
formatos

2 acabamentos
finishes
finitions
acabados



A nobreza das matérias primas consolidada em espaços urbanos e minimalistas.

The nobility of the raw materials consolidated in urban and minimalist spaces.

La noblesse des matières premières consolidée dans des espaces urbains et minimalistes.

La nobleza de las materias primas consolidada en espacios urbanos y minimalistas.

88,9x88,9 cm
(35"x35")

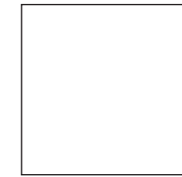

59,2x59,2 cm
(23"x23")



29,5x88,9 cm
(12"x35")



29,5x59,2 cm
(12"x23")



(a) Elements · Elements MixPeak



SOFT · ANTISLIP RECT

RECT

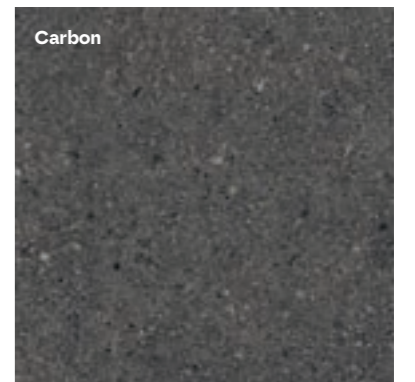
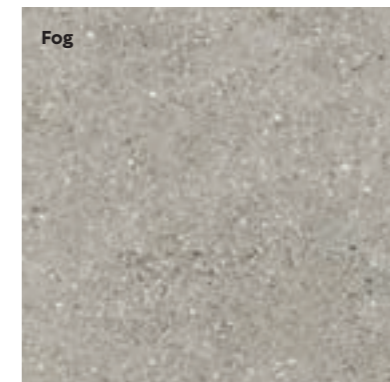

ELEMENTS _ ELEMENTS ANTISLIP



ELEMENTS MIST

3126131U21	59,2x59,2x0,85 cm	SOFT	P96
3121131U21	59,2x59,2x0,85 cm	ANTISLIP RECT	P96
3126K71U21	88,9x88,9x1,05 cm	SOFT	P109
3121K71U21	88,9x88,9x1,05 cm	ANTISLIP RECT	P109

ELEMENTS SMOKE

3126131U31	59,2x59,2x0,85 cm	SOFT	P87
3121131U31	59,2x59,2x0,85 cm	ANTISLIP RECT	P87
3126K71U31	88,9x88,9x1,05 cm	SOFT	P101
3121K71U31	88,9x88,9x1,05 cm	ANTISLIP RECT	P101



ELEMENTS _ ELEMENTS ANTISLIP

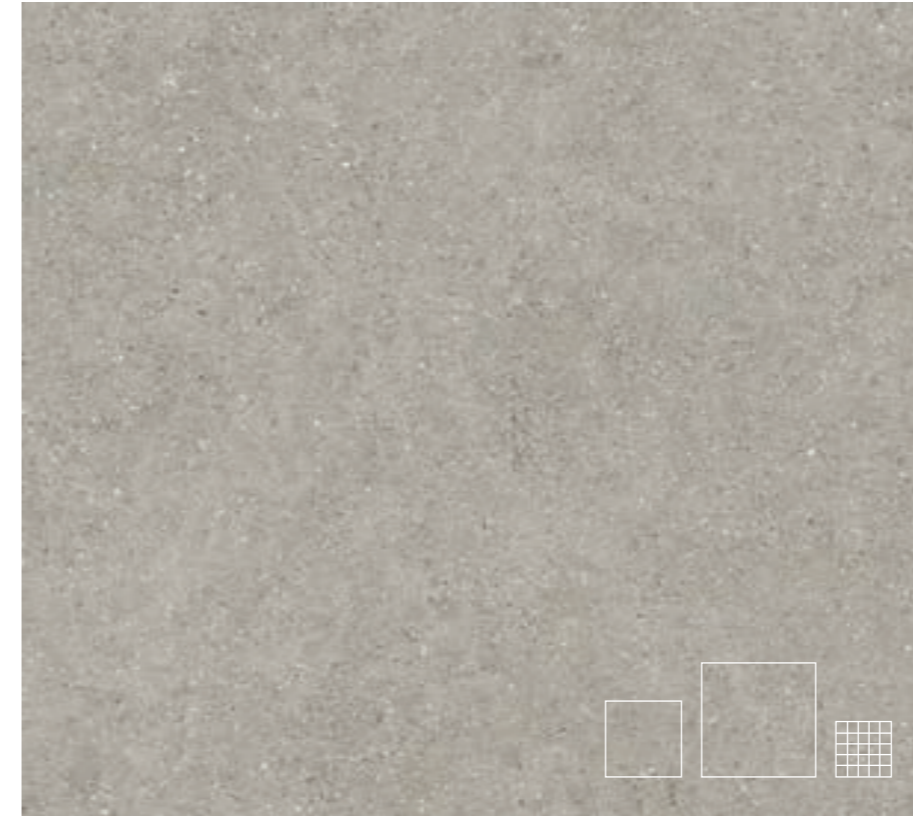

ELEMENTS FOG

3126131U41	59,2x59,2x0,85 cm	SOFT	P87
3121131U41	59,2x59,2x0,85 cm	ANTISLIP RECT	P87
3126K71U41	88,9x88,9x1,05 cm	SOFT	P101
3121K71U41	88,9x88,9x1,05 cm	ANTISLIP RECT	P101

ELEMENTS CARBON

3126131U51	59,2x59,2x0,85 cm	SOFT	P87
3121131U51	59,2x59,2x0,85 cm	ANTISLIP RECT	P87
3126K71U51	88,9x88,9x1,05 cm	SOFT	P101
3121K71U51	88,9x88,9x1,05 cm	ANTISLIP RECT	P101

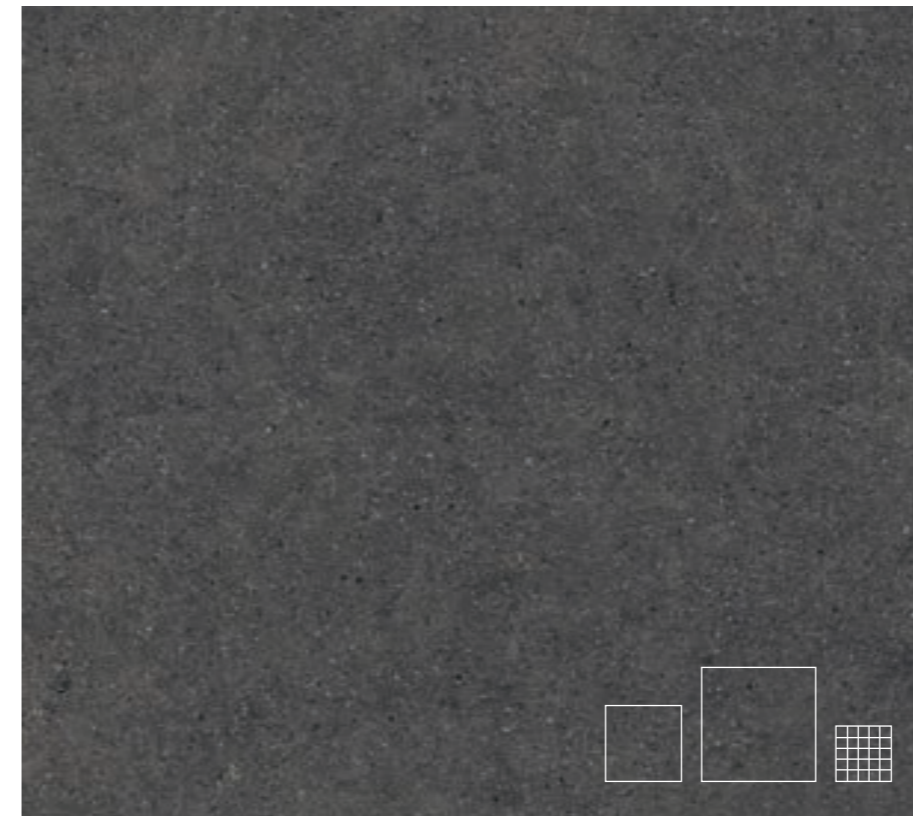

CONCRETE

CONCRETE



STRATUS 36 (a)(f)

29,5x29,5x0,85 cm	SOFT	P19 /peça_piece
[1m² = 11 peças_pieces]		

Antislip: Produtos que minimizam o risco de deslizamento.
Antislip: Products that minimize the risk of slipping.
Antislip: Produits qui réduisent le risque de glissement.
Antislip: Productos que minimizan el riesgo de deslizamiento.



59,2x59,2 cm	SOFT	V2	5	-	-	-	-	-	U4P4E3C2
59,2x59,2 cm	ANTISLIP RECT	V2	5	class 3	B	R11	36+	≥0,42	U4P4E3C2
88,9x88,9 cm	SOFT	V2	5	-	-	-	-	-	U4P3E3C2
88,9x88,9 cm	ANTISLIP RECT	V2	5	class 3	B	R11	36+	≥0,42	U4P3E3C2

ELEMENTS



ELEMENTS MIST

310121G841	29,5x59,2x0,90 cm	RECT	P75
3101G8G841	29,5x88,9x1,23 cm	RECT	P92

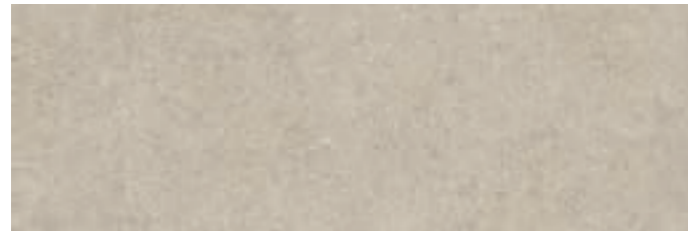

ELEMENTS SMOKE

310121G851	29,5x59,2x0,90 cm	RECT	P75
3101G8G851	29,5x88,9x1,23 cm	RECT	P92

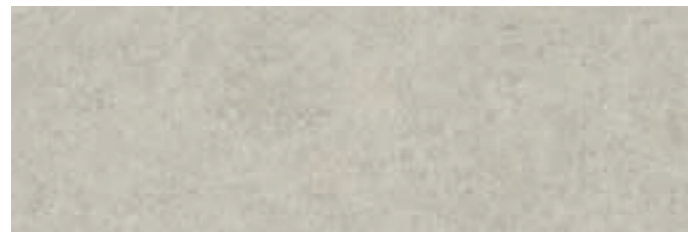

ELEMENTS FOG

310121G861	29,5x59,2x0,90 cm	RECT	P75
3101G8G861	29,5x88,9x1,23 cm	RECT	P92

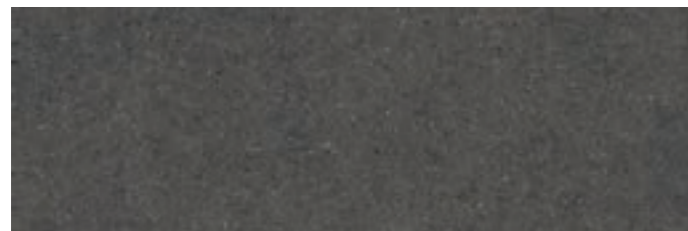

ELEMENTS CARBON

310121G871	29,5x59,2x0,90 cm	RECT	P75
3101G8G871	29,5x88,9x1,23 cm	RECT	P92



MULTIFORM ELEMENTS MIST (a)

330112F471	29,5x29,5x0,90 cm	P20 /peça_pieza
[1m ² = 11 peças_pieces]		



MULTIFORM ELEMENTS FOG (a)

330112F481	29,5x29,5x0,90 cm	P20 /peça_pieza
[1m ² = 11 peças_pieces]		



MULTIFORM ELEMENTS SMOKE (a)

330112F501	29,5x29,5x0,90 cm	P20 /peça_pieza
[1m ² = 11 peças_pieces]		



MULTIFORM ELEMENTS CARBON (a)

330112F491	29,5x29,5x0,90 cm	P20 /peça_pieza
[1m ² = 11 peças_pieces]		

ELEMENTS



ELEMENTS MIXPEAK MIST (*)

310121G921	29,5x59,2x0,90 cm	RECT	P80
3101G8G921	29,5x88,9x1,23 cm	RECT	P94



ELEMENTS MIXPEAK SMOKE (*)

310121G931	29,5x59,2x0,90 cm	RECT	P80
3101G8G931	29,5x88,9x1,23 cm	RECT	P94



ELEMENTS MIXPEAK FOG (*)

310121G941	29,5x59,2x0,90 cm	RECT	P80
3101G8G941	29,5x88,9x1,23 cm	RECT	P94



ELEMENTS MIXPEAK CARBON (*)

310121G951	29,5x59,2x0,90 cm	RECT	P80
3101G8G951	29,5x88,9x1,23 cm	RECT	P94

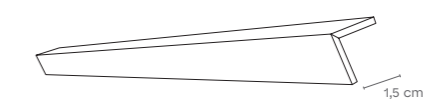
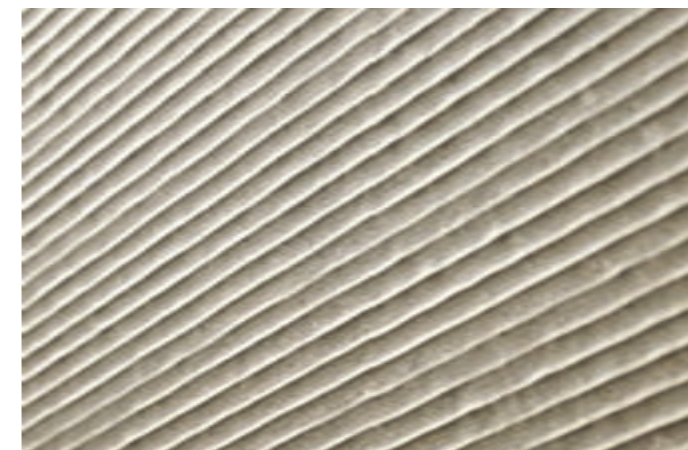

PERFIL			
1,5x29,5x0,90 cm	RECT	P20 /peça_pieza	
1,5x59,2x0,90 cm	RECT	P32 /peça_pieza	

PERFIL: produzido de acordo com quantidades mínimas de 10 peças.
 PERFIL: produced in minimum quantities of 10 pieces.
 PERFIL: produites selon des quantités minimales de 10 pièces.
 PERFIL: producidas en cantidades mínimas de 10 piezas.

(*) Dado o efeito deste produto, as peças devem ser aplicadas sempre no mesmo sentido, seguindo a orientação do dorso.
 (*) Given the effect of the product, tiles must always be laid out facing same direction, following the orientation of the back.
 (*) En raison de l'effet de ce produit, les carreaux doivent toujours être posés dans le même sens, en suivant l'orientation de sa face interne.
 (*) Dado el efecto de este producto, las piezas deben aplicarse siempre en el mismo sentido, siguiendo la orientación del dorso.

ELEMENTS



CONCRETE

ELEMENTS _ ELEMENTS ANTISLIP



PEÇAS · PIECES			CAIXA · BOX			EUROPALETE · EUROPALLET		
		±	PZ	M²	KG	CX	M²	KG
29,5x59,2 cm	RECT	9,0 ±5%	8	1.40	23.20	32	44.80	763
29,5x88,9 cm	RECT	12,3 ±5mm	4	1.05	22.00	40	42.00	901



PEÇAS · PIECES			CAIXA · BOX			EUROPALETE · EUROPALLET		
		±	PZ	M²	KG	CX	M²	KG
59,2x59,2 cm	SOFT · ANTISLIP RECT	8,5 ±5%	4	1.40	28.7	36	50.40	1 053
59,2x118,6 cm	SOFT · ANTISLIP RECT	9,8 ±5%	2	1.40	33.0	30	42.00	1 011
44,35x88,9 cm	SOFT · ANTISLIP RECT	10,5 ±5mm	4	1.58	39.0	27	42.66	1 074
88,9x88,9 cm	SOFT · ANTISLIP RECT	10,5 ±5mm	2	1.58	39.0	24	37.92	991

PEÇA · PIECE		PEÇA · PIECE		PEÇA · PIECE		PEÇA · PIECE		PEÇA · PIECE	
DG	SOFT ANTISLIP RECT	RB	SOFT ANTISLIP RECT	DG CF	SOFT ANTISLIP RECT	DG CF SS	SOFT ANTISLIP RECT	DG CF CANTO	SOFT ANTISLIP RECT
29,5x59,2 cm	P18	8x44,35 cm	P16	29,5x59,2 cm	P157	29,5x59,2 cm	P157	29,5x59,2 cm	P207
59,2x59,2 cm	P36	8x59,2 cm	P12						
44,35x88,9 cm	P96	8x88,9 cm	P28						
29,5x118,6 cm	P96	8x118,6 cm	P28						
59,2x118,6 cm	P167								

DG CF / DG CF Canto/DG CF SS: Peças produzidas sob encomenda. Altura do focinho: entre 3 cm e 10 cm. Indicar a altura pretendida no ato da encomenda.
 DG CF / DG CF Canto/DG CF SS: Pieces produced on order. Trim height: 3 to 10 cm. Specify desired height when placing a order.
 DG CF / DG CF Canto/DG CF SS: Pièces produites sur commande. Hauteur du nez de marche : entre 3 cm et 10 cm. Préciser la hauteur souhaitée lors de la commande.
 DG CF / DG CF Canto/DG CF SS: Piezas producidas por encargo. Altura del ángulo: entre 3 y 10 cm. Indicar la altura deseada al realizar el pedido.

DG CF Canto: Disponível em canto esquerdo e direito.
 DG CF Canto: Available in left and right corner.
 DG CF Canto: Disponible en angle gauche et droit.
 DG CF Canto: Canto izquierdo y derecho disponibles.

CONCRETE

São admissíveis ligeiras diferenças de tonalidade na mesma cor entre os diferentes formatos e tipologias de produto (revestimento cerâmico e grés porcelânico).
 Small differences in shades of the same colour are admissible between different product types (ceramic wall tiles and full body porcelain) and formats.
 De légères différences de tonalité d'une même couleur entre les différents formats et typologies de produits sont admissibles (faïence pâte blanche et grès cérame).
 Se admiten ligeras diferencias de tonalidad en el mismo color entre los diferentes formatos y tipos de producto (revestimiento cerámico y g 188_ res porcelánico).



CONCRETE

204

revigres

URBAN FOG

CONCRETE

URBAN

6 cores / colours / couleurs / colores | 7 formatos / formats / formats / formatos | 2 acabamentos / finishes / finitions / acabados



Inspirada na paisagem de betão das grandes metrópoles.

Inspired by the concrete landscape of large cities.

Inspiré par le paysage de béton des grandes métropoles.

Inspirada en el paisaje de hormigón de las grandes metrópolis.

59,2x118,6 cm (23"x47")



88,9x88,9 cm (35"x35")

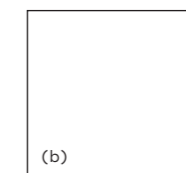

44,35x88,9 cm (18"x35")

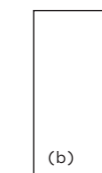

59,2x59,2 cm (23"x23")

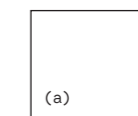

30x60 cm (12"x23")



45x45 cm (18"x18")

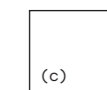

30x30 cm (12"x12")



29,5x59,2 cm (12"x23")

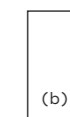

44,35x44,35 cm (18"x18")

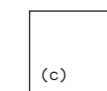

29,5x29,5 cm (12"x12")



(a) Urban · Antislip Urban · TECH20mm
(b) Urban
(c) Urban · Hydraulik



NAT · RECT · ANTISLIP RECT

12
Até 12 desenhos
Up to 12 designs
Jusqu'à 12 dessins
Hasta 12 diseños

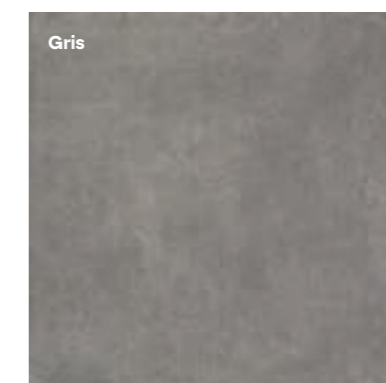
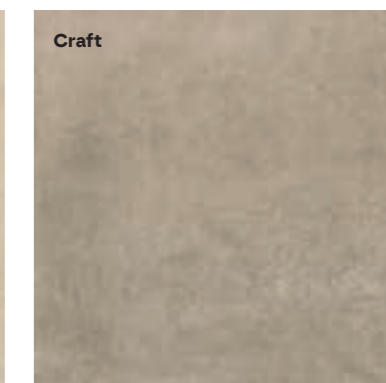
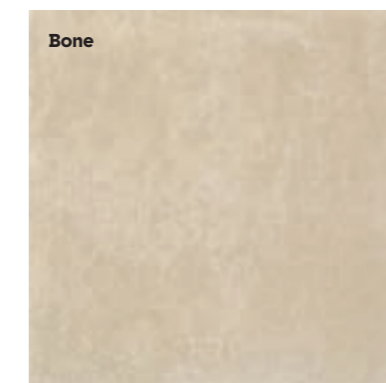

CONCRETE

205

revigres

URBAN _ ANTISLIP URBAN



URBAN OFFWHITE

31201223T1	30x30x0,77 cm	NAT	P66
31211223T1	29,5x29,5x0,77 cm	RECT	P76
31202123T1	30x60x0,85 cm	NAT	P69
31212123T1	29,5x59,2x0,85 cm	RECT	P79
31211323T1	59,2x59,2x0,85 cm	RECT	P87
31200723T1	45x45x0,85 cm	NAT	P69
31210723T1	44,35x44,35x0,85 cm	RECT	P79
3121H823T1	44,35x88,9x1,05 cm	RECT	P91
3121K723T1	88,9x88,9x1,05 cm	RECT	P101
3121D323T1	59,2x118,6x0,98 cm	RECT	P101

ANTISLIP URBAN OFFWHITE

31211334T1	59,2x59,2x0,85 cm	RECT	P87
------------	-------------------	------	-----

URBAN BONE

31201220T1	30x30x0,77 cm	NAT	P66
312112671	29,5x29,5x0,77 cm	RECT	P76
31202120T1	30x60x0,85 cm	NAT	P69
31212120T1	29,5x59,2x0,85 cm	RECT	P79
31211320T1	59,2x59,2x0,85 cm	RECT	P87
31200720T1	45x45x0,85 cm	NAT	P69
31210720T1	44,35x44,35x0,85 cm	RECT	P79
3121H820T1	44,35x88,9x1,05 cm	RECT	P91
3121K720T1	88,9x88,9x1,05 cm	RECT	P101
3121D320T1	59,2x118,6x0,98 cm	RECT	P101

ANTISLIP URBAN BONE

31211331T1	59,2x59,2x0,85 cm	RECT	P87
------------	-------------------	------	-----

ANTISLIP URBAN BONE **TECH²⁰mm**

NEW 302D1348V1	59,8x59,8x2,00 cm	RECT	P103
-----------------------	-------------------	------	------



URBAN _ ANTISLIP URBAN



URBAN CRAFT

31201224T1	30x30x0,77 cm	NAT	P66
31211224T1	29,5x29,5x0,77 cm	RECT	P76
31202124T1	30x60x0,85 cm	NAT	P69
31212124T1	29,5x59,2x0,85 cm	RECT	P79
31211324T1	59,2x59,2x0,85 cm	RECT	P87
31200724T1	45x45x0,85 cm	NAT	P69
31210724T1	44,35x44,35x0,85 cm	RECT	P79
3121H824T1	44,35x88,9x1,05 cm	RECT	P91
3121K724T1	88,9x88,9x1,05 cm	RECT	P101
3121D324T1	59,2x118,6x0,98 cm	RECT	P101

ANTISLIP URBAN CRAFT

31211335T1	59,2x59,2x0,85 cm	RECT	P87
------------	-------------------	------	-----

URBAN FOG

31201221T1	30x30x0,77 cm	NAT	P66
31211221T1	29,5x29,5x0,77 cm	RECT	P76
31202121T1	30x60x0,85 cm	NAT	P69
31212121T1	29,5x59,2x0,85 cm	RECT	P79
31211321T1	59,2x59,2x0,85 cm	RECT	P87
31200721T1	45x45x0,85 cm	NAT	P69
31210721T1	44,35x44,35x0,85 cm	RECT	P79
3121H821T1	44,35x88,9x1,05 cm	RECT	P91
3121K721T1	88,9x88,9x1,05 cm	RECT	P101
3121D321T1	59,2x118,6x0,98 cm	RECT	P101

ANTISLIP URBAN FOG

31211332T1	59,2x59,2x0,85 cm	RECT	P87
------------	-------------------	------	-----

ANTISLIP URBAN FOG **TECH²⁰mm**

NEW 302D1349V1	59,8x59,8x2,00 cm	RECT	P103
-----------------------	-------------------	------	------



STRATUS 36 (a)(f)

29,5x29,5x0,85 cm	RECT	P19 /peça_piece
[1m ² = 11 peças_pieces]		



Produtos que integram alguns materiais reciclados.
Products that incorporate some recycled materials.
Produits intégrant quelques matériaux recyclés.
Productos que incorporan algunos materiales reciclados.

Antislip: Produtos que minimizam o risco de deslizamento.
Antislip: Products that minimize the risk of slipping.
Antislip: Produits qui réduisent le risque de glissement.
Antislip: Productos que minimizan el riesgo de deslizamiento.



30x60 cm	NAT	V2	5	class 1	A	R9	-	≥0,42	U4P3E3C2
29,5x59,2 · 44,35x88,9 · 88,9x88,9 · 59,2x118,6 cm	RECT	V2	5	class 1	A	R9	-	≥0,42	U4P3E3C2
30x30 · 45x45 cm	NAT	V2	5	class 1	A	R9	-	≥0,42	U4P4E3C2
29,5x29,5 · 44,35x44,35 · 59,2x59,2 cm	RECT	V2	5	class 1	A	R9	-	≥0,42	U4P4E3C2
59,2x59,2 cm	ANTISLIP RECT	V2	5	class 3	B	R11	36+	≥0,42	U4P4E3C2
59,8x59,8 cm 20 mm	ANTISLIP RECT	V2	4	class 3	C	R11	36+	≥0,42	-

URBAN _ ANTISLIP URBAN



URBAN GRIS

31201222T1	30x30x0,77 cm	NAT	P66
31211222T1	29,5x29,5x0,77 cm	RECT	P76
31202122T1	30x60x0,85 cm	NAT	P69
31212122T1	29,5x59,2x0,85 cm	RECT	P79
31211322T1	59,2x59,2x0,85 cm	RECT	P87
31200722T1	45x45x0,85 cm	NAT	P69
31210722T1	44,35x44,35x0,85 cm	RECT	P79
3121H822T1	44,35x88,9x1,05 cm	RECT	P91
3121K722T1	88,9x88,9x1,05 cm	RECT	P101
3121D322T1	59,2x118,6x0,98 cm	RECT	P101

ANTISLIP URBAN GRIS

31211333T1	59,2x59,2x0,85 cm	RECT	P87
------------	-------------------	------	-----

ANTISLIP URBAN GRIS **TECH 20 mm**

NEW 302D1350V1	59,8x59,8x2,00 cm	RECT	P103
-----------------------	-------------------	------	------

URBAN ANTRACITE

31201248U1	30x30x0,77 cm	NAT	P66
31211248U1	29,5x29,5x0,77 cm	RECT	P76
31202148U1	30x60x0,85 cm	NAT	P69
31212148U1	29,5x59,2x0,85 cm	RECT	P79
31211348U1	59,2x59,2x0,85 cm	RECT	P87
31200748U1	45x45x0,85 cm	NAT	P69
31210748U1	44,35x44,35x0,85 cm	RECT	P79
3121H848U1	44,35x88,9x1,05 cm	RECT	P91
3121K748U1	88,9x88,9x1,05 cm	RECT	P101
3121D348U1	59,2x118,6x0,98 cm	RECT	P101

ANTISLIP URBAN ANTRACITE

31211349U1	59,2x59,2x0,85 cm	RECT	P87
------------	-------------------	------	-----



URBAN _ ANTISLIP URBAN



URBAN FOG _ HYDRAULIK FOG



30x60 cm	NAT	V2	5	class 1	A	R9	-	≥0,42	U4P3E3C2
29,5x59,2 · 44,35x88,9 · 88,9x88,9 · 59,2x118,6 cm	RECT	V2	5	class 1	A	R9	-	≥0,42	U4P3E3C2
30x30 · 45x45 cm	NAT	V2	5	class 1	A	R9	-	≥0,42	U4P4E3C2
29,5x29,5 · 44,35x44,35 · 59,2x59,2 cm	RECT	V2	5	class 1	A	R9	-	≥0,42	U4P4E3C2
59,2x59,2 cm	ANTISLIP RECT	V2	5	class 3	B	R11	36+	≥0,42	U4P4E3C2
59,8x59,8 cm 20 mm	ANTISLIP RECT	V2	4	class 3	C	R11	36+	≥0,42	-



STRATUS 36 (a)(f)

29,5x29,5x0,85 cm	RECT	P19 /peça_pieza
-------------------	------	-----------------

[1m² = 11 peças_pieces]



Produtos que integram alguns materiais reciclados.
Products that incorporate some recycled materials.
Produits intégrant quelques matériaux recyclés.
Productos que incorporan algunos materiales reciclados.

Antislip: Produtos que minimizam o risco de deslizamento.
Antislip: Products that minimize the risk of slipping.
Antislip: Produits qui réduisent le risque de glissement.
Antislip: Productos que minimizan el riesgo de deslizamiento.

URBAN _ ANTISLIP URBAN



ANTISLIP URBAN BONE 20 mm

URBAN _ ANTISLIP URBAN

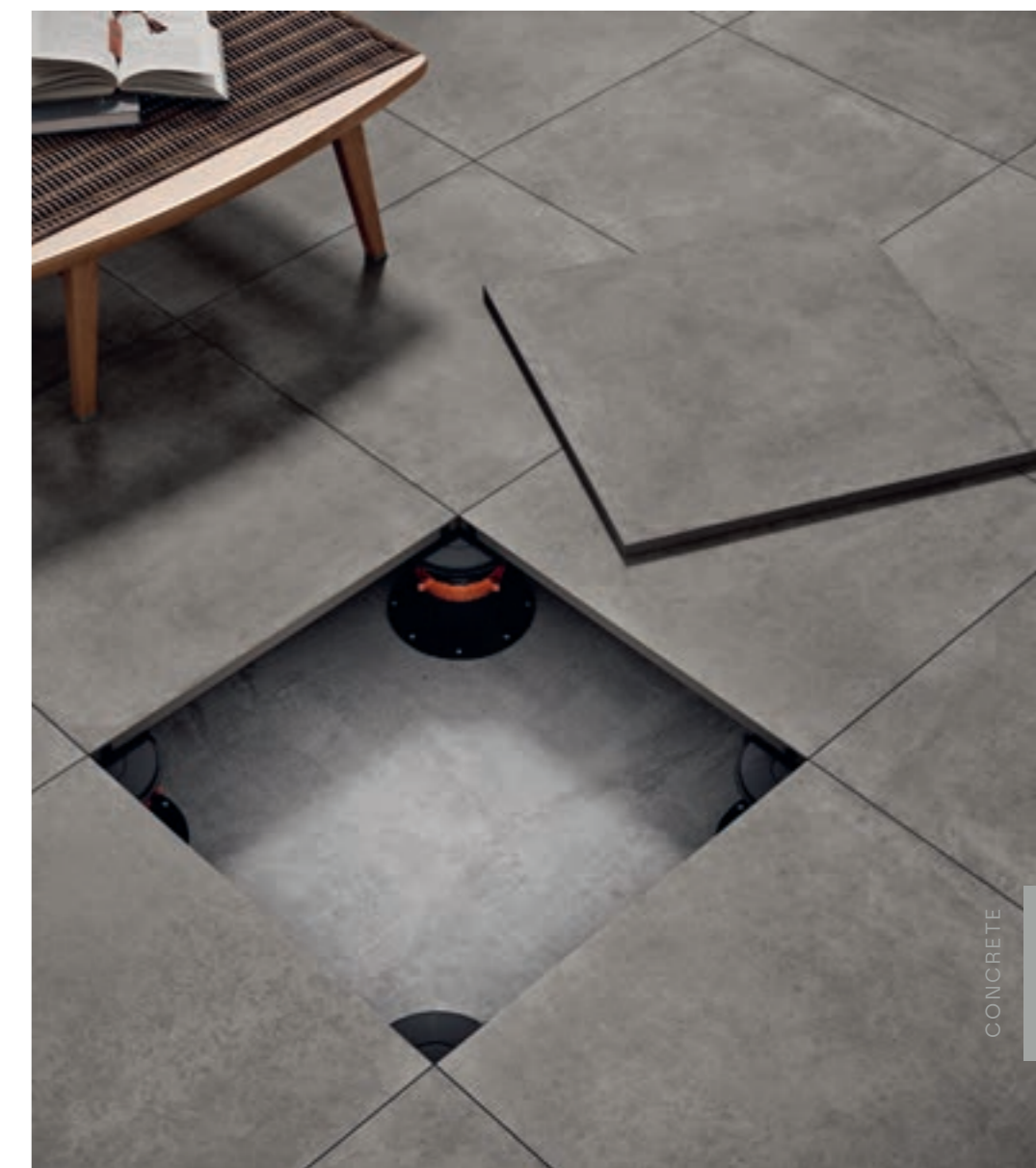

ANTISLIP URBAN GRIS 20 mm

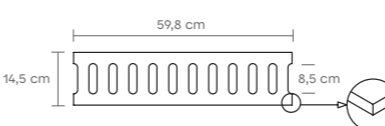

GRELHA DE TRANSBORDAMENTO
14,5x59,8x2 cm P127

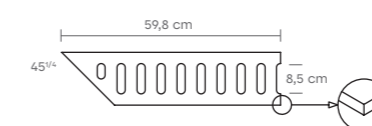

GRELHA DE TRANSBORDAMENTO CANTO
2 PEÇAS _ PIECES
14,5x59,8x2 cm P237

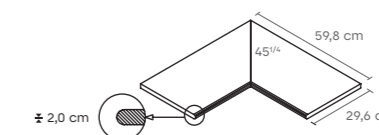

CANTO INTERIOR BOLEADO
2 PEÇAS _ PIECES
29,6x59,8x2 cm P237

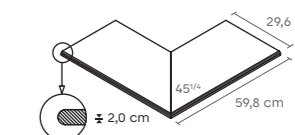

CANTO EXTERIOR BOLEADO
2 PEÇAS _ PIECES
29,6x59,8x2 cm P237

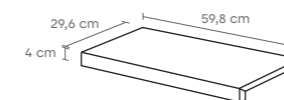

DG CF
29,6x59,8x4 cm P157

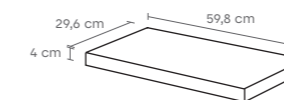

DG CF CANTO
29,6x59,8x4 cm P247

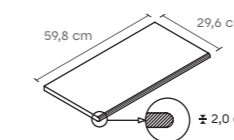

DG BOLEADO
29,6x59,8x2 cm P115

O TECH 20 mm é ideal para jardins, parques, terraços e espaços privados ou públicos de alto tráfego. Através da aplicação a seco, pode ser colocado sobre gravilha, relva, superfícies irregulares e pavimentos técnicos sobreelevados. De fácil e rápida aplicação, é ainda removível.

Com cimento cola, representa um produto de altíssima resistência mecânica, sendo adequado para garagens, espaços comerciais ou industriais. A solução ideal para combinar pavimento interior e exterior.

TECH 20 mm is perfect for gardens, parks, terraces and private or heavy-duty public spaces. Through dry application, it can be laid on gravel, grass, uneven surfaces and raised floor. Easy and quick to install, and easily removable.

Laid with adhesive cement the tiles acquire very high mechanical strength; perfect for garages, commercial or industrial spaces. The ideal solution for combining indoor and outdoor flooring.

TECH 20 mm est idéal pour les jardins, les parcs, les terrasses et les espaces privés ou publics à fort trafic. Grâce à la pose à sec, il peut être posé sur du gravier, du gazon, des surfaces irrégulières et des planchers techniques surélevés. Facile et rapide à poser, il est également amovible.

Avec le ciment-colle, il représente un produit de très haute résistance mécanique, approprié pour les garages, les espaces commerciaux ou industriels. La solution idéale pour combiner les sols intérieurs et extérieurs.

TECH 20 mm es ideal para jardines, parques, terrazas y espacios privados o públicos con mucho tráfico. Si se aplica en seco, se puede colocar sobre gravilla, hierba, superficies irregulares y pavimentos técnicos elevados. Ofrece una aplicación fácil y rápida, además de ser removible.

Si se aplica con cemento cola, es un producto con una altísima resistencia mecánica, lo que lo hace adecuado para garajes, espacios comerciales o industriales. La solución ideal para combinar pavimento interior y exterior.

Disponíveis noutros formatos mediante consulta.
Other sizes available on request.
Disponibles dans d'autres formats sur demande.
Disponible en otros formatos bajo presupuesto.

HYDRAULIK



HYDRAULIK OFFWHITE

31200758T1	45x45x0,85 cm	NAT	P73
31210758T1	44,35x44,35x0,85 cm	RECT	P83



HYDRAULIK FOG

31200756T1	45x45x0,85 cm	NAT	P73
31210756T1	44,35x44,35x0,85 cm	RECT	P83

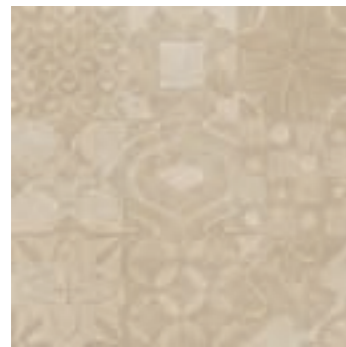

HYDRAULIK BONE

31200754T1	45x45x0,85 cm	NAT	P73
31210754T1	44,35x44,35x0,85 cm	RECT	P83

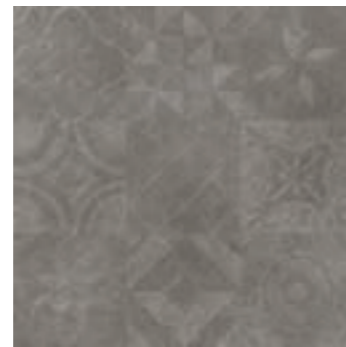

HYDRAULIK GRIS

31200757T1	45x45x0,85 cm	NAT	P73
31210757T1	44,35x44,35x0,85 cm	RECT	P83



HYDRAULIK CRAFT

31200755T1	45x45x0,85 cm	NAT	P73
31210755T1	44,35x44,35x0,85 cm	RECT	P83

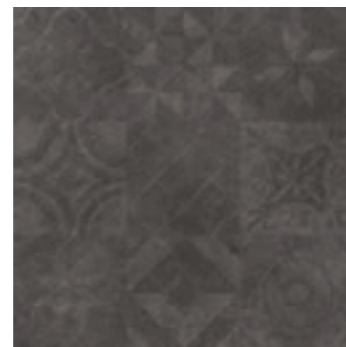

HYDRAULIK ANTRACITE

31200752U1	45x45x0,85 cm	NAT	P73
31210752U1	44,35x44,35x0,85 cm	RECT	P83

Produtos que integram alguns materiais reciclados.
Products that incorporate some recycled materials.
Produits intégrant quelques matériaux recyclés.
Productos que incorporan algunos materiales reciclados.

Existem 4 peças diferentes, de acordo com o desenho do decorado, que devem ser aplicadas alternadamente, de modo a obter-se uma solução mais rica e variada.

There are 4 pieces, matching the design of the decorated tiles, which should be applied alternately in order to obtain a richer and more varied decoration.

4 différentes pièces correspondent au dessin du décor. Il convient de les appliquer de façon alternée pour obtenir une disposition plus riche et plus variée.

Existen 4 piezas diferentes, de acuerdo con el diseño del decorado, que deben aplicarse de forma alterna, con el fin de obtener una solución más rica y variada.



45x45 cm	NAT	V3	4	class 1	A	R9
44,35x44,35 cm	RECT	V3	4	class 1	A	R9

URBAN - ANTISLIP URBAN



PEÇAS · PIECES			CAIXA · BOX			EUROPALETE · EUROPALLET		
		±	PZ	M ²	KG	CX	M ²	KG
30x30 cm	NAT	7,7 ±5%	16	1.44	28.0	40	57.60	1 141
29,5x29,5 cm	RECT	7,7 ±5%	16	1.39	28.0	40	55.60	1 141
45x45 cm	NAT	8,5 ±5%	6	1.22	24.0	34	41.48	837
44,35x44,35 cm	RECT	8,5 ±5%	6	1.18	24.0	34	40.12	837
30x60 cm	NAT	8,5 ±5%	8	1.44	28.8	32	46.08	943
29,5x59,2 cm	RECT	8,5 ±5%	8	1.40	28.8	32	44.80	943
59,2x59,2 cm	RECT · ANTISLIP	8,5 ±5%	4	1.40	28.7	36	50.40	1 053
59,8x59,8 cm	ANTISLIP RECT	20,0 ±5mm	2	0.72	30.96	32	23.04	990.72
44,35x88,9 cm	RECT	10,5 ±5mm	4	1.58	39.0	24	37.92	991
88,9x88,9 cm	RECT	10,5 ±5mm	2	1.58	39.0	24	37.92	991
59,2x118,6 cm	RECT	9,8 ±5%	2	1.40	33.0	30	42.00	1 011

PEÇA · PIECE			PEÇA · PIECE			DG CF		DG CF SS		DG CF CANTO	
DG	NAT	RECT ANTISLIP	RB	NAT	RECT ANTISLIP	DG CF	RECT ANTISLIP	DG CF SS	RECT ANTISLIP	DG CF CANTO	RECT ANTISLIP
29,5x29,5 cm	P08	P10	9,5x29,5 cm	P07	P08	29,5x59,2 cm	P157	29,5x59,2 cm	P157	29,5x59,2 cm	P207
29,5x59,2 cm	P12	P18	8x44,35 cm	P07	P08						
59,2x59,2 cm	-	P36	8x59,2 cm	P10	P12						
44,35x44,35 cm	P12	P18	8x88,9 cm	-	P28						
44,35x88,9 cm	-	P96	8x118,6 cm	-	P28						
29,5x118,6 cm	-	P96									
59,2x118,6 cm	-	P167									

DG CF / DG CF Canto/DG CF SS: Peças produzidas sob encomenda. Altura do flocinho: entre 3 cm e 10 cm. Indicar a altura pretendida no ato da encomenda.
DG CF / DG CF Canto/DG CF SS: Pieces produced on order. Trim height: 3 to 10 cm. Specify desired height when placing a order.
DG CF / DG CF Canto/DG CF SS: Pièces produites sur commande. Hauteur du nez de marche : entre 3 cm et 10 cm. Préciser la hauteur souhaitée lors de la commande.
DG CF / DG CF Canto/DG CF SS: Piezas producidas por encargo. Altura del ángulo: entre 3 y 10 cm. Indicar la altura deseada al realizar el pedido.

DG CF Canto: Disponível em canto esquerdo e direito.
DG CF Canto: Available in left and right corner.
DG CF Canto: Disponible en angle gauche et droit.
DG CF Canto: Canto izquierdo y derecho disponibles.

LINEA 2	LINEA 4	LINEA 8
29,5x29,5 29,5x59,2	29,5x29,5 29,5x59,2	29,5x29,5 29,5x59,2
CROSS 8	CROSS 16	CROSS 32
29,5x29,5	29,5x29,5	29,5x29,5
SQUARE 4	SQUARE 16	SQUARE 64
29,5x29,5	29,5x29,5	29,5x29,5



HYDRAULIK CRAFT



CONCRETE

SILKEN

5 cores
colours
couleurs
colores

1 formato
format
formato

1 acabamento
finish
finition
acabado



Revestimentos contemporâneos com um toque urbano.

Modern wall tiles with an urban touch.

Des revêtements contemporains avec une touche urbaine.

Revestimientos contemporâneos con un toque urbano.

29,5x59,2 cm
(12"x23")



RECT

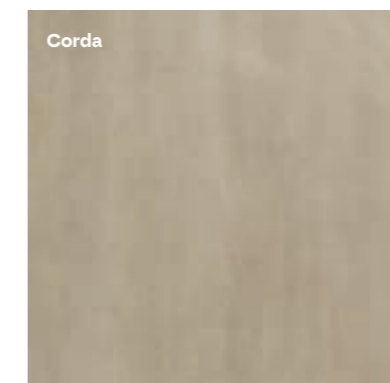
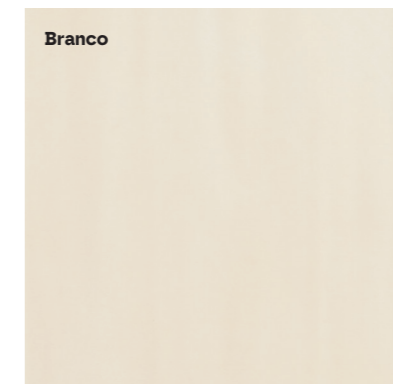

SILKEN



SILKEN BRANCO

31012194C1 29,5x59,2x0,90 cm RECT P75

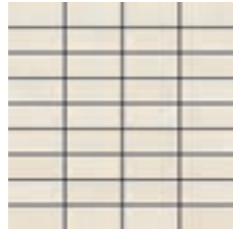

CROSS 36 SILKEN BRANCO (a)

310112F151 29,5x29,5x0,90 cm P17 /peça_piece
[1m² = 11 peças_pieces]



SILKEN FOG

31012196C1 29,5x59,2x0,90 cm RECT P75



CROSS 36 SILKEN FOG (a)

310112F171 29,5x29,5x0,90 cm P17 /peça_piece
[1m² = 11 peças_pieces]



SILKEN CORDA

31012195C1 29,5x59,2x0,90 cm RECT P75



CROSS 36 SILKEN CORDA (a)

310112F161 29,5x29,5x0,90 cm P17 /peça_piece
[1m² = 11 peças_pieces]



SILKEN GRIS

31012197C1 29,5x59,2x0,90 cm RECT P75



CROSS 36 SILKEN GRIS (a)

310112F181 29,5x29,5x0,90 cm P17 /peça_piece
[1m² = 11 peças_pieces]

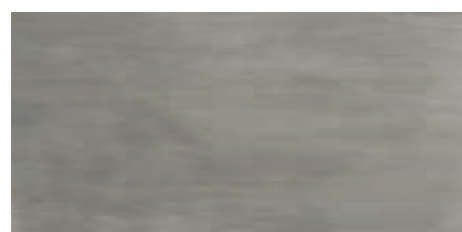

SILKEN ANTRACITE

31012193C1 29,5x59,2x0,90 cm RECT P75



CROSS 36 SILKEN ANTRACITE (a)

310112F141 29,5x29,5x0,90 cm P17 /peça_piece
[1m² = 11 peças_pieces]



SILKEN ANTRACITE _ CROSS 36 SILKEN ANTRACITE

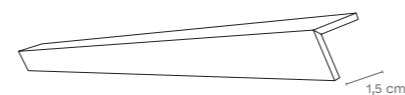

PERFIL		
1,5x29,5x0,90 cm	RECT	P20 /peça_piece
1,5x59,2x0,90 cm	RECT	P32 /peça_piece

PERFIL: produzido de acordo com quantidades mínimas de 10 peças.
PERFIL: produced in minimum quantities of 10 pieces.
PERFIL: produites selon des quantités minimales de 10 pièces.
PERFIL: producidas en cantidades mínimas de 10 piezas.

ATELIER _ MINIMAL



ATELIER OCRE (*)

31012100C1 29,5x59,2x0,90 cm RECT P80



ATELIER OLIVA (**)

310121G011 29,5x59,2x0,90 cm RECT P80



ATELIER TERRACOTTA (**)

310121G021 29,5x59,2x0,90 cm RECT P80



MINIMAL GRIS (**)

31012199C1 29,5x59,2x0,90 cm RECT P80



ATELIER OCRE

PEÇAS · PIECES		CAIXA · BOX			EUROPALETE · EUROPALLET			
≠		PZ	M²	KG	CX	M²	KG	
29,5x59,2 cm	RECT	9,0 ±5%	8	1.40	23.20	32	44.80	763

(*) Existem 2 peças diferentes, de acordo com o desenho do decorado, que devem ser aplicadas alternadamente, de modo a obter-se uma solução mais rica e variada.
(*) There are 2 pieces, matching the design of the decorated tiles, which should be applied alternately in order to obtain a richer and more varied decoration.
(*) 2 pièces correspondent au dessin du décor. Il convient de les appliquer de façon alternée pour obtenir une disposition plus riche et plus variée.
(*) Existen 2 piezas diferentes, de acuerdo con el diseño del decorado, que deben aplicarse de forma alterna, con el fin de obtener una solución más rica y variada.



STONES

NEW FORMAT	LIGHT XL	Limestone	220	
	NEW	Travertino Classic	228	
	NEW	TECH^{20mm}	Lavastone	232
		Di Alba Stone	240	
		French Stone	246	
		Slate	252	
		Xisto	258	
		Arizona	266	
		Edicer Pedralva	270	

STONES

LIMESTONE

2 cores
colours
couleurs
colores

7 formatos
formats
formats
formatos

2 acabamentos
finishes
finitions
acabados



Uma odisseia de minerais e traços delicados intrínsecos à textura natural da pedra calcária criam espaços serenos, no interior e exterior.

An odyssey of minerals and delicate strokes intrinsic to the natural texture of limestone replicates serene spaces, indoor and outdoor.

Une odysée de minéraux et de traits délicats intrinsèques à la texture naturelle de la pierre calcaire, recrée des espaces sereins, à l'intérieur comme à l'extérieur.

Una odisea de minerales y delicados trazos intrínsecos a la textura natural de la piedra caliza crean espacios serenos, tanto en interiores como en exteriores.

119,8x119,8 cm
(47"x47")

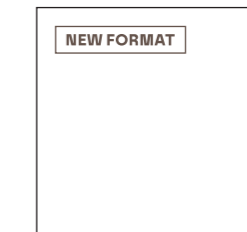

59,2x118,6 cm
(23"x47")

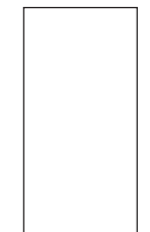

59,2x59,2 cm
(23"x23")



29,5x59,2 cm
(12"x23")



119,8x277,8 cm
(47"x109")



88,9x88,9 cm
(35"x35")

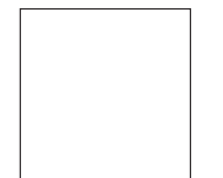

44,35x88,9 cm
(18"x35")



RECT · ANTISLIP RECT



16

Até 16 desenhos
Up to 16 designs
Jusqu'à 16 dessins
Hasta 16 diseños

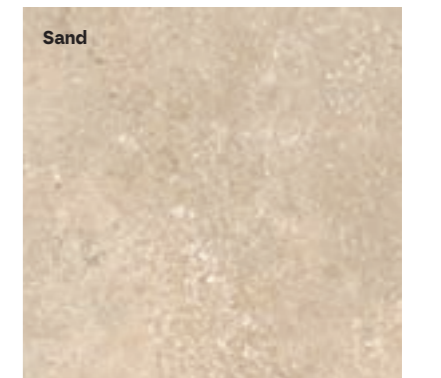
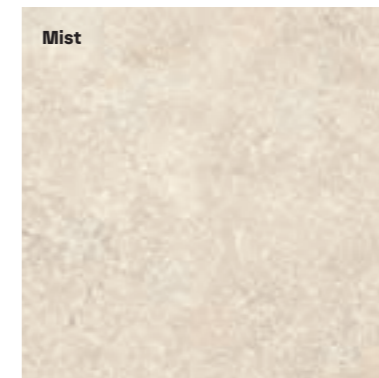

LIMESTONE SAND _ CROMÁTICA LAGOON

L I M E S T O N E

LIGHT XL



L I M E S T O N E M I S T

3021X45V21	119,8x277,8x0,60 cm	RECT	P145
------------	---------------------	------	------

Até 4 desenhos
Up to 4 designs
Jusqu'à 4 dessins
Hasta 4 diseños

GRAPHIC VARIATION



L I M E S T O N E

LIGHT XL

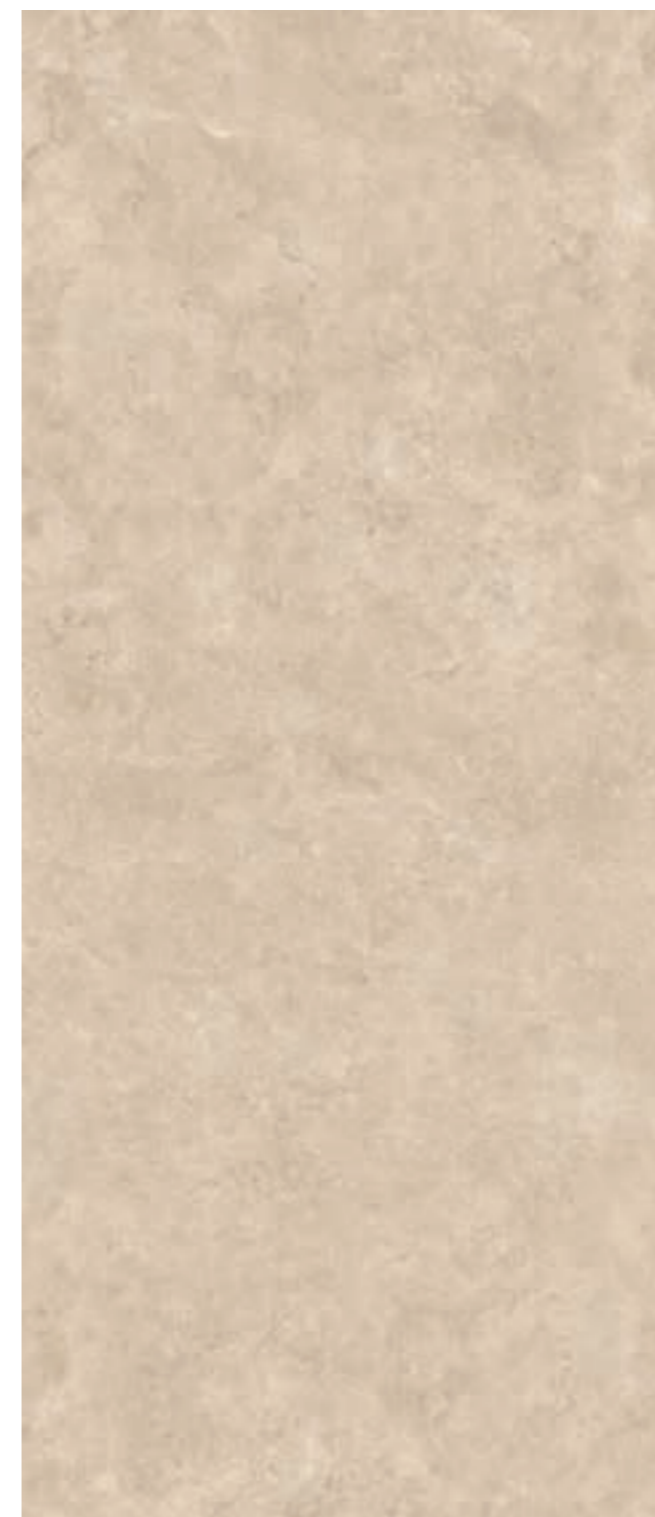

L I M E S T O N E S A N D

3021X45V31	119,8x277,8x0,60 cm	RECT	P145
------------	---------------------	------	------

Até 4 desenhos
Up to 4 designs
Jusqu'à 4 dessins
Hasta 4 diseños

GRAPHIC VARIATION

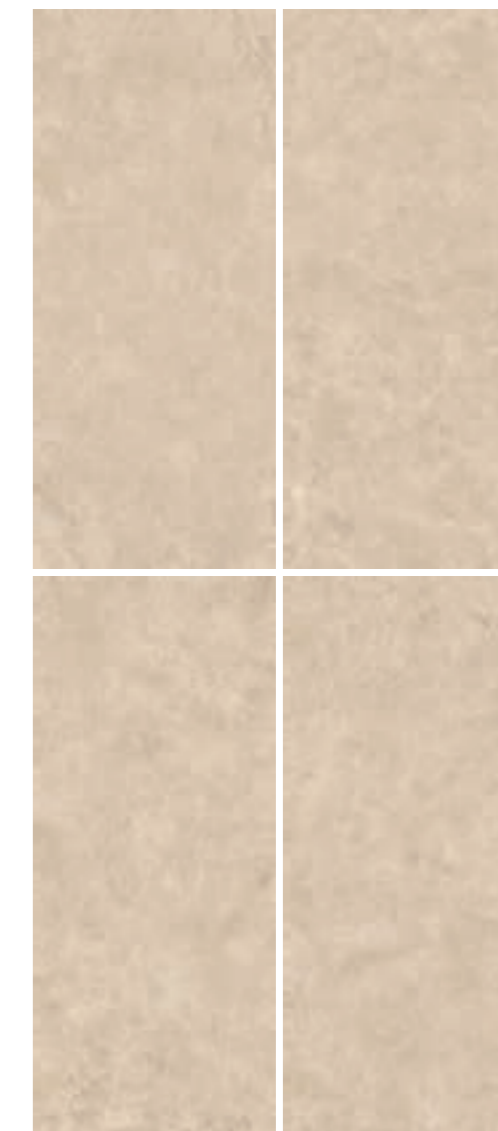

Tendo em vista alcançar um efeito global mais real e harmonioso, são produzidas peças diferentes umas das outras com variações de desenho e/ou cores entre elas.
For a more genuine and harmonious effect overall, different tiles with design and/or colour variations are produced.
Afin d'obtenir un effet global plus réel et harmonieux, nos pièces sont différentes les unes des autres avec des variations de dessin et / ou de nuances entre elles.
Para lograr un efecto global más real y armonioso, se producen piezas diferentes unas de otras con variaciones de diseño y/o color.

Para o assentamento de peças de grande formato, sugerimos a utilização de niveladores para ajudar a posicionar e nivelar peças.
When laying large format tiles, use levelling spacers to ensure proper installing and levelling of tiles.

Pour la pose de pièces de grand format, nous suggérons l'utilisation de croisillons autonivelants pour aider à positionner et à niveler les pièces.
Para la colocación de piezas de gran tamaño, sugerimos utilizar niveladores para ayudar a colocar y nivelar piezas.

LIGHT XL é ideal para renovações, sem demolições. Este grande formato de espessura fina garante a qualidade técnica do grés porcelânico aliada ao efeito estético apresentado.

LIGHT XL is perfect for renovation without demolition. This large, thin format guarantees the technical quality of porcelain tiles combined with the aesthetic effect described above.

LIGHT XL est idéal pour les rénovations, sans démolition. Ce grand format de faible épaisseur garantit la qualité technique du grés cérame combinée à l'effet esthétique présenté.

LIGHT XL es ideal para renovaciones, sin demoliciones. Este gran formato, con espesor fino, garantiza la calidad técnica del gres porcelánico aliado al efecto estético que presenta.

Fornecido em caixa de madeira: preço sob consulta.
Delivered in a wooden box: price on request.

Fourniture dans un boitage bois : prix sur demande.

Se entrega en una caja de madera: precio bajo presupuesto.

LIMESTONE
LIMESTONE ANTISLIP



STONES

224

revigres

LIMESTONE SAND _ LIMESTONE MIST _ RULE SMOG



STONES

225

revigres

GRID HONEY _ LIMESTONE MIST _ LIMESTONE SAND

LIMESTONE - LIMESTONE ANTISLIP



LIMESTONE MIST

3121215V21	29,5x59,2x0,98 cm	RECT	P91
312D135V21	59,2x59,2x0,98 cm	ANTISLIP RECT	P91
3121135V21	59,2x59,2x0,98 cm	RECT	P91
3121D35V21	59,2x118,6x0,98 cm	RECT	P109
3121H85V21	44,35x88,9x1,05 cm	RECT	P94
3121K75V21	88,9x88,9x1,05 cm	RECT	P109
NEW 3021X35V21	119,8x119,8x0,90 cm	RECT	P120
NEW 302DX35V21	119,8x119,8x0,90 cm	ANTISLIP RECT	P120



LIMESTONE SAND

3121215V31	29,5x59,2x0,98 cm	RECT	P91
312D135V31	59,2x59,2x0,98 cm	ANTISLIP RECT	P91
3121135V31	59,2x59,2x0,98 cm	RECT	P91
3121D35V31	59,2x118,6x0,98 cm	RECT	P109
3121H85V31	44,35x88,9x1,05 cm	RECT	P94
3121K75V31	88,9x88,9x1,05 cm	RECT	P109
NEW 3021X35V31	119,8x119,8x0,90 cm	RECT	P120
NEW 302DX35V31	119,8x119,8x0,90 cm	ANTISLIP RECT	P120



LIMESTONE ANTIQUE MIST (b)

3121660W61	9,7x59,2x0,85 cm	RECT	P09 /peça_pieza
------------	------------------	------	-----------------



LIMESTONE ANTIQUE SAND (b)

3121660W71	9,7x59,2x0,85 cm	RECT	P09 /peça_pieza
------------	------------------	------	-----------------



29,5x59,2 · 59,2x118,6 · 88,9x88,9 cm	RECT	V2	5	class 2	B	R10	36+	≥0,42	U4P3E3C2
59,2x59,2 · 44,35x88,9 cm	RECT	V2	5	class 2	B	R10	36+	≥0,42	U4P4E3C2
59,2x59,2 cm	ANTISLIP RECT	V2	5	class 3	C	R11	36+	≥0,42	-
119,8x119,8 cm	RECT	V2	4	class 2	B	R10	36+	≥0,42	-
119,8x119,8 cm	ANTISLIP RECT	V2	4	class 3	C	R11	36+	≥0,42	-

Antislip: Produtos que minimizam o risco de deslizamento.
Antislip: Products that minimize the risk of slipping.
Antislip: Produits qui réduisent le risque de glissement.
Antislip: Productos que minimizan el riesgo de deslizamiento.

Tendo em vista alcançar um efeito global mais real e harmonioso, são produzidas peças diferentes umas das outras com variações de desenho e/ou cores entre elas.
 For a more genuine and harmonious effect overall, different tiles with design and/or colour variations are produced.
 Afin d'obtenir un effet global plus réel et harmonieux, nos pièces sont différentes les unes des autres avec des variations de dessin et / ou de nuances entre elles.
 Para lograr un efecto global más real y armonioso, se producen piezas diferentes unas de otras con variaciones de diseño y/o color.

LIMESTONE - LIMESTONE ANTISLIP



PEÇAS · PIECES		±	CAIXA · BOX			EUROPALETE · EUROPALLET		
			PZ	M ²	KG	CX	M ²	KG
29,5x59,2 cm	RECT	8,5 ±5%	8	1.40	28.8	32	44.80	943
59,2x59,2 cm	RECT · ANTISLIP RECT	8,5 ±5%	4	1.40	28.7	32	44.80	1053
44,35x88,9 cm	RECT	10,5 ±5mm	4	1.58	39.0	24	37.92	991
88,9x88,9 cm	RECT	10,5 ±5mm	2	1.58	39.0	24	37.92	991
59,2x118,6 cm	RECT	9,8 ±5%	2	1.40	33.0	30	42.00	1011
119,8x119,8 cm	RECT · ANTISLIP	9,0 ±5%	1	1.44	28.1	32	46.08	959.2
119,8x277,8 cm	RECT	6,0 ±5%	1	3.33	50.4	18	59.94	1019

PEÇA · PIECE		PEÇA · PIECE		PEÇA · PIECE		PEÇA · PIECE		PEÇA · PIECE	
DG	RECT	RB	RECT	DG CF	RECT	DG CF SS	RECT	DG CF CANTO	RECT
	ANTISLIP RECT		ANTISLIP RECT		ANTISLIP RECT		ANTISLIP RECT		ANTISLIP RECT
29,5x59,2 cm	P18	9,5x29,5 cm	P08	29,5x59,2 cm	P157	29,5x59,2 cm	P157	29,5x59,2 cm	P207
59,2x59,2 cm	P36	8x44,35 cm	P16						
44,35x88,9 cm	P96	8x59,2 cm	P12						
29,5x118,6 cm	P96	8x88,9 cm	P28						
59,2x118,6 cm	P167	8x118,6 cm	P28						

DG CF / DG CF Canto/DG CF SS: Peças produzidas sob encomenda. Altura do focinho: entre 3 cm e 10 cm. Indicar a altura pretendida no ato da encomenda.
 DG CF / DG CF Canto/DG CF SS: Pieces produced on order. Trim height: 3 to 10 cm. Specify desired height when placing a order.
 DG CF / DG CF Canto/DG CF SS: Pièces produites sur commande. Hauteur du nez de marche : entre 3 cm et 10 cm. Préciser la hauteur souhaitée lors de la commande.
 DG CF / DG CF Canto/DG CF SS: Piezas producidas por encargo. Altura del ángulo: entre 3 y 10 cm. Indicar la altura deseada al realizar el pedido.

DG CF Canto: Disponível em canto esquerdo e direito.
 DG CF Canto: Available in left and right corner.
 DG CF Canto: Disponible en angle gauche et droit.
 DG CF Canto: Canto izquierdo y derecho disponibles.



LIMESTONE ANTIQUE SAND

LINEA 2	LINEA 4	LINEA 8
29,5x29,5 29,5x59,2	29,5x29,5 29,5x59,2	29,5x29,5 29,5x59,2

Pág. 44

STONES

TRAVERTINO CLASSIC



2 cores
colours
couleurs
colores

3 formatos
formats
formats
formatos

1 acabamento
finish
 finition
acabado

Com a tecnologia Tech 3D de impressão digital de última geração, a gráfica e texturas dos materiais cerâmicos convergem na perfeição, conferindo um efeito sensorial ultrarrealista inspirado na pedra natural travertino.

Thanks to state-of-the-art Tech 3D digital printing, the graphics and textures of ceramic materials converge perfectly for an ultra-realistic sensory effect inspired by the Travertine natural stone.

Avec la technologie Tech 3D d'impression numérique de dernière génération, les graphismes et les textures des matériaux céramiques convergent à la perfection, en conférant un effet sensoriel ultraréaliste inspiré de la pierre naturelle travertin.

Con la tecnología de impresión digital de última generación Tech 3D, los gráficos y las texturas de los materiales cerámicos convergen a la perfección, aportando un efecto sensorial ultrarrealista inspirado en la piedra natural travertino.

59,2x118,6 cm
(23"x47")

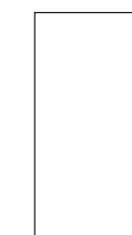

88,9x88,9 cm
(35"x35")



59,2x59,2 cm
(23"x23")

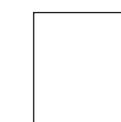

MATT RECT

16

Até 16 desenhos
Up to 16 designs
Jusqu'à 16 dessins
Hasta 16 diseños

Offwhite

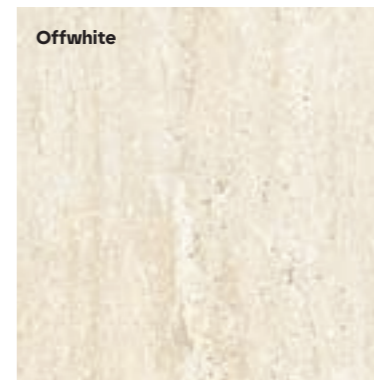

Sand



TRAVERTINO CLASSIC SAND

TRAVERTINO CLASSIC



TRAVERTINO CLASSIC OFFWHITE

31211380V1	59,2x59,2x0,98 cm	MATT RECT	P91
3121K780V1	88,9x88,9x1,05 cm	MATT RECT	P109
3121D380V1	59,2x118,6x0,98 cm	MATT RECT	P109

TRAVERTINO CLASSIC SAND

31211381V1	59,2x59,2x0,98 cm	MATT RECT	P91
3121K781V1	88,9x88,9x1,05 cm	MATT RECT	P109
3121D381V1	59,2x118,6x0,98 cm	MATT RECT	P109



59,2x59,2 · 88,9x88,9 · 59,2x118,6 cm	MATT RECT	V3	3	class 2	B	R10	36+	≥0,42
---------------------------------------	-----------	----	---	---------	---	-----	-----	-------



Com a tecnologia TECH 3D de impressão digital de última geração, a Revigrés introduz superfícies inovadoras, em que a gráfica e texturas dos materiais cerâmicos convergem na perfeição, conferindo-lhes um efeito sensorial ultrarrealista.

Thanks to state-of-the-art TECH 3D digital printing technology, Revigrés introduces innovative tiles, where the graphics and textures of ceramic materials converge perfectly, conveying an ultra-realistic sensory.

Avec la technologie Tech 3D d'impression numérique de dernière génération, Revigrés introduit des surfaces innovantes, où les graphismes et les textures des matériaux céramiques convergent à la perfection, en leur conférant un effet sensoriel ultraréaliste.

Con la tecnología de impresión digital de última generación Tech 3D, Revigrés introduce superficies innovadoras, en las que los gráficos y las texturas de los materiales cerámicos convergen a la perfección, aportándoles un efecto sensorial ultrarrealista.

TRAVERTINO CLASSIC

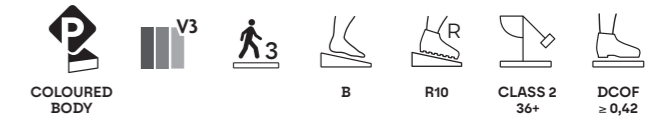

PEÇAS · PIECES			CAIXA · BOX			EUROPALETE · EUROPALLET		
		±	PZ	M ²	KG	CX	M ²	KG
59,2x59,2 cm	MATT RECT	9,8 ±5%	4	1.40	28.7	32	50.40	1053
88,9x88,9 cm	MATT RECT	10,5 ±5mm	2	1.58	39.0	24	37.92	956
59,2x118,6 cm	MATT RECT	9,8 ±5%	2	1.40	32.20	30	42.00	987

PEÇA · PIECE		PEÇA · PIECE		PEÇA · PIECE		PEÇA · PIECE		PEÇA · PIECE	
DG	MATT RECT	RB	MATT RECT	DG CF	MATT RECT	DG CF SS	MATT RECT	DG CF CANTO	MATT RECT
29,5x59,2 cm	P18	9,5x29,5 cm	P08	29,5x59,2 cm	P157	29,5x59,2 cm	P157	29,5x59,2 cm	P207
59,2x59,2 cm	P36	8x44,35 cm	P16						
44,35x88,9 cm	P96	8x59,2 cm	P12						
29,5x118,6 cm	P96	8x88,9 cm	P28						
59,2x118,6 cm	P167	8x118,6 cm	P28						

DG CF / DG CF Canto/DG CF SS: Peças produzidas sob encomenda. Altura do flocinho: entre 3 cm e 10 cm. Indicar a altura pretendida no ato da encomenda.

DG CF / DG CF Canto/DG CF SS: Pieces produced on order. Trim height: 3 to 10 cm. Specify desired height when placing a order.

DG CF / DG CF Canto/DG CF SS: Pièces produites sur commande. Hauteur du nez de marche : entre 3 cm et 10 cm. Préciser la hauteur souhaitée lors de la commande.

DG CF / DG CF Canto/DG CF SS: Piezas producidas por encargo. Altura del ángulo: entre 3 y 10 cm. Indicar la altura deseada al realizar el pedido.

DG CF Canto: Disponível em canto esquerdo e direito.

DG CF Canto: Available in left and right corner.

DG CF Canto: Disponible en angle gauche et droit.

DG CF Canto: Canto izquierdo y derecho disponibles.

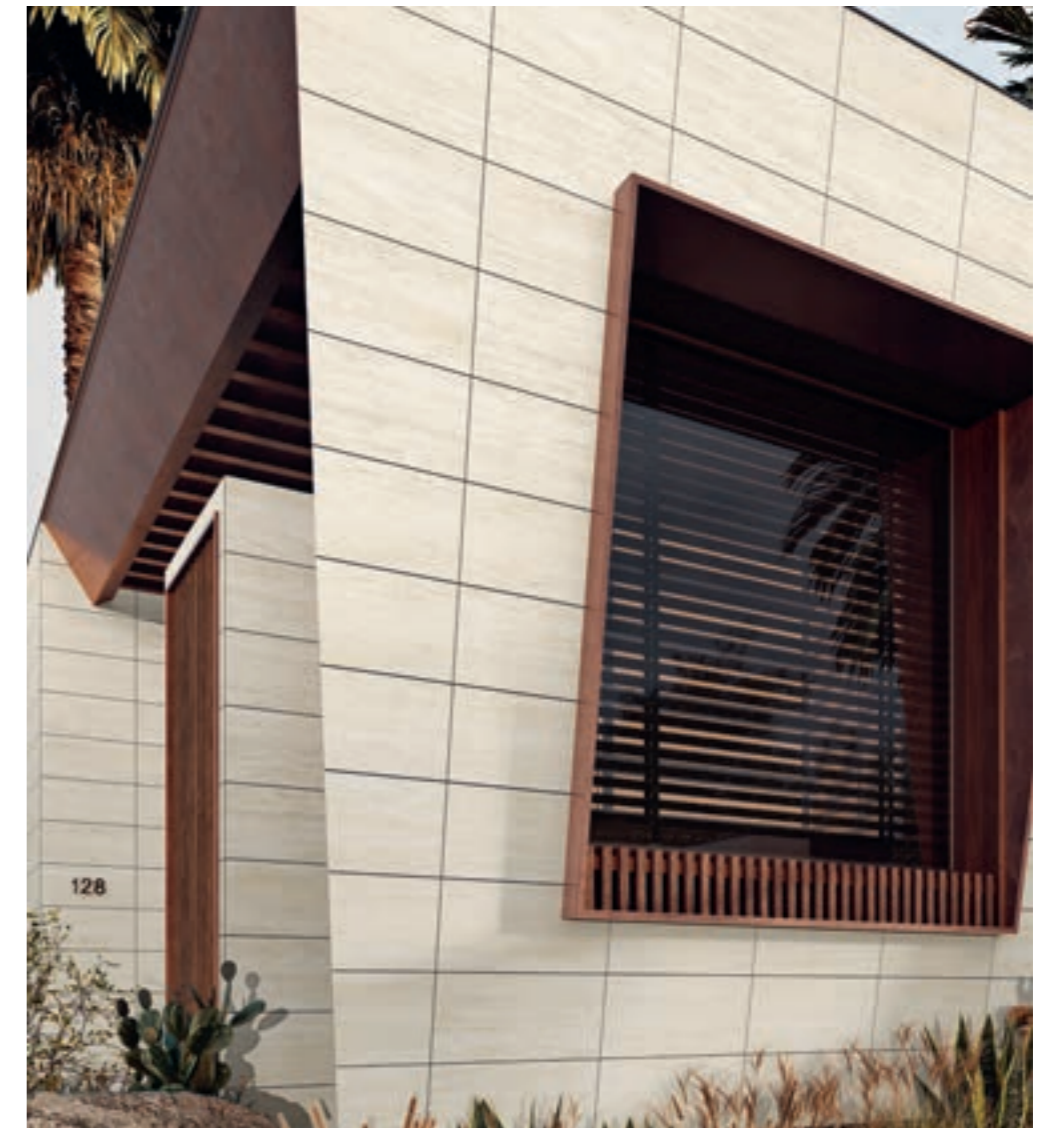

TRAVERTINO CLASSIC OFFWHITE

Tendo em vista alcançar um efeito global mais real e harmonioso, são produzidas peças diferentes umas das outras com variações de desenho e/ou cores entre elas.

For a more genuine and harmonious effect overall, different tiles with design and/or colour variations are produced.

Afin d'obtenir un effet global plus réel et harmonieux, nos pièces sont différentes les unes des autres avec des variations de dessin et / ou de nuances entre elles.

Para lograr un efecto global más real y armonioso, se producen piezas diferentes unas de otras con variaciones de diseño y/o color.



LAVASTONE FOG _ JINKO ÁMBAR

STONES

LAVASTONE



6 cores
colours
couleurs
colores

5 formatos
formats
formats
formatos

2 acabamentos
finishes
finitions
acabados

A reinterpretação dos minerais da pedra natural para espaços sofisticados.

The reinterpretation of natural minerals for sophisticated spaces.

La réinterprétation des minéraux de la pierre naturelle pour les espaces sophistiqués.

La reinterpretación de los minerales de la piedra natural para espacios sofisticados.

59,2x118,6 cm (23"x47")

88,9x88,9 cm (35"x35")

44,35x88,9 cm (18"x35")

59,2x59,2 cm (23"x23")

29,5x59,2 cm (12"x23")

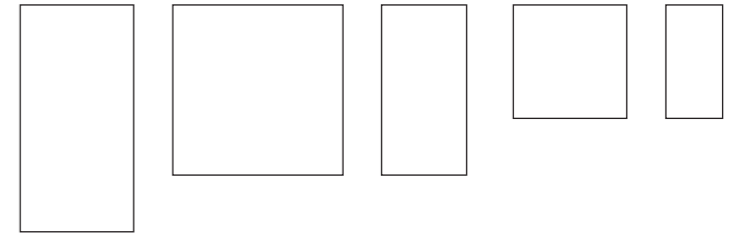

SOFT · ANTISLIP RECT

12

Até 12 desenhos
Up to 12 designs
Jusqu'à 12 dessins
Hasta 12 diseños

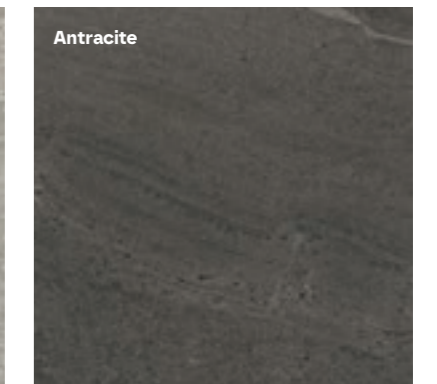
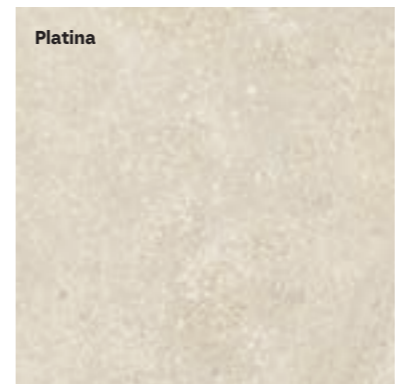
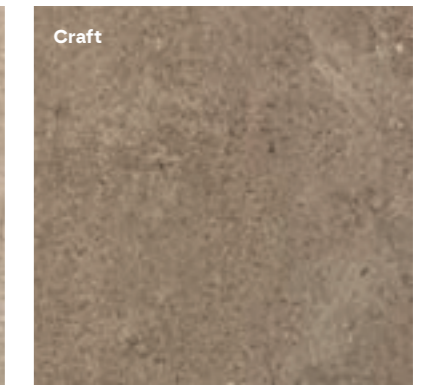
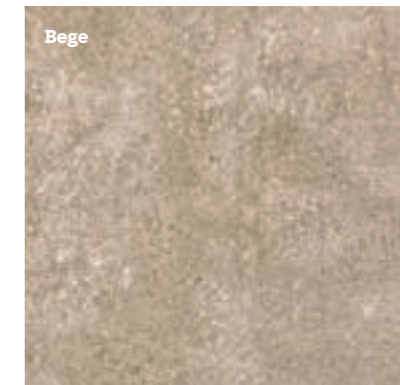

LAVASTONE _ LAVASTONE ANTISLIP



LAVASTONE FOG _ LAVASTONE FOG ANTISLIP

MORADIA BICESSE - ESTORIL, PORTUGAL
PRIVATE HOUSE "BICESSE" - ESTORIL, PORTUGAL

LAVASTONE _ LAVASTONE ANTISLIP

O TECH 20 mm é ideal para jardins, parques, terraços e espaços privados ou públicos de alto tráfego. Através da aplicação a seco, pode ser colocado sobre gravilha, relva, superfícies irregulares e pavimentos técnicos sobreelevados. De fácil e rápida aplicação, é ainda removível.

Com cimento cola, representa um produto de altíssima resistência mecânica, sendo adequado para garagens, espaços comerciais ou industriais. A solução ideal para combinar pavimento interior e exterior.

TECH 20 mm is perfect for gardens, parks, terraces and private or heavy-duty public spaces. Through dry application, it can be laid on gravel, grass, uneven surfaces and raised floor. Easy and quick to install, and easily removable.

Laid with adhesive cement the tiles acquire very high mechanical strength; perfect for garages, commercial or industrial spaces. The ideal solution for combining indoor and outdoor flooring.

TECH 20 mm est idéal pour les jardins, les parcs, les terrasses et les espaces privés ou publics à fort trafic. Grâce à la pose à sec, il peut être posé sur du gravier, du gazon, des surfaces irrégulières et des planchers techniques surélevés. Facile et rapide à poser, il est également amovible.

Avec le ciment-colle, il représente un produit de très haute résistance mécanique, approprié pour les garages, les espaces commerciaux ou industriels. La solution idéale pour combiner les sols intérieurs et extérieurs.

TECH 20 mm es ideal para jardines, parques, terrazas y espacios privados o públicos con mucho tráfico. Si se aplica en seco, se puede colocar sobre gravilla, hierba, superficies irregulares y pavimentos técnicos elevados. Ofrece una aplicación fácil y rápida, además de ser removible.

Si se aplica con cemento cola, es un producto con una altísima resistencia mecánica, lo que lo hace adecuado para garajes, espacios comerciales o industriales. La solución ideal para combinar pavimento interior y exterior.



LAVASTONE PLATINA 20 mm _ RULE ALLOY

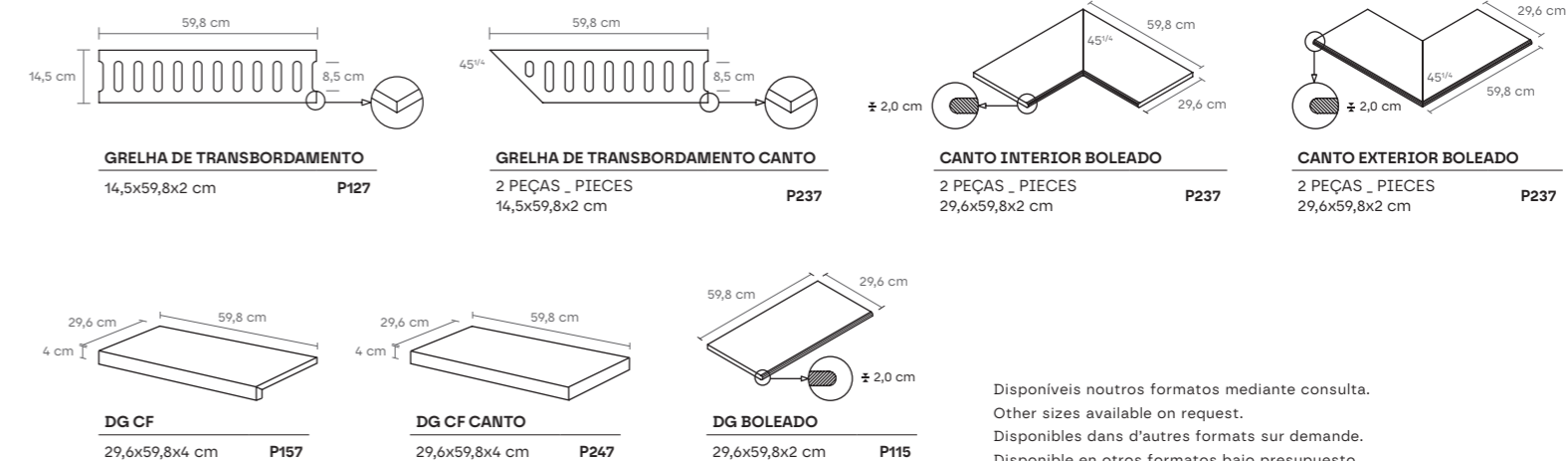

LAVASTONE _ LAVASTONE ANTISLIP



LAVASTONE PLATINA

312D2130T1	29,5x59,2x0,85 cm	ANTISLIP RECT	P91
31252130T1	29,5x59,2x0,85 cm	SOFT	P91
312D1330T1	59,2x59,2x0,85 cm	ANTISLIP RECT	P91
31251330T1	59,2x59,2x0,85 cm	SOFT	P91
312DH830T1	44,35x88,9x1,05 cm	ANTISLIP RECT	P94
3125H830T1	44,35x88,9x1,05 cm	SOFT	P94
312DK730T1	88,9x88,9x1,05 cm	ANTISLIP RECT	P109
3125K730T1	88,9x88,9x1,05 cm	SOFT	P109
312DD330T1	59,2x118,6x0,98 cm	ANTISLIP RECT	P109
3126D330T1	59,2x118,6x0,98 cm	SOFT	P109

LAVASTONE PLATINA **TECH 20 mm**

NEW 302DD351V1	59,8x119,8x2,00 cm	ANTISLIP RECT	P130
-----------------------	--------------------	---------------	------



LAVASTONE BONE

312D2127T1	29,5x59,2x0,85 cm	ANTISLIP RECT	P91
31252127T1	29,5x59,2x0,85 cm	SOFT	P91
312D1327T1	59,2x59,2x0,85 cm	ANTISLIP RECT	P91
31251327T1	59,2x59,2x0,85 cm	SOFT	P91
312DH827T1	44,35x88,9x1,05 cm	ANTISLIP RECT	P94
3125H827T1	44,35x88,9x1,05 cm	SOFT	P94
312DK727T1	88,9x88,9x1,05 cm	ANTISLIP RECT	P109
3125K727T1	88,9x88,9x1,05 cm	SOFT	P109
312DD327T1	59,2x118,6x0,98 cm	ANTISLIP RECT	P109
3126D327T1	59,2x118,6x0,98 cm	SOFT	P109

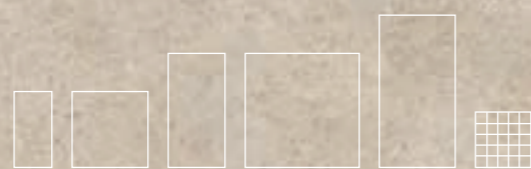

LAVASTONE _ LAVASTONE ANTISLIP



LAVASTONE BEGE

312D2126T1	29,5x59,2x0,85 cm	ANTISLIP RECT	P91
31252126T1	29,5x59,2x0,85 cm	SOFT	P91
312D1326T1	59,2x59,2x0,85 cm	ANTISLIP RECT	P91
31251326T1	59,2x59,2x0,85 cm	SOFT	P91
312DH826T1	44,35x88,9x1,05 cm	ANTISLIP RECT	P94
3125H826T1	44,35x88,9x1,05 cm	SOFT	P94
312DK726T1	88,9x88,9x1,05 cm	ANTISLIP RECT	P109
3125K726T1	88,9x88,9x1,05 cm	SOFT	P109
312DD326T1	59,2x118,6x0,98 cm	ANTISLIP RECT	P109
3126D326T1	59,2x118,6x0,98 cm	SOFT	P109



LAVASTONE CRAFT

312D2128T1	29,5x59,2x0,85 cm	ANTISLIP RECT	P91
31252128T1	29,5x59,2x0,85 cm	SOFT	P91
312D1328T1	59,2x59,2x0,85 cm	ANTISLIP RECT	P91
31251328T1	59,2x59,2x0,85 cm	SOFT	P91
312DH828T1	44,35x88,9x1,05 cm	ANTISLIP RECT	P94
3125H828T1	44,35x88,9x1,05 cm	SOFT	P94
312DK728T1	88,9x88,9x1,05 cm	ANTISLIP RECT	P109
3125K728T1	88,9x88,9x1,05 cm	SOFT	P109
312DD328T1	59,2x118,6x0,98 cm	ANTISLIP RECT	P109
3126D328T1	59,2x118,6x0,98 cm	SOFT	P109



STONES

STONES



STRATUS 36 (a)(f)

29,5x29,5x0,85 cm **ANTISLIP RECT** P19 /peça_piece
[1m² = 11 peças_pieces]



Produtos que integram alguns materiais reciclados.
Products that incorporate some recycled materials.
Produits intégrant quelques matériaux recyclés.
Productos que incorporan algunos materiales reciclados.

Antislip: Produtos que minimizam o risco de deslizamento.
Antislip: Products that minimize the risk of slipping.
Antislip: Produits qui réduisent le risque de glissement.
Antislip: Productos que minimizan el riesgo de deslizamiento.

revigres



29,5x59,2 · 59,2x59,2 · 44,35x88,9 · 88,9x88,9 cm	ANTISLIP RECT	V4	5	class 3	B	R11	36+	≥0,42	U4P3E3C2
29,5x59,2 · 59,2x59,2 · 44,35x88,9 · 88,9x88,9 · 59,2x118,6 cm	SOFT	V4	3	-	-	-	-	-	-
59,2x118,6 cm	ANTISLIP RECT	V4	5	class 3	B	R11	36+	≥0,42	-
59,8x119,8 cm 20 mm	ANTISLIP RECT	V4	4	class 3	C	R11	36+	≥0,42	-

revigres

LAVASTONE - LAVASTONE ANTISLIP



LAVASTONE FOG

312D2129T1	29,5x59,2x0,85 cm	ANTISLIP RECT	P91
312S2129T1	29,5x59,2x0,85 cm	SOFT	P91
312D1329T1	59,2x59,2x0,85 cm	ANTISLIP RECT	P91
312S1329T1	59,2x59,2x0,85 cm	SOFT	P91
312DH829T1	44,35x88,9x1,05 cm	ANTISLIP RECT	P94
312SH829T1	44,35x88,9x1,05 cm	SOFT	P94
312DK729T1	88,9x88,9x1,05 cm	ANTISLIP RECT	P109
312SK729T1	88,9x88,9x1,05 cm	SOFT	P109
312DD329T1	59,2x118,6x0,98 cm	ANTISLIP RECT	P109
3126D329T1	59,2x118,6x0,98 cm	SOFT	P109

LAVASTONE FOG TECH 20 mm

NEW 302DD352V1	59,8x119,8x2,00 cm	ANTISLIP RECT	P130
----------------	--------------------	---------------	------

LAVASTONE ANTRACITE

312D2125T1	29,5x59,2x0,85 cm	ANTISLIP RECT	P91
312S2125T1	29,5x59,2x0,85 cm	SOFT	P91
312D1325T1	59,2x59,2x0,85 cm	ANTISLIP RECT	P91
312S1325T1	59,2x59,2x0,85 cm	SOFT	P91
312DH825T1	44,35x88,9x1,05 cm	ANTISLIP RECT	P94
312SH825T1	44,35x88,9x1,05 cm	SOFT	P94
312DK725T1	88,9x88,9x1,05 cm	ANTISLIP RECT	P109
312SK725T1	88,9x88,9x1,05 cm	SOFT	P109
312DD325T1	59,2x118,6x0,98 cm	ANTISLIP RECT	P109
3126D325T1	59,2x118,6x0,98 cm	SOFT	P109



STRATUS 36 (a)(f)

29,5x29,5x0,85 cm ANTISLIP RECT P19 /peça_piece

[1m² = 11 peças_pieces]



29,5x59,2 · 59,2x59,2 · 44,35x88,9 · 88,9x88,9 cm	ANTISLIP RECT	V4	5	class 3	B	R11	36+	≥0,42	U4P3E3C2
29,5x59,2 · 59,2x59,2 · 44,35x88,9 · 88,9x88,9 · 59,2x118,6 cm	SOFT	V4	3	-	-	-	-	-	-
59,2x118,6 cm	ANTISLIP RECT	V4	5	class 3	B	R11	36+	≥0,42	-
59,8x119,8 cm 20 mm	ANTISLIP RECT	V4	4	class 3	C	R11	36+	≥0,42	-

LAVASTONE - LAVASTONE ANTISLIP



PEÇAS · PIECES	CAIXA · BOX	EUROPALETE · EUROPALLET					
		PZ	M²	KG			
29,5x59,2 cm ANTISLIP RECT · SOFT	8,5 ±5%	8	1.40	28.80	32	44.80	943
59,2x59,2 cm ANTISLIP RECT · SOFT	8,5 ±5%	4	1.40	28.70	36	50.40	1 053
44,35x88,9 cm ANTISLIP RECT · SOFT	10,5 ±5mm	4	1.58	39.00	24	37.92	991
88,9x88,9 cm ANTISLIP RECT · SOFT	10,5 ±5mm	2	1.58	39.00	24	37.92	991
59,2x118,6 cm ANTISLIP RECT · SOFT	9,8 ±5%	2	1.40	33.00	30	42.00	1 011
59,8x119,8 cm ANTISLIP RECT	20,0 ±5mm	1	0.72	31.04	36	25.92	1 119.74

PEÇA · PIECE	PEÇA · PIECE	PEÇA · PIECE	PEÇA · PIECE	PEÇA · PIECE
DG SOFT ANTISLIP RECT	RB SOFT ANTISLIP RECT	DG CF SOFT ANTISLIP RECT	DG CF SS SOFT ANTISLIP RECT	DG CF CANTO SOFT ANTISLIP RECT
29,5x59,2 cm P18	9,5x29,5 cm P08	29,5x59,2 cm P157	29,5x59,2 cm P157	29,5x59,2 cm P207
59,2x59,2 cm P36	8x44,35 cm P16			
44,35x88,9 cm P96	8x59,2 cm P12			
29,5x118,6 cm P96	8x88,9 cm P28			
59,2x118,6 cm P167	8x118,6 cm P28			

DG CF / DG CF Canto/DG CF SS: Peças produzidas sob encomenda. Altura do flocinho: entre 3 cm e 10 cm. Indicar a altura pretendida no ato da encomenda.

DG CF / DG CF Canto/DG CF SS: Pieces produced on order. Trim height: 3 to 10 cm. Specify desired height when placing a order.

DG CF / DG CF Canto/DG CF SS: Pièces produites sur commande. Hauteur du nez de marche : entre 3 cm et 10 cm. Préciser la hauteur souhaitée lors de la commande.

DG CF / DG CF Canto/DG CF SS: Piezas producidas por encargo. Altura del ángulo: entre 3 y 10 cm. Indicar la altura deseada al realizar el pedido.

DG CF Canto: Disponível em canto esquerdo e direito.
DG CF Canto: Available in left and right corner.
DG CF Canto: Disponible en angle gauche et droit.
DG CF Canto: Canto izquierdo y derecho disponibles.

Produtos que integram alguns materiais reciclados.
Products that incorporate some recycled materials.
Produits intégrant quelques matériaux recyclés.
Productos que incorporan algunos materiales reciclados.

Antislip: Produtos que minimizam o risco de deslizamento.
Antislip: Products that minimize the risk of slipping.
Antislip: Produits qui réduisent le risque de glissement.
Antislip: Productos que minimizan el riesgo de deslizamiento.





DI ALBA STONE GREY _ DI ALBA STONE CARBON _ BRICK GREEN GLOSSY

STONES

DI ALBA STONE



2 cores colours couleurs colores 7 formatos formats formats 2 acabamentos finishes finitions acabados

Arrojados movimentos de tons e de efeitos, estilizados nesta pedra natural da Albânia.

Bold movements of shades and effects, stylized in this natural Albanian stone.

Des mouvements osée de tonalités et d'effets, stylisés dans cette pierre naturelle albanaise.

Atrevidos movimientos de tonos y efectos, estilizados en esta piedra natural de Albania.

59,2x118,6 cm (23"x47") 88,9x88,9 cm (35"x35") 44,35x88,9 cm (18"x35") 59,2x59,2 cm (23"x23") 29,5x59,2 cm (12"x23")

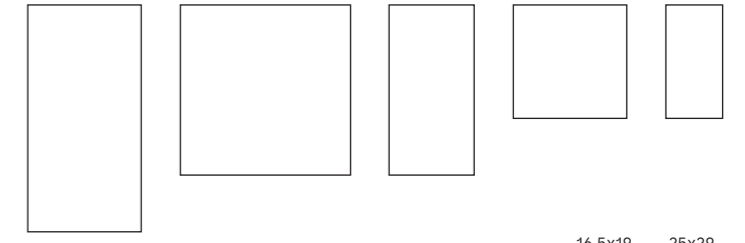

16,5x19 (6"x7") 25x29 (10"x11")

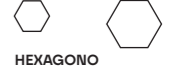

HEXAGONO



RECT · ANTISLIP RECT

13
Até 13 desenhos
Up to 13 designs
Jusqu'à 13 dessins
Hasta 13 diseños

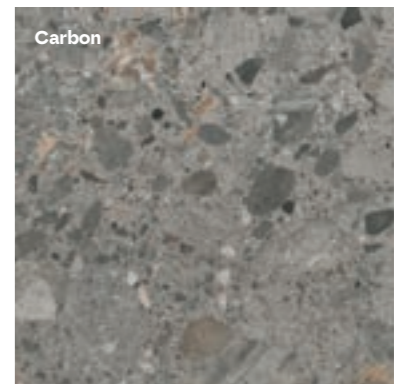
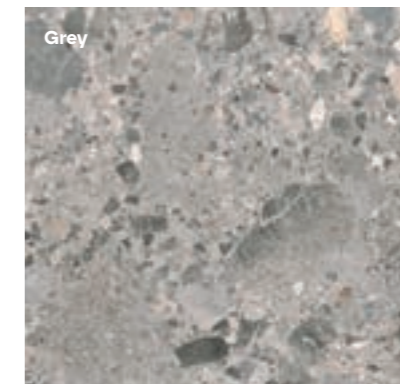

DI ALBA STONE



STONES

STONES

242

243

revigres

revigres

DI ALBA STONE _ DI ALBA STONE ANTISLIP

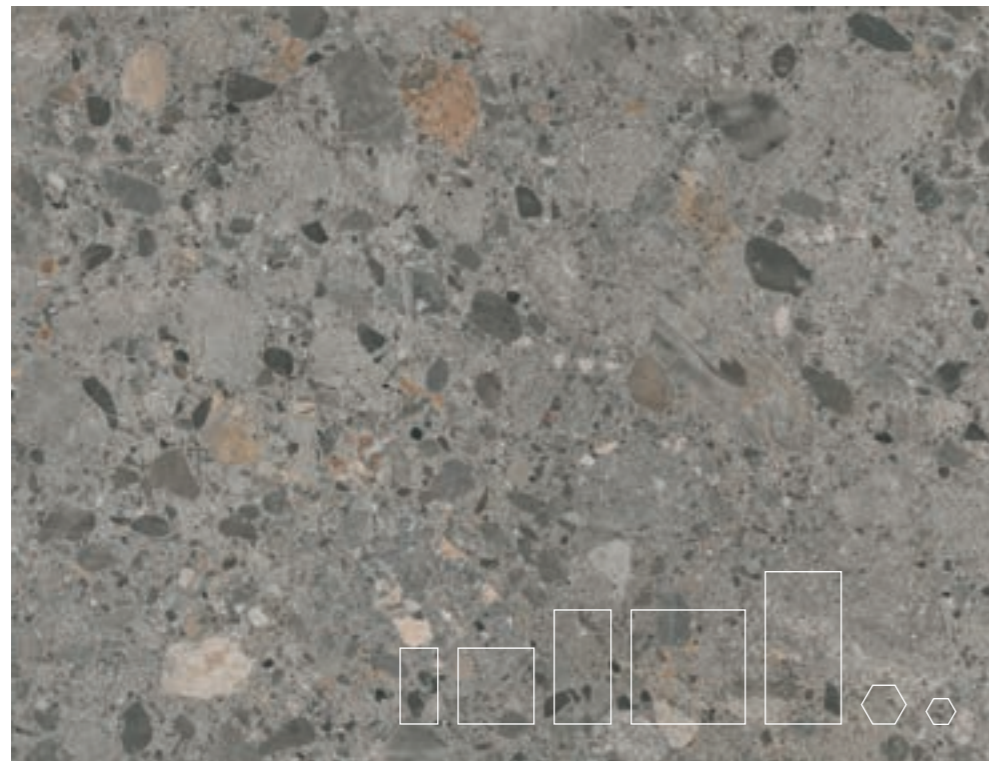

DI ALBA STONE GREY

3121215V61	29,5x59,2x0,85 cm	RECT	P91
312D135V61	59,2x59,2x0,85 cm	ANTISLIP RECT	P91
3121135V61	59,2x59,2x0,85 cm	RECT	P91
3121D35V61	59,2x118,6x0,98 cm	RECT	P109
3121H85V61	44,35x88,9x1,05 cm	RECT	P94
3121K75V61	88,9x88,9x1,05 cm	RECT	P109

HEXAGONO DI ALBA STONE GREY

33213A8V41	25,1x29x0,85 cm (*)	RECT	P215
3321V38V41	16,5x19x0,85 cm	RECT	P293

DI ALBA STONE CARBON

3121215V71	29,5x59,2x0,85 cm	RECT	P91
312D135V71	59,2x59,2x0,85 cm	ANTISLIP RECT	P91
3121135V71	59,2x59,2x0,85 cm	RECT	P91
3121D35V71	59,2x118,6x0,98 cm	RECT	P109
3121H85V71	44,35x88,9x1,05 cm	RECT	P94
3121K75V71	88,9x88,9x1,05 cm	RECT	P109

HEXAGONO DI ALBA CARBON

33213A8V31	25,1x29x0,85 cm (*)	RECT	P215
3321V38V31	16,5x19x0,85 cm	RECT	P293

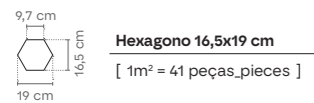
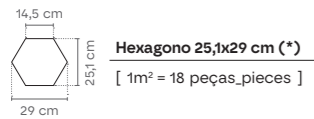

29,5x59,2 · 59,2x118,6 · 88,9x88,9 · 25,1x29 cm	RECT	V3	5	class 2	B	R10	36+	≥0,42	U4P3E3C2
59,2x59,2 · 44,35x88,9 cm	RECT	V3	5	class 2	B	R10	36+	≥0,42	U4P4E3C2
59,2x59,2 cm	ANTISLIP RECT	V3	5	class 3	C	R11	36+	≥0,42	-



(*) Peças produzidas de acordo com quantidades mínimas de 10m².
 (*) Pieces produced in minimum quantities of 10m².
 (*) Pièces produites selon des quantités minimales de 10m².
 (*) Piezas producidas en cantidades mínimas de 10m².

DI ALBA STONE _ DI ALBA STONE ANTISLIP



PEÇAS · PIECES		CAIXA · BOX			EUROPALETE · EUROPALLET		
		PZ	M²	KG	CX	M²	KG
16,5x19 cm	RECT	6	0,15	3,50	106	15,90	392
25,1x29 cm	RECT	12	0,67	15,00	30	20,02	471
29,5x59,2 cm	RECT	8	1,40	28,80	32	44,80	943
59,2x59,2 cm	RECT · ANTISLIP RECT	4	1,40	28,70	36	50,40	1 053
44,35x88,9 cm	RECT	4	1,58	39,00	24	37,92	991
88,9x88,9 cm	RECT	2	1,58	39,00	24	37,92	991
59,2x118,6 cm	RECT	2	1,40	33,00	30	42,00	1 011

PEÇA · PIECE		PEÇA · PIECE		PEÇA · PIECE		PEÇA · PIECE		PEÇA · PIECE	
DG	RECT ANTISLIP RECT	RB	RECT ANTISLIP RECT	DG CF	RECT ANTISLIP RECT	DG CF SS	RECT ANTISLIP RECT	DG CF CANTO	RECT ANTISLIP RECT
29,5x59,2 cm	P18	9,5x29,5 cm	P08	29,5x59,2 cm	P157	29,5x59,2 cm	P157	29,5x59,2 cm	P207
59,2x59,2 cm	P36	8x44,35 cm	P16						
44,35x88,9 cm	P96	8x59,2 cm	P12						
29,5x118,6 cm	P96	8x88,9 cm	P28						
59,2x118,6 cm	P167	8x118,6 cm	P28						

DG CF / DG CF Canto/DG CF SS: Peças produzidas sob encomenda. Altura do flocinho: entre 3 cm e 10 cm. Indicar a altura pretendida no ato da encomenda.
 DG CF / DG CF Canto/DG CF SS: Pieces produced on order. Trim height: 3 to 10 cm. Specify desired height when placing a order.
 DG CF / DG CF Canto/DG CF SS: Pièces produites sur commande. Hauteur du nez de marche : entre 3 cm et 10 cm. Préciser la hauteur souhaitée lors de la commande.
 DG CF / DG CF Canto/DG CF SS: Piezas producidas por encargo. Altura del ángulo: entre 3 y 10 cm. Indicar la altura deseada al realizar el pedido.

DG CF Canto: Disponível em canto esquerdo e direito.
 DG CF Canto: Available in left and right corner.
 DG CF Canto: Disponible en angle gauche et droit.
 DG CF Canto: Canto izquierdo y derecho disponibles.

Tendo em vista alcançar um efeito global mais real e harmonioso, são produzidas peças diferentes umas das outras com variações de desenho e/ou cores entre elas.
 For a more genuine and harmonious effect overall, different tiles with design and/or colour variations are produced.
 Afin d'obtenir un effet global plus réel et harmonieux, nos pièces sont différentes les unes des autres avec des variations de dessin et / ou de nuances entre elles.
 Para lograr un efecto global más real y armonioso, se producen piezas diferentes unas de otras con variaciones de diseño y/o color.

LINEA 2	LINEA 4	LINEA 8
29,5x29,5 29,5x59,2	29,5x29,5 29,5x59,2	29,5x29,5 29,5x59,2

Pág. 44



STONES

FRENCH STONE



2 cores colours couleurs colores 5 formatos formats formats 2 acabamentos finishes finitions acabados

Um conluio de tons naturais e movimentos audazes, dão requinte e caráter aos espaços, com assinatura deste calcário francês.

Conlusion of natural colours and bold movements, adds high refinement and character to the spaces, with the signature of this French limestone.

Une collusion de tons naturels et de mouvements audacieux, confèrent un grand raffinement aux espaces, avec la signature de cette pierre calcaire française.

Uma conjura de tonos naturales y movimientos osados del efecto de la piedra caliza francesa aportan refinamiento y carácter a los espacios, con la firma de esta piedra caliza francesa.

59,2x118,6 cm (23"x47") 88,9x88,9 cm (35"x35") 44,35x88,9 cm (18"x35") 59,2x59,2 cm (23"x23") 29,5x59,2 cm (12"x23")

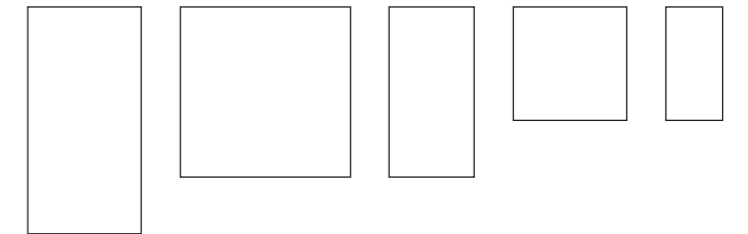

RECT · ANTISLIP RECT

16

Até 16 desenhos
Up to 16 designs
Jusqu'à 16 dessins
Hasta 16 diseños

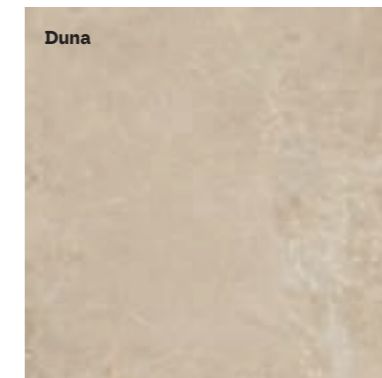

Duna

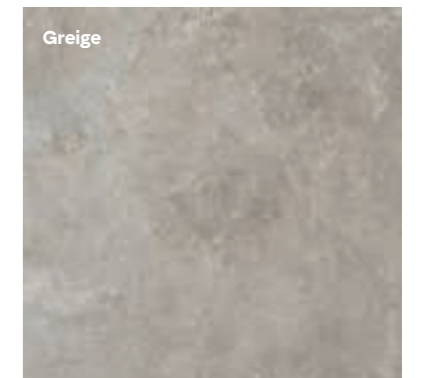

Greige

STONES

246

revigres

FRENCH STONE GREIGE _ DUO 8 XISTO MARFIM

STONES

247

revigres



FRENCH STONE DUNA

3126215V41	29,5x59,2x0,85 cm	RECT	P91
312D135V41	59,2x59,2x0,85 cm	ANTISLIP RECT	P91
3121135V41	59,2x59,2x0,85 cm	RECT	P91
3121D35V41	59,2x118,6x0,98 cm	RECT	P109
3121H85V41	44,35x88,9x1,05 cm	RECT	P94
3121K75V41	88,9x88,9x1,05 cm	RECT	P109



FRENCH STONE GREIGE

3121215V51	29,5x59,2x0,85 cm	RECT	P91
312D135V51	59,2x59,2x0,85 cm	ANTISLIP RECT	P91
3121135V51	59,2x59,2x0,85 cm	RECT	P91
3121D35V51	59,2x118,6x0,98 cm	RECT	P109
3121H85V51	44,35x88,9x1,05 cm	RECT	P94
3121K75V51	88,9x88,9x1,05 cm	RECT	P109



29,5x59,2 · 59,2x118,6 · 88,9x88,9 cm	RECT	V4	5	class 2	B	R10	36+	≥0,42	U4P3E3C2
59,2x59,2 · 44,35x88,9 cm	RECT	V4	5	class 2	B	R10	36+	≥0,42	U4P4E3C2
59,2x59,2 cm	ANTISLIP RECT	V4	5	class 3	C	R11	36+	≥0,42	-



NORDIK WALNUT _ FRENCH STONE ANTIQUE DUNA _ FRENCH STONE DUNA

STONES

STONES

Antislip: Produtos que minimizam o risco de deslizamento.
 Antislip: Products that minimize the risk of slipping.
 Antislip: Produits qui réduisent le risque de glissement.
 Antislip: Productos que minimizan el riesgo de deslizamiento.

Produtos que integram alguns materiais reciclados.
 Products that incorporate some recycled materials.
 Produits intégrant quelques matériaux recyclés.
 Productos que incorporan algunos materiales reciclados.

FRENCH STONE ANTIQUE

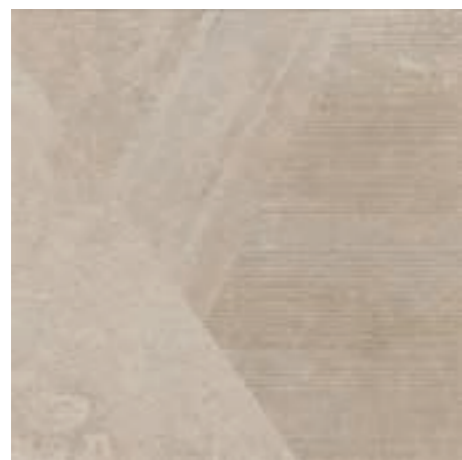

FRENCH STONE ANTIQUE DUNA

3121137V01 59,2x59,2x0,85 cm RECT P94

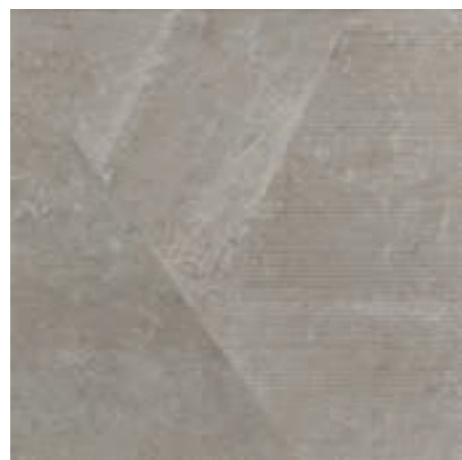

FRENCH STONE ANTIQUE GREIGE

3121137V11 59,2x59,2x0,85 cm RECT P94

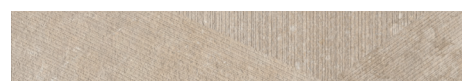

FRENCH STONE ANTIQUE DUNA (**)

3121660W41 9,7x59,2x0,85 cm RECT P09 /peça_pieza

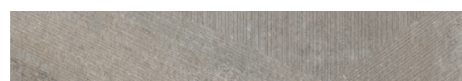

FRENCH STONE ANTIQUE GREIGE (b)

3121660W51 9,7x59,2x0,85 cm RECT P09 /peça_pieza

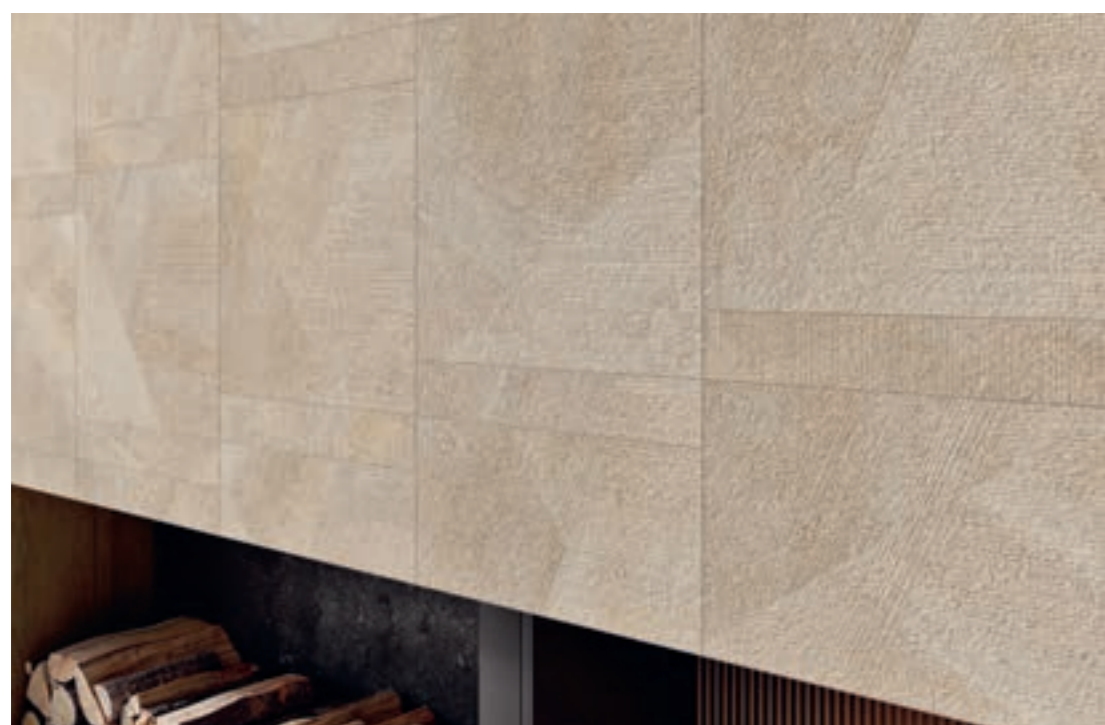

FRENCH STONE ANTIQUE DUNA

FRENCH STONE _ FRENCH STONE ANTISLIP



PEÇAS · PIECES			CAIXA · BOX			EUROPALETE · EUROPALLET		
		±	PZ	M²	KG	CX	M²	KG
29,5x59,2 cm	RECT	8,5 ±5%	8	1.40	28.80	32	44.80	943
59,2x59,2 cm	RECT · ANTISLIP RECT	8,5 ±5%	4	1.40	28.70	36	50.40	1053
44,35x88,9 cm	RECT	10,5 ±5mm	4	1.58	39.00	24	37.92	991
88,9x88,9 cm	RECT	10,5 ±5mm	2	1.58	39.00	24	37.92	991
59,2x118,6 cm	RECT	9,8 ±5%	2	1.40	33.00	30	42.00	1011

PEÇA · PIECE		PEÇA · PIECE		PEÇA · PIECE		PEÇA · PIECE		PEÇA · PIECE	
DG	RECT ANTISLIP RECT	RB	RECT ANTISLIP RECT	DG CF	RECT ANTISLIP RECT	DG CF SS	RECT ANTISLIP RECT	DG CF CANTO	RECT ANTISLIP RECT
29,5x59,2 cm	P18	9,5x29,5 cm	P08	29,5x59,2 cm	P157	29,5x59,2 cm	P157	29,5x59,2 cm	P207
59,2x59,2 cm	P36	8x44,35 cm	P16						
44,35x88,9 cm	P96	8x59,2 cm	P12						
29,5x118,6 cm	P96	8x88,9 cm	P28						
59,2x118,6 cm	P167	8x118,6 cm	P28						

DG CF / DG CF Canto/DG CF SS: Peças produzidas sob encomenda. Altura do fochino: entre 3 cm e 10 cm. Indicar a altura pretendida no ato da encomenda.
 DG CF / DG CF Canto/DG CF SS: Pieces produced on order. Trim height: 3 to 10 cm. Specify desired height when placing a order.
 DG CF / DG CF Canto/DG CF SS: Pièces produites sur commande. Hauteur du nez de marche : entre 3 cm et 10 cm. Préciser la hauteur souhaitée lors de la commande.
 DG CF / DG CF Canto/DG CF SS: Piezas producidas por encargo. Altura del ángulo: entre 3 y 10 cm. Indicar la altura deseada al realizar el pedido.
 DG CF Canto: Disponível em canto esquerdo e direito.
 DG CF Canto: Available in left and right corner.
 DG CF Canto: Disponible en angle gauche et droit.
 DG CF Canto: Canto izquierdo y derecho disponibles.

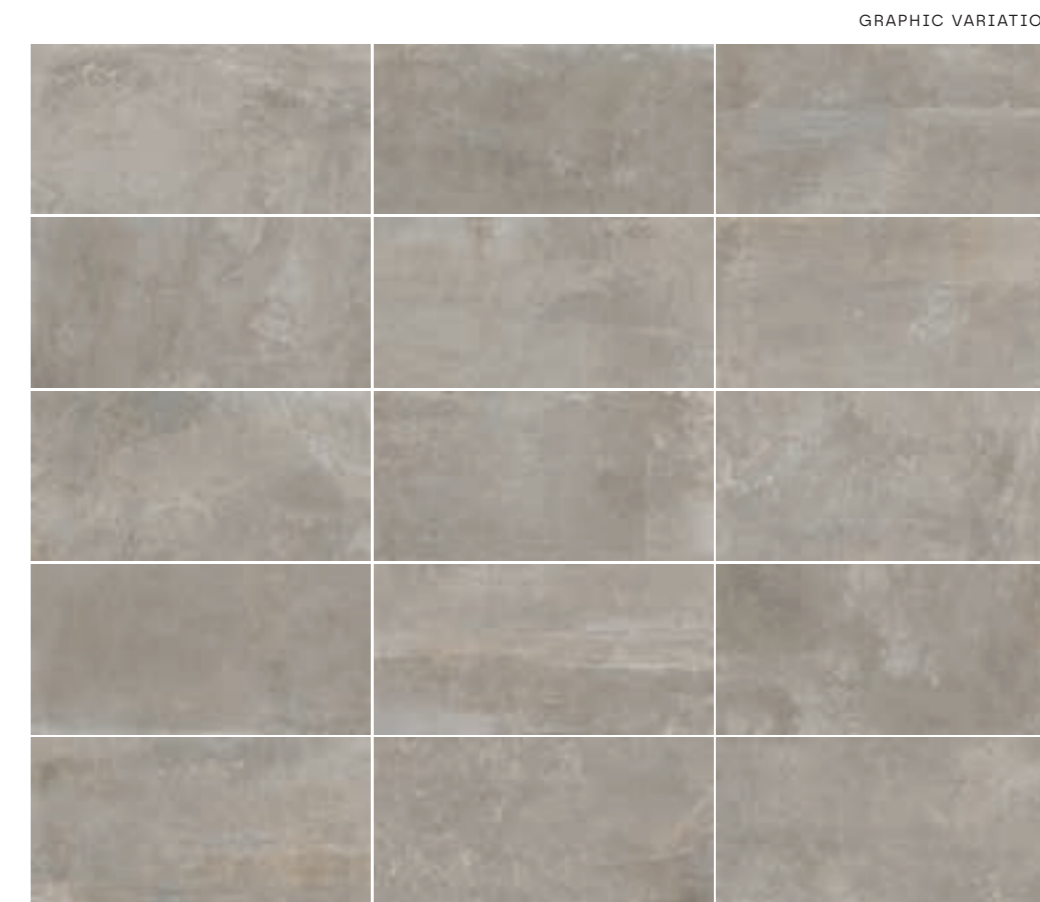

STONES

STONES

250

Produtos que integram alguns materiais reciclados.
 Products that incorporate some recycled materials.
 Produits intégrant quelques matériaux recyclés.
 Productos que incorporan algunos materiales reciclados.



59,2x59,2 cm RECT V4 5 class 2 B R10 36+ ≥0,42

Tendo em vista alcançar um efeito global mais real e harmonioso, são produzidas peças diferentes umas das outras com variações de desenho e/ou cores entre elas.
 For a more genuine and harmonious effect overall, different tiles with design and/or colour variations are produced.
 Afin d'obtenir un effet global plus réel et harmonieux, nos pièces sont différentes les unes des autres avec des variations de dessin et / ou de nuances entre elles.
 Para lograr un efecto global más real y armonioso, se producen piezas diferentes unas de otras con variaciones de diseño y/o color.

LÍNEA 2	LÍNEA 4	LÍNEA 8
29,5x59,2	29,5x59,2	29,5x59,2

Pág. 44

251

revigres

revigres



STONES

SLATE

2 cores
colours
couleurs
colores

4 formatos
formats
formats
formatos

2 acabamentos
finishes
finitions
acabados



Caráter e tecnologia, com o efeito da pedra natural, para ambientes sóbrios, intensos e intemporais.

Character and technology with the natural stone effect for sober, intense and timeless environments.

Caractère et technologie, avec l'effet de la pierre naturelle, pour des ambiances sobres, intenses et intemporelles.

Carácter y tecnología, con el efecto de la piedra natural, para ambientes sobrios, intensos y atemporales.

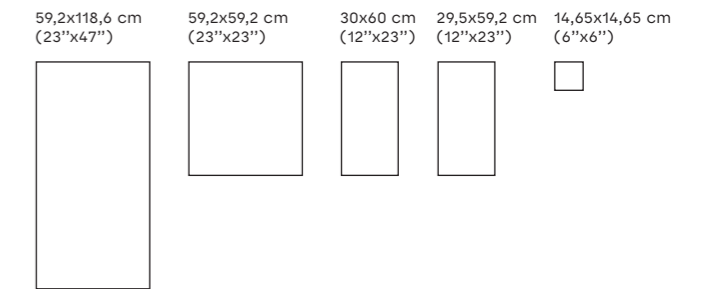

MATT NAT · MATT RECT · **ANTISLIP RECT**

20
Até 20 desenhos
Up to 20 designs
Jusqu'à 20 dessins
Hasta 20 diseños

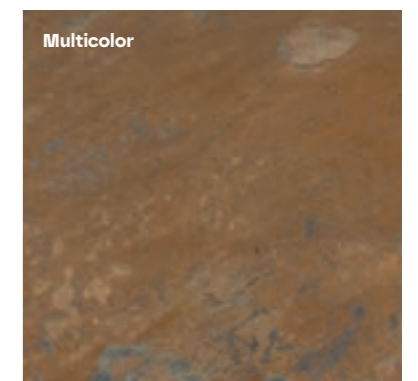
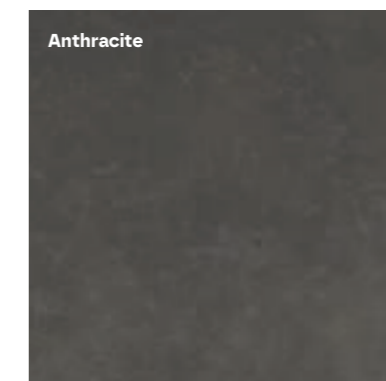



SLATE MULTICOLOR

HABITAÇÃO PRIVADA — FRANÇA
PRIVATE HOUSE — FRANCE



SLATE MULTICOLOR

STONES

STONES

254

255

revigres

revigres

SLATE _ SLATE ANTISLIP

SLATE _ SLATE ANTISLIP



SLATE ANTHRACITE

3121092U41	14,65x14,65x0,85 cm	MATT RECT	P110
3120212U41	30x60x0,85 cm	MATT NAT	P77
3121212U41	29,5x59,2x0,85 cm	MATT RECT	P91
3121132U41	59,2x59,2x0,85 cm	MATT RECT	P91
312D132U81	59,2x59,2x0,85 cm	ANTISLIP RECT	P91
312BD32U41	59,2x118,6x0,98 cm	MATT RECT	P101

SLATE MULTICOLOR

3121092U71	14,65x14,65x0,85 cm	MATT RECT	P110
3120212U71	30x60x0,85 cm	MATT NAT	P77
3121212U71	29,5x59,2x0,85 cm	MATT RECT	P91
312B132U71	59,2x59,2x0,85 cm	MATT RECT	P91
312D133U11	59,2x59,2x0,85 cm	ANTISLIP RECT	P91
312BD32U71	59,2x118,6x0,98 cm	MATT RECT	P101

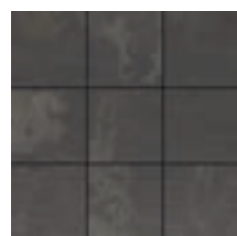

STRATUS 9 SLATE ANTHRACITE (a)(f)

31211227Y1 29,5x29,5x0,85 cm MATT RECT P22 /peça_pieza
[1m² = 11 peças_pieças]

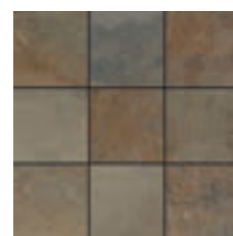

STRATUS 9 SLATE ANTHRACITE (a)(f)

31211230Y1 29,5x29,5x0,85 cm MATT RECT P22 /peça_pieza
[1m² = 11 peças_pieças]

SLATE ANTHRACITE

29,5x59,2 cm	MATT NAT	V3	4	class 2	B	R10	36+	≥0,42
14,65x14,65 · 29,5x59,2 · 59,2x59,2 · 59,2x118,6 cm	MATT RECT	V3	4	class 2	B	R10	36+	≥0,42
59,2x59,2 cm	ANTISLIP RECT	V3	4	class 3	C	R11	36+	≥0,42

SLATE MULTICOLOR

29,5x59,2 cm	MATT NAT	V4	4	class 2	B	R10	36+	≥0,42
14,65x14,65 · 29,5x59,2 · 59,2x59,2 · 59,2x118,6 cm	MATT RECT	V4	4	class 2	B	R10	36+	≥0,42
59,2x59,2 cm	ANTISLIP RECT	V4	4	class 3	C	R12	36+	≥0,42

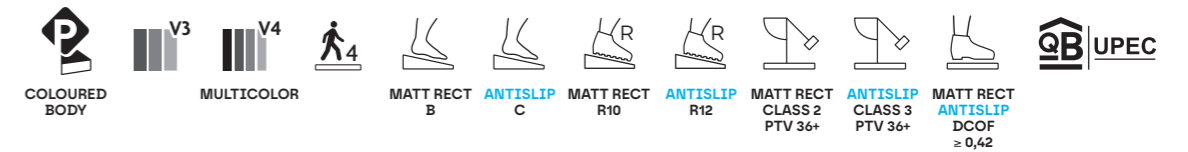

PEÇAS · PIECES			CAIXA · BOX			EUROPALETE · EUROPALLET		
		±	PZ	M²	KG	CX	M²	KG
14,65x14,65 cm	MATT RECT	8,5 ±5%	22	0.47	10.00	112	52.64	1 141
30x60 cm	MATT NAT	8,5 ±5%	8	1.44	28.80	32	46.08	943
29,5x59,2 cm	MATT RECT	8,5 ±5%	8	1.40	28.80	32	44.80	943
59,2x59,2 cm	RECT · ANTISLIP RECT	8,5 ±5%	4	1.40	28.70	36	50.40	1 053
59,2x118,6 cm	RECT	9,8 ±5%	2	1.40	33.00	30	42.00	1 011

PEÇA · PIECE			PEÇA · PIECE			PEÇA · PIECE			PEÇA · PIECE			PEÇA · PIECE		
DG	MATT NAT	MATT RECT ANTISLIP RECT	RB	MATT NAT	MATT RECT ANTISLIP RECT	DG CF	MATT RECT ANTISLIP RECT	DG CF SS	MATT RECT ANTISLIP RECT	DG CF CANTO	MATT RECT ANTISLIP RECT			
29,5x59,2 cm	P12	P18	9,5x29,5 cm	P07	P08	29,5x59,2 cm	P157	29,5x59,2 cm	P157	29,5x59,2 cm	P207			
59,2x59,2 cm	-	P36	8x59,2 cm	P10	P12									
29,5x118,6 cm	-	P96	8x118,6 cm	-	P28									
59,2x118,6 cm	-	P167												

DG CF / DG CF Canto/DG CF SS: Peças produzidas sob encomenda. Altura do flocinho: entre 3 cm e 10 cm. Indicar a altura pretendida no ato da encomenda.
 DG CF / DG CF Canto/DG CF SS: Pièces produites sur commande. Hauteur du nez de marche : entre 3 cm et 10 cm. Préciser la hauteur souhaitée lors de la commande.
 DG CF / DG CF Canto/DG CF SS: Piezas producidas por encargo. Altura del ángulo: entre 3 y 10 cm. Indicar la altura deseada al realizar el pedido.
 DG CF Canto: Disponível em canto esquerdo e direito.
 DG CF Canto: Available in left and right corner.
 DG CF Canto: Disponible en angle gauche et droit.
 DG CF Canto: Canto izquierdo y derecho disponibles.

GRAPHIC VARIATION

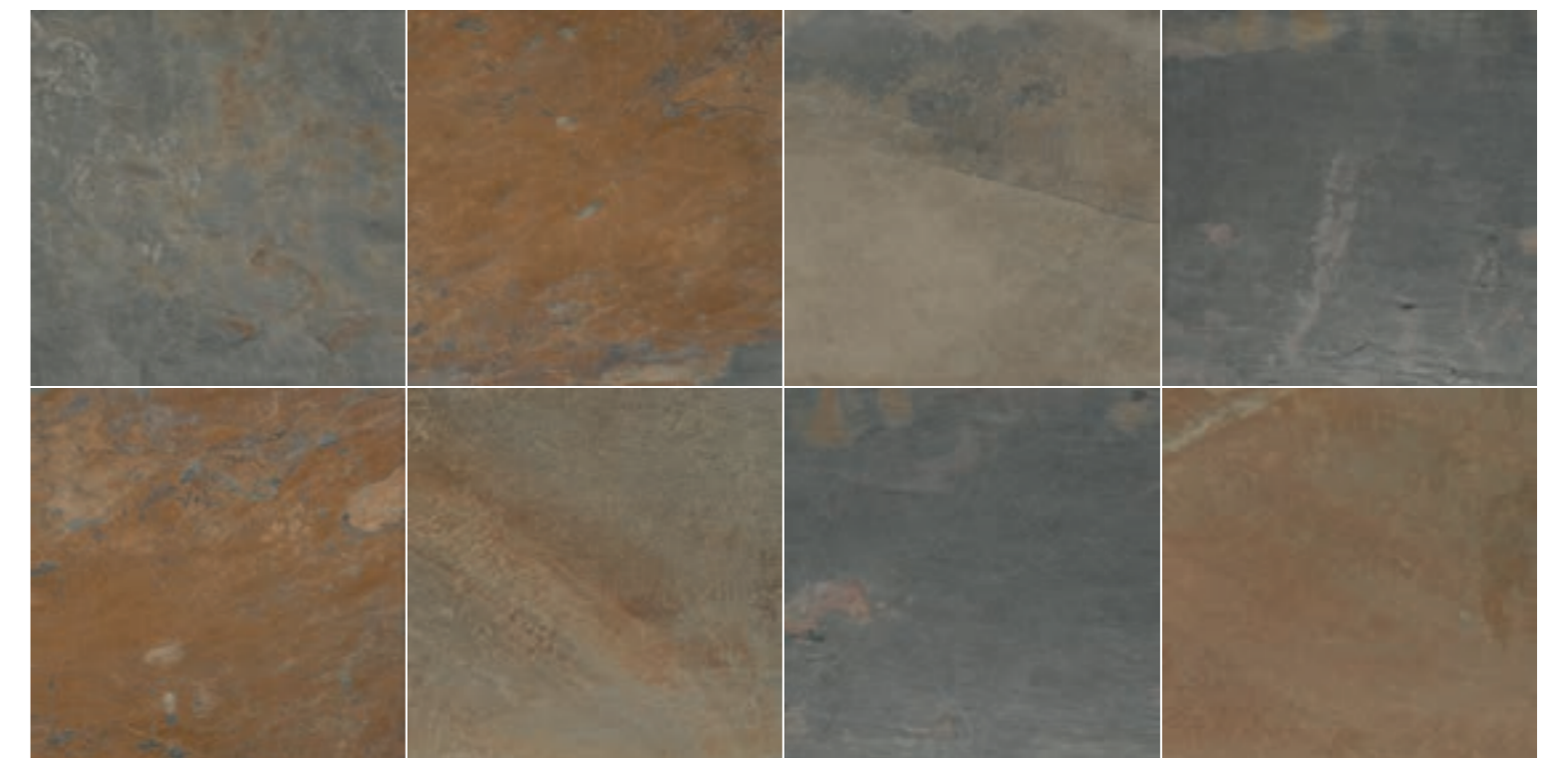

LÍNEA 2	LÍNEA 4	LÍNEA 8
29,5x59,2	29,5x59,2	29,5x59,2

Tendo em vista alcançar um efeito global mais real e harmonioso, são produzidas peças diferentes umas das outras com variações de desenho e/ou cores entre elas.
 For a more genuine and harmonious effect overall, different tiles with design and/or colour variations are produced.
 Afin d'obtenir un effet global plus réel et harmonieux, nos pièces sont différentes les unes des autres avec des variations de dessin et / ou de nuances entre elles.
 Para lograr un efecto global más real y armonioso, se producen piezas diferentes unas de otras con variaciones de diseño y/o color.



XISTO PRETO _ BRICK BLACK GLOSSY

STONES

XISTO

4 cores
colours
couleurs
colores

3 formatos
formats
formats
formatos

1 acabamento
finish
finition
acabado



Superfícies estruturadas que recriam a essência da pedra natural.

Structured surfaces that recreate the essence of natural stone.

Des surfaces structurées qui recréent l'essence de la pierre naturelle.

Superfícies estructuradas que recrean la esencia de la piedra natural.

59,2x118,6 cm
(23"x47")

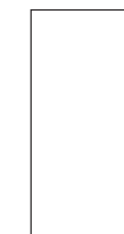

59,2x59,2 cm
(23"x23")

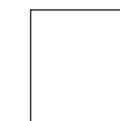

29,5x59,2 cm
(12"x23")



NAT · RECT

10

Até 10 desenhos
Up to 10 designs
Jusqu'à 10 dessins
Hasta 10 diseños

Superbranco

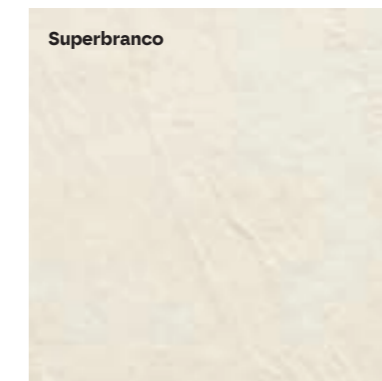

Marfim

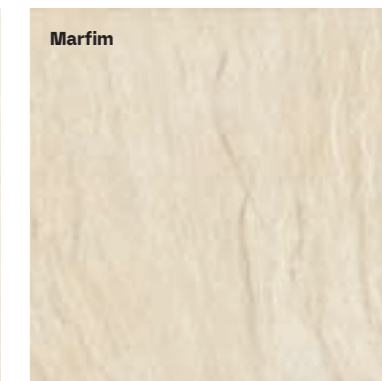

Multicolor

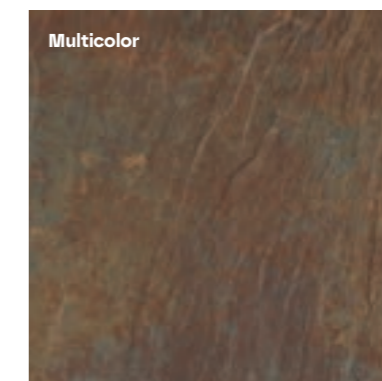

Preto

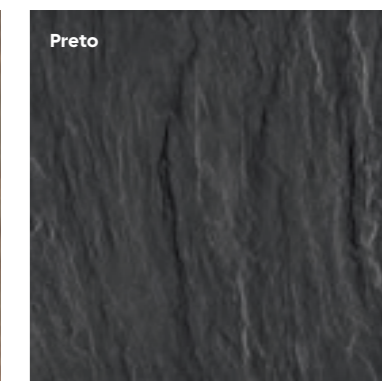



XISTO SUPERBRANCO

3120218841	30x60x0,85 cm	NAT	P85
3121218841	29,5x59,2x0,85 cm	RECT	P94
3121138841	59,2x59,2x0,85 cm	RECT	P107
3121D38841	59,2x118,6x0,98 cm	RECT	P127



XISTO MARFIM

3571215111	30x60x0,85 cm	NAT	P85
3471215111	29,5x59,2x0,85 cm	RECT	P94
3121135111	59,2x59,2x0,85 cm	RECT	P107
3471D35111	59,2x118,6x0,98 cm	RECT	P127

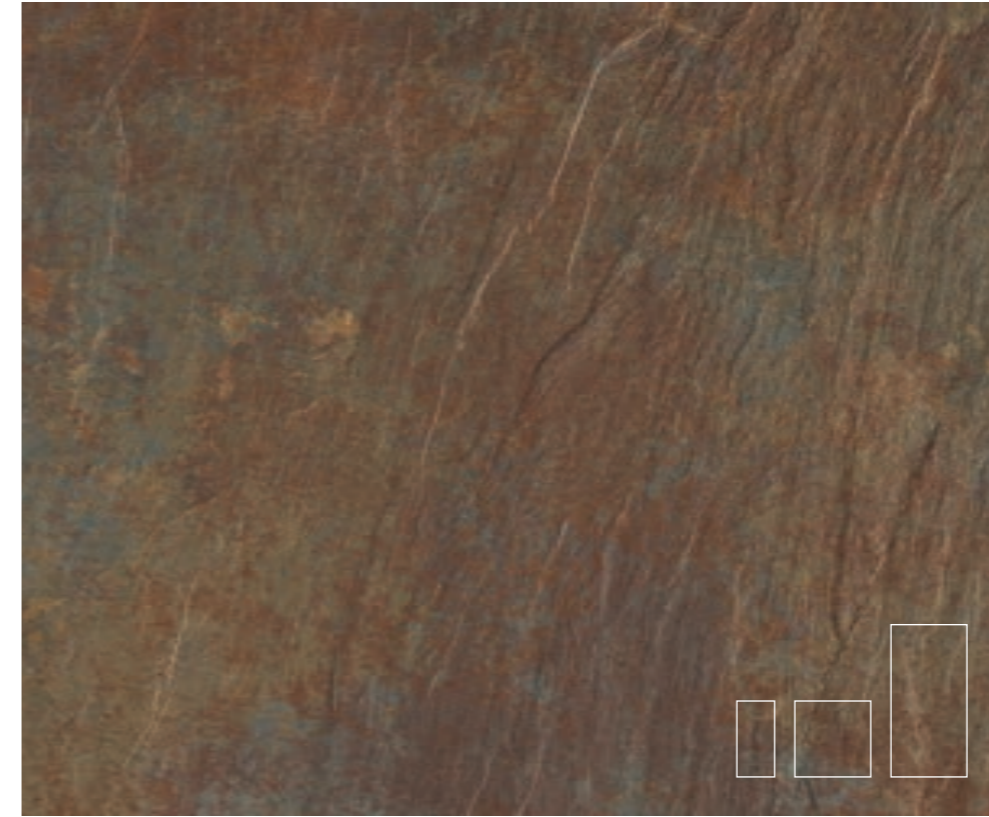

XISTO MULTICOLOR

3120218861	30x60x0,85 cm	NAT	P81
3121218861	29,5x59,2x0,85 cm	RECT	P91
3121138861	59,2x59,2x0,85 cm	RECT	P107
3121D38861	59,2x118,6x0,98 cm	RECT	P127

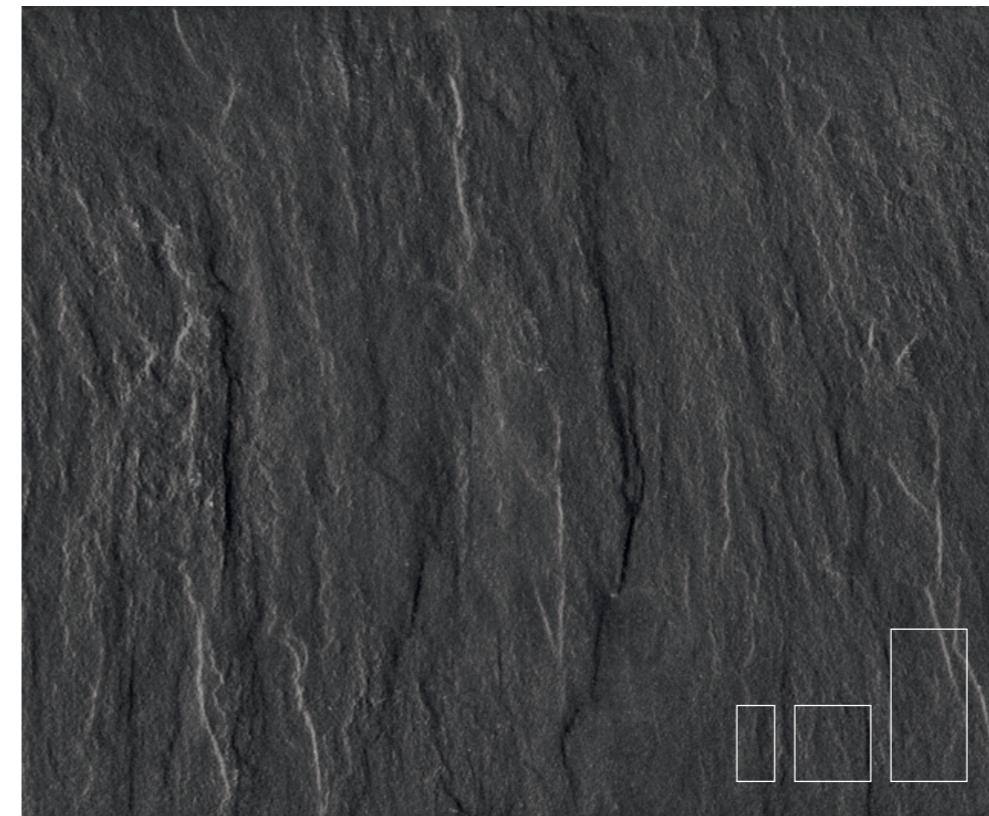

XISTO PRETO

3571215121	30x60x0,85 cm	NAT	P81
3471215121	29,5x59,2x0,85 cm	RECT	P91
3121135161	59,2x59,2x0,85 cm	RECT	P107
3471D35121	59,2x118,6x0,98 cm	RECT	P127



29,5x59,2 · 59,2x59,2 · 59,2x118,6 cm	V2	3	class 1	≥0,42
29,5x59,2 · 59,2x59,2 · 59,2x118,6 cm Multicolor	V4	3	class 1	-



STEP SILVER (a)

332112Z291 29,5x29,5x0,85 cm P96 /peça_pieza
[1m² = 11 peças_pieces]



DUO 36 XISTO MARFIM (a)

3321128961 29,5x29,5x0,85 cm P21 /peça_pieza
[1m² = 11 peças_pieces]



STEP GOLD (a)

332112Z281 29,5x29,5x0,85 cm P96 /peça_pieza
[1m² = 11 peças_pieces]



DUO 36 XISTO PRETO (a)

3321128971 29,5x29,5x0,85 cm P21 /peça_pieza
[1m² = 11 peças_pieces]

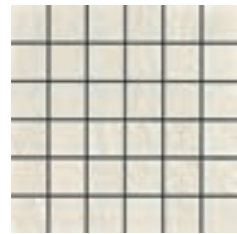

STRATUS 36 XISTO SUPERBRANCO (a)(f)

3321127361 29,5x29,5x0,85 cm P19 /peça_pieza
[1m² = 11 peças_pieces]



STRATUS 36 XISTO MARFIM (a)(f)

3471124861 29,5x29,5x0,85 cm P19 /peça_pieza
[1m² = 11 peças_pieces]



STRATUS 36 XISTO MULTICOLOR (a)(f)

3321127341 29,5x29,5x0,85 cm P19 /peça_pieza
[1m² = 11 peças_pieces]

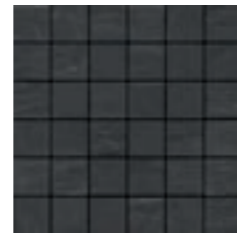

STRATUS 36 XISTO PRETO (a)(f)

3471124701 29,5x29,5x0,85 cm P19 /peça_pieza
[1m² = 11 peças_pieces]



STRATUS 9 XISTO SUPERBRANCO (a)(f)

3321127351 29,5x29,5x0,85 cm P19 /peça_pieza
[1m² = 11 peças_pieces]



STRATUS 9 XISTO MARFIM (a)(f)

3471124861 29,5x29,5x0,85 cm P19 /peça_pieza
[1m² = 11 peças_pieces]



STRATUS 9 XISTO MULTICOLOR (a)(f)

3321127331 29,5x29,5x0,85 cm P19 /peça_pieza
[1m² = 11 peças_pieces]



STRATUS 9 XISTO PRETO (a)(f)

3471124711 29,5x29,5x0,85 cm P19 /peça_pieza
[1m² = 11 peças_pieces]



DUO 8 XISTO MARFIM (a)

3321128981 29,5x29,5x0,85 cm P21 /peça_pieza
[1m² = 11 peças_pieces]



DUO 8 XISTO PRETO (a)

3321128991 29,5x29,5x0,85 cm P21 /peça_pieza
[1m² = 11 peças_pieces]





PEÇAS · PIECES			CAIXA · BOX			EUROPALETE · EUROPALLET		
		±	PZ	M ²	KG	CX	M ²	KG
30x60 cm	NAT	8,5 ±5%	8	1,44	28.80	32	46.08	943
29,5x59,2 cm	RECT	8,5 ±5%	8	1,40	28.80	32	44.80	943
59,2x59,2 cm	RECT	8,5 ±5%	4	1,40	28.70	36	50.40	1053
59,2x118,6 cm	RECT	9,8 ±5%	2	1,40	33.00	30	42.00	1011

PEÇA · PIECE			PEÇA · PIECE			PEÇA · PIECE			PEÇA · PIECE			PEÇA · PIECE		
DG	NAT	RECT	RB	NAT	RECT	DG CF	RECT	DG CF SS	RECT	DG CF CANTO	RECT	DG CF CANTO	RECT	
29,5x29,5 cm	P08	P10	9,5x29,5 cm	P07	P08	29,5x59,2 cm	P157	29,5x59,2 cm	P157	29,5x59,2 cm	P207	29,5x59,2 cm	P207	
29,5x59,2 cm	P12	P18	8x59,2 cm	P10	P12									
59,2x59,2 cm	-	P36	8x118,6 cm	-	P28									
29,5x118,6 cm	-	P96												
59,2x118,6 cm	-	P167												

DG CF / DG CF Canto/DG CF SS: Peças produzidas sob encomenda. Altura do focinho: entre 3 cm e 10 cm. Indicar a altura pretendida no ato da encomenda.
 DG CF / DG CF Canto/DG CF SS: Pieces produced on order. Trim height: 3 to 10 cm. Specify desired height when placing a order.
 DG CF / DG CF Canto/DG CF SS: Pièces produites sur commande. Hauteur du nez de marche : entre 3 cm et 10 cm. Préciser la hauteur souhaitée lors de la commande.
 DG CF / DG CF Canto/DG CF SS: Piezas producidas por encargo. Altura del ángulo: entre 3 y 10 cm. Indicar la altura deseada al realizar el pedido.

DG CF Canto: Disponível em canto esquerdo e direito.
 DG CF Canto: Available in left and right corner.
 DG CF Canto: Disponible en angle gauche et droit.
 DG CF Canto: Canto izquierdo y derecho disponibles.

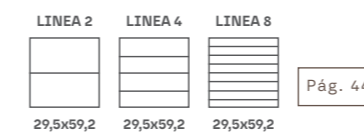
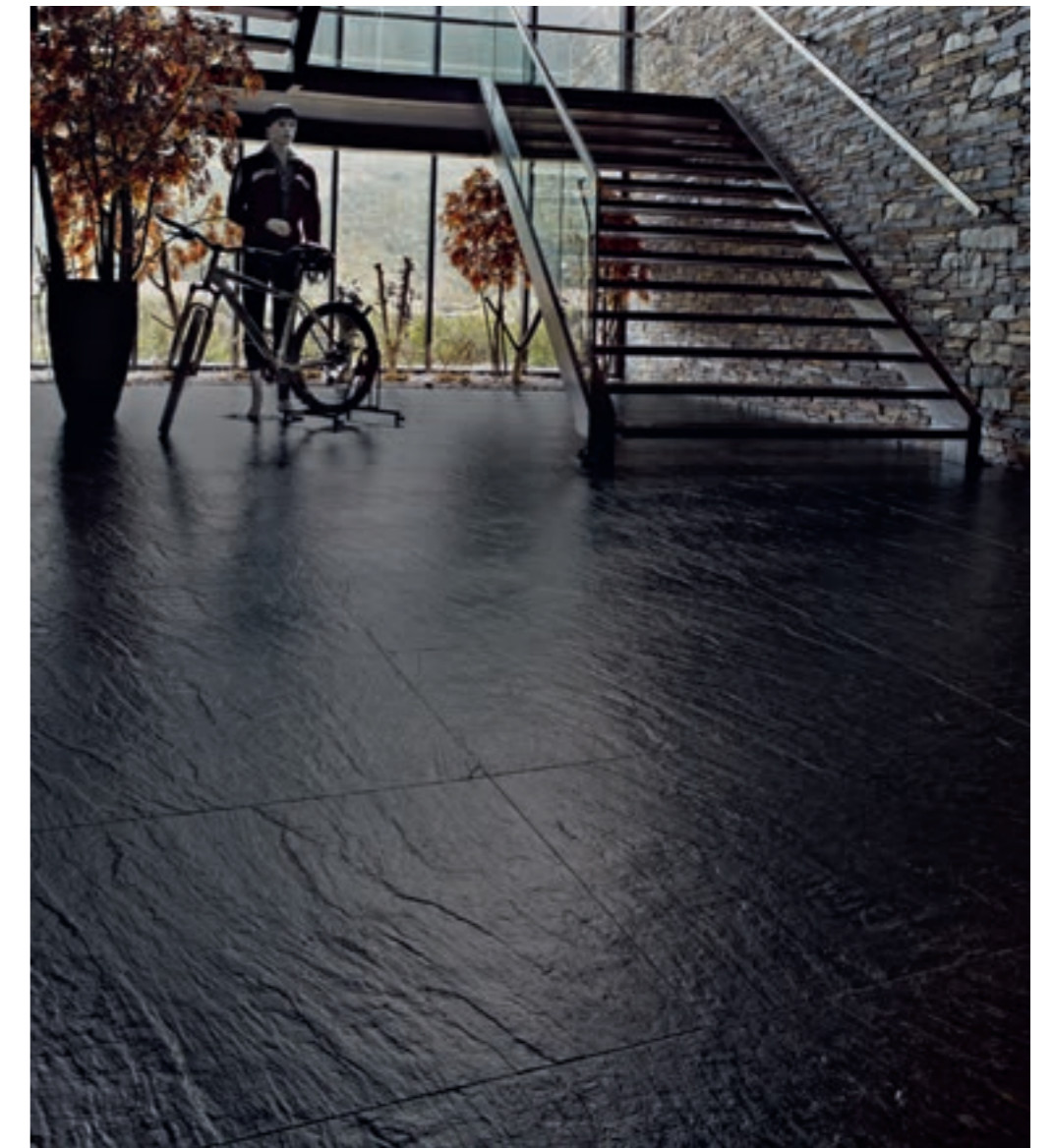



ARIZONA FOG _ ARIZONA ANTRACITE

STONES

ARIZONA

6 cores
colours
couleurs
colores

1 formato
format
format
formato

1 acabamento
finish
finition
acabado



Pavimentos cerâmicos terracota para exteriores que apelam à vida ao ar livre.

Terracota exterior ceramic floortiles that call to outdoor living.

Un Carrelage effet Terre Cuite aux teintes couleur terre pour l'extérieur qui appellent à la vie en plein air.

Pavimentos cerâmicos con colores tierra para exteriores que evocan la vida al aire libre.

45x45 cm
(18"x18")

NAT

8

Até 8 desenhos
Up to 8 designs
Jusqu'à 8 dessins
Hasta 8 diseños

Bege



Brick

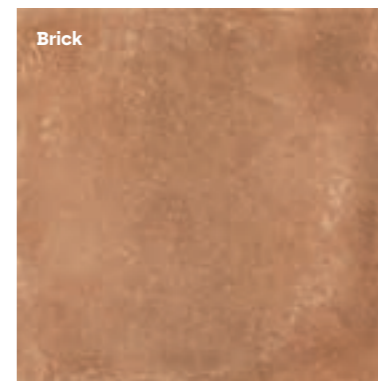

Fog

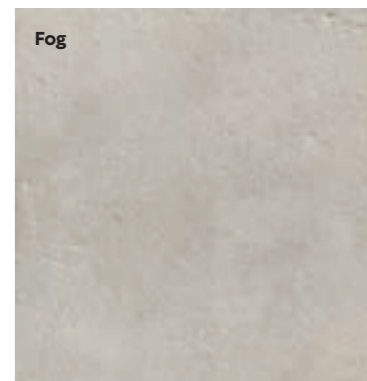

Coral

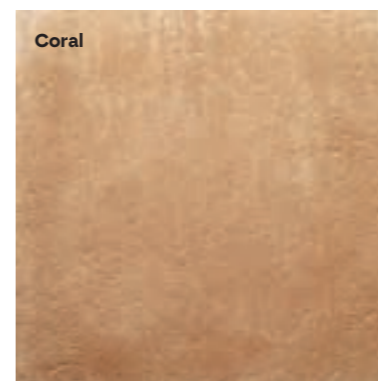

Terracotta

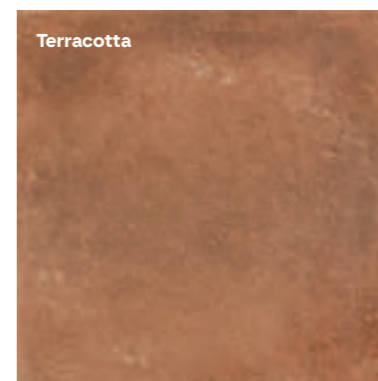

Antracite



ARIZONA



ARIZONA BEGE ****

311007T951 45x45x0,82 cm NAT P67



ARIZONA BRICK ****

311007T891 45x45x0,82 cm NAT P67



ARIZONA CORAL ****

311007T921 45x45x0,82 cm NAT P67



ARIZONA TERRACOTTA ****

311007T901 45x45x0,82 cm NAT P67



ARIZONA FOG ****

311007T931 45x45x0,82 cm NAT P67



ARIZONA ANTRACITE ***

311007T911 45x45x0,82 cm NAT P67

ARIZONA



PEÇAS · PIECES			CAIXA · BOX			EUROPALETE · EUROPALLET		
±			PZ	M²	KG	CX	M²	KG
45x45 cm	NAT	8,2 ±5%	6	1,22	24,00	34	41,48	837

PEÇA · PIECE		PEÇA · PIECE	
DG	NAT	RB	NAT
45x45 cm	P10	8x45 cm	P07



STONES

STONES

Tendo em vista alcançar um efeito global mais real e harmonioso, são produzidas peças diferentes umas das outras com variações de desenho e/ou cores entre elas.
 For a more genuine and harmonious effect overall, different tiles with design and/or colour variations are produced.
 Afin d'obtenir un effet global plus réel et harmonieux, nos pièces sont différentes les unes des autres avec des variations de dessin et / ou de nuances entre elles.
 Para lograr un efecto global más real y armonioso, se producen piezas diferentes unas de otras con variaciones de diseño y/o color.

45x45 cm	V3	3	class 3
----------	----	---	---------



EDICER PEDRALVA BEGE

STONES

EDICER PEDRALVA



4 cores
colours
couleurs
colores

1 formato
format
format
formato

1 acabamento
finish
finition
acabado

Pavimento cerâmico para exterior com o efeito da calçada portuguesa, que enriquece varandas e pátios.

Floor tiles resembling the traditional Portuguese cobblestone pavement for enhancing balconies, patios and gardens.

Cerrelage avec l'effet du "troMoir" portugais qui enrichissent terrasses et patios.

Pavimento cerâmicos con el efecto de la calzada portuguesa, que enriquecen balcones y patios.

45x45 cm
(18"x18")



NAT

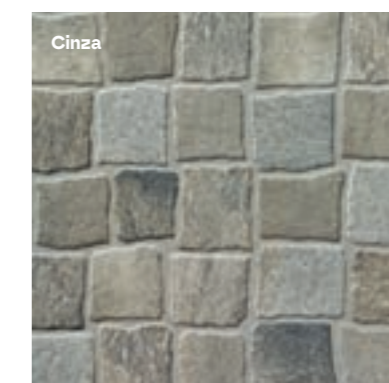

EDICER PEDRALVA



EDICER PEDRALVA DUNA ****

31100783T5 45x45x0,82 cm NAT P59



EDICER PEDRALVA BEGE ****

3110077655 45x45x0,82 cm NAT P59



EDICER PEDRALVA CINZA ****

3110077645 45x45x0,82 cm NAT P59



EDICER PEDRALVA ÂMBAR ****

3110077635 45x45x0,82 cm NAT P59

EDICER PEDRALVA



CLASS 3

PEÇAS · PIECES			CAIXA · BOX			EUROPALETE · EUROPALLET		
			PZ	M²	KG	CX	M²	KG
45x45 cm	NAT	8,2 ±5%	6	1,22	24,00	34	41,48	837

PEÇA · PIECE		PEÇA · PIECE	
DG	NAT	RB	NAT
45x45 cm	P08	8x45 cm	P05



STONES

STONES



45x45 cm V3 3 class 3



MARBLES

NEW FORMAT	LIGHT XL	Calacatta Classic	276
NEW FORMAT	LIGHT XL	Statuario White	286
		Rainforest Green	292
		Onix Gold	300
		Emperador Brown	306
		Baltic Grey	310
		Absolut Black	314
		Calacatta Oro	318
		Calacatta Bianco	326



MARBLES

CALACATTA CLASSIC



- 1 cor
colour
couleur
color
- 8 formatos
formats
formats
formats
- 2 acabamentos
finishes
finitions
acabados

Veios ousados sobre fundo branco, revelam a pureza matéria deste mármore italiano.

Bold veins on a white background, reveal the purity of material of this Italian marble.

Des veines audacieuses sur fond blanc, révèlent la pureté de la matière de ce marbre italien.

Osadas vetas sobre fondo blanco revelan la pureza matérica de este mármol italiano.



MATT RECT · POL

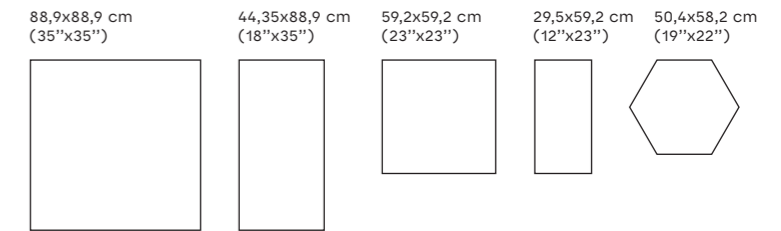
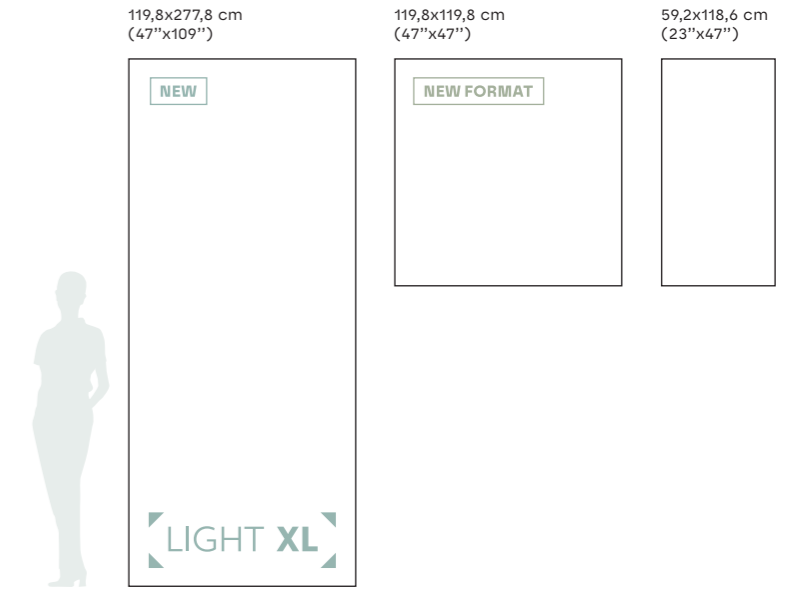

14

Até 14 desenhos
Up to 14 designs
Jusqu'à 14 dessins
Hasta 14 diseños

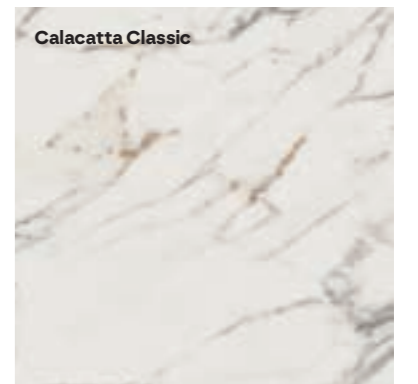

CALACATTA CLASSIC



Para o assentamento de peças de grande formato, sugerimos a utilização de niveladores para ajudar a posicionar e nivelar peças.
When laying large format tiles, use levelling spacers to ensure proper installing and levelling of tiles.
Pour la pose de pièces de grand format, nous suggérons l'utilisation de croisillons autonivelants pour aider à positionner et à niveler les pièces.
Para la colocación de piezas de gran tamaño, sugerimos utilizar niveladores para ayudar a colocar y nivelar piezas.

CALACATTA CLASSIC

LIGHT XL



CALACATTA CLASSIC

301BX43V71	119,8x277,8x0,60 cm	MATT RECT	P149
3012X43V71	119,8x277,8x0,60 cm	POL	P173

Até 4 desenhos
Up to 4 designs
Jusqu'à 4 dessins
Hasta 4 diseños

GRAPHIC VARIATION



LIGHT XL é ideal para renovações, sem demolições. Este grande formato de espessura fina garante a qualidade técnica do grés porcelânico aliada ao efeito estético apresentado.
LIGHT XL is perfect for renovation without demolition. This large, thin format guarantees the technical quality of porcelain tiles combined with the aesthetic effect described above.
LIGHT XL est idéal pour les rénovations, sans démolition. Ce grand format de faible épaisseur garantit la qualité technique du grés cérame combinée à l'effet esthétique présenté.
LIGHT XL es ideal para renovaciones, sin demoliciones. Este gran formato, con espesor fino, garantiza la calidad técnica del gres porcelánico aliado al efecto estético que presenta.

Fornecido em caixa de madeira: preço sob consulta.
Delivered in a wooden box: price on request.
Fourniture dans un boitage bois : prix sur demande.
Se entrega en una caja de madera: precio bajo presupuesto.

CALACATTA
CLASSIC



MARBLES

280

revigres

CALACATTA CLASSIC _ RAINFOREST GREEN _ ABSOLUT BLACK

MARBLES

281

revigres

CALACATTA CLASSIC

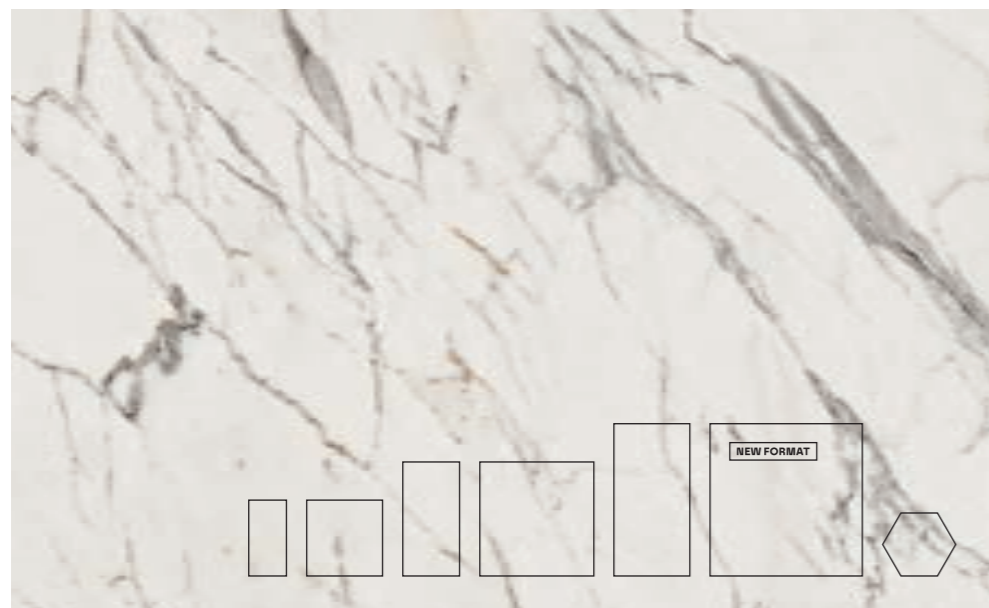

CALACATTA CLASSIC

311B213V71	29,5x59,2x0,98 cm	MATT RECT	P91
3112213V71	29,5x59,2x0,98 cm	POL	P105
311B133V71	59,2x59,2x0,98 cm	MATT RECT	P91
3112133V71	59,2x59,2x0,98 cm	POL	P105
311BH83V71	44,35x88,9x1,05 cm	MATT RECT	P99
3112H83V71	44,35x88,9x1,05 cm	POL	P112
311BK73V71	88,9x88,9x1,05 cm	MATT RECT	P104
3112K73V71	88,9x88,9x1,05 cm	POL	P116
311BD33V71	59,2x118,6x0,98 cm	MATT RECT	P104
3112D33V71	59,2x118,6x0,98 cm	POL	P116
NEW 301BX33V71	119,8x119,8x0,90 cm	MATT RECT	P127
NEW 3012X33V71	119,8x119,8x0,90 cm	POL	P140

HEXAGONO CALACATTA CLASSIC (*)

331BV08V51	50,4x58,2x0,98 cm	MATT RECT	P209
3312V08V51	50,4x58,2x0,98 cm	POL	P245



FILATI CALACATTA CLASSIC (***)

331B6A0W11	14x59x0,98 cm	MATT RECT	P14 /peça_pieza
33126A0W11	14x59x0,98 cm	POL	P14 /peça_pieza



HEXAGONO CALACATTA CLASSIC

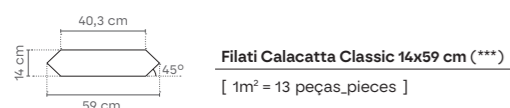
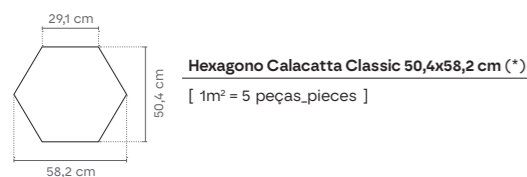

29,5x59,2 · 59,2x118,6 · 88,9x88,9 cm	MATT RECT	V3	3	class 1	≥0,42	U4P3E3C2
29,5x59,2 · 59,2x59,2 · 59,2x118,6 · 88,9x88,9 cm	POL	V3	2	-	-	U3P3E3C2
44,35x88,9 cm	MATT RECT	V3	3	class 1	≥0,42	-
44,35x88,9 cm	POL	V3	2	-	-	-
59,2x59,2 cm	MATT RECT	V3	3	class 1	≥0,42	U4P4+E3C2
119,8x119,8 cm	MATT RECT	V4	3	class 1	≥0,42	-
119,8x119,8 cm	POL	V4	2	-	-	-

CALACATTA CLASSIC



CALACATTA CLASSIC _ ROYAL GOLD _ CITYZEN GRIS _ CITYZEN CARBON

(*) Peças produzidas de acordo com quantidades mínimas de 10m².
 (*) Pieces produced in minimum quantities of 10m².
 (*) Pièces produites selon des quantités minimales de 10m².
 (*) Piezas producidas en cantidades mínimas de 10m².
 (***) Peças produzidas de acordo com quantidades mínimas de 10 peças.
 (***) Pieces produced in minimum quantities of 10 pieces.
 (***) Pièces produites selon des quantités minimales de 10 pièces.
 (***) Piezas producidas en cantidades mínimas de 10 piezas.

CALACATTA CLASSIC

CALACATTA CLASSIC



ROYAL GOLD (e)

3312D3W891 59,2x118,6x0,98 cm POL P331/peça_pieza



ROYAL GOLD



	PEÇAS · PIECES		CAIXA · BOX			EUROPALETTE · EUROPALLET		
		±	PZ	M ²	KG	CX	M ²	KG
29,5x59,2 cm	MATT RECT	9,8 ±5%	8	1.40	33.20	32	44.80	1 083
	POL	9,8 ±5%	8	1.40	33.20	32	44.80	1 083
59,2x59,2 cm	MATT RECT	9,8 ±5%	4	1.40	33.00	32	44.80	1 077
	POL	9,8 ±5%	4	1.40	33.00	32	44.80	1 077
50,4x58,2 cm	MATT RECT	9,8 ±5%	4	0.88	20.20	32	28.16	667
	POL	9,8 ±5%	4	0.88	20.20	32	28.16	667
44,35x88,9 cm	MATT RECT	10,5 ±0,5mm	4	1.58	38.00	24	37.92	967
	POL	10,5 ±0,5mm	4	1.58	38.00	24	37.92	967
88,9x88,9 cm	MATT RECT	10,5 ±0,5mm	2	1.58	38.00	24	37.92	967
	POL	10,5 ±0,5mm	2	1.58	38.00	24	37.92	967
59,2x118,6 cm	MATT RECT	9,8 ±5%	2	1.40	33.00	30	42.00	1 011
	POL	9,8 ±5%	2	1.40	33.00	27	37.80	912
119,8x119,8 cm	MATT RECT	9,0 ±5%	1	1.44	28.10	32	46.08	959.20
	POL	9,0 ±5%	1	1.44	28.10	32	46.08	959.20
119,8x277,8 cm	MATT RECT	6,0 ±5%	1	3.33	50.40	18	59.94	1 019
	POL	6,0 ±5%	1	3.33	50.40	18	59.94	1 019

 PEÇA · PIECE			 PEÇA · PIECE			 PEÇA · PIECE			 PEÇA · PIECE			 PEÇA · PIECE		
DG	MATT RECT	POL	RB	MATT RECT	POL	DG CF	MATT RECT	POL	DG CF SS	MATT RECT	POL	DG CF CANTO	MATT RECT	POL
29,5x59,2 cm	P18	P18	9,5x29,5 cm	P08	P08	29,5x59,2 cm	P157	P157	29,5x59,2 cm	P157	P157	29,5x59,2 cm	P207	P207
59,2x59,2 cm	P36	P36	8x44,35 cm	P16	P18									
44,35x88,9 cm	P97	P97	8x59,2 cm	P12	P12									
29,5x118,6 cm	P97	P97	8x88,9 cm	P28	P28									
59,2x118,6 cm	P167	P167	8x118,6 cm	P28	P28									

DG CF Canto: Disponível em canto esquerdo e direito.
 DG CF Canto: Available in left and right corner.
 DG CF Canto: Disponible en angle gauche et droit.
 DG CF Canto: Canto izquierdo y derecho disponibles.

DG CF / DG CF Canto/DG CF SS: Peças produzidas sob encomenda. Altura do fochino: entre 3 cm e 10 cm. Indicar a altura pretendida no ato da encomenda.
 DG CF / DG CF Canto/DG CF SS: Pièces produites sur commande. Hauteur du nez de marche : entre 3 cm et 10 cm. Préciser la hauteur souhaitée lors de la commande.
 DG CF / DG CF Canto/DG CF SS: Piezas producidas por encargo. Altura del ángulo: entre 3 y 10 cm. Indicar la altura deseada al realizar el pedido.

GRAPHIC VARIATION

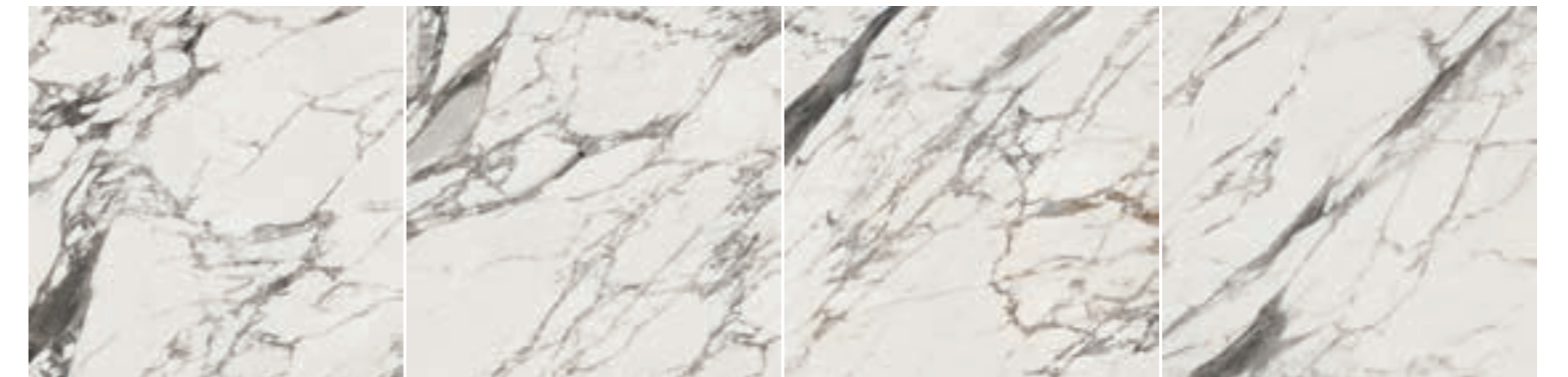

De modo a proteger a superfície das peças, os produtos no acabamento polido têm uma fina camada de impermeabilizante, que apenas deve ser removida após a conclusão da obra.
 Tiles with polished finish are protected with waterproof coating that must be removed only after the works are concluded.
 En vue de protéger la surface des pièces, les produits à la finition polie ont une fine couche d'imperméabilisant qui ne devrait être enlevée qu'après l'achèvement des travaux.
 Con el fin de proteger la superficie de las piezas, los productos con acabado pulido tienen una fina capa de impermeabilizante, que solo debe eliminarse una vez terminado el trabajo.
 Tendo em vista alcançar um efeito global mais real e harmonioso, são produzidas peças diferentes umas das outras com variações de desenho e/ou cores entre elas.
 For a more genuine and harmonious effect overall, different tiles with design and/or colour variations are produced.
 Afin d'obtenir un effet global plus réel et harmonieux, nos pièces sont différentes les unes des autres avec des variations de dessin et / ou de nuances entre elles.
 Para lograr un efecto global más real y armonioso, se producen piezas diferentes unas de otras con variaciones de diseño y/o color.

STATUARIO WHITE



1 cor colour couleur color 7 formatos formats formats formatos 2 acabamentos finishes finitions acabados

A pureza da matéria refletida na cerâmica para ambientes exclusivos.

The purity of the material reflected in ceramics for exclusive environments.

La pureté de la matière reflétée dans la céramique pour des ambiances exclusives.

La pureza de la materia reflejada en la cerámica para ambientes exclusivos.



MATT RECT · POL

119,8x277,8 cm
(47"x109")

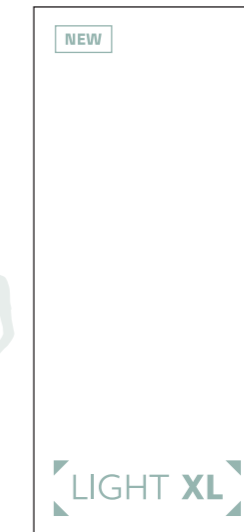

119,8x119,8 cm
(47"x47")



59,2x118,6 cm
(23"x47")

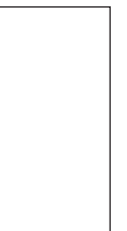

88,9x88,9 cm
(35"x35")

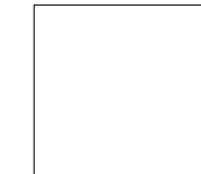

44,35x88,9 cm
(18"x35")



59,2x59,2 cm
(23"x23")



29,5x59,2 cm
(12"x23")

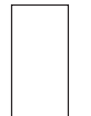

13

Até 13 desenhos
Up to 13 designs
Jusqu'à 13 dessins
Hasta 13 diseños

Statuario White



STATUARIO WHITE



STATUARIO WHITE _ BRICK WHITE GLOSSY

Para o assentamento de peças de grande formato, sugerimos a utilização de niveladores para ajudar a posicionar e nivelar peças.
When laying large format tiles, use levelling spacers to ensure proper installing and levelling of tiles.
Pour la pose de pièces de grand format, nous suggérons l'utilisation de croisillons autonivelants pour aider à positionner et à niveler les pièces.
Para la colocación de piezas de gran tamaño, sugerimos utilizar niveladores para ayudar a colocar y nivelar piezas.

STATUARIO WHITE

LIGHT XL

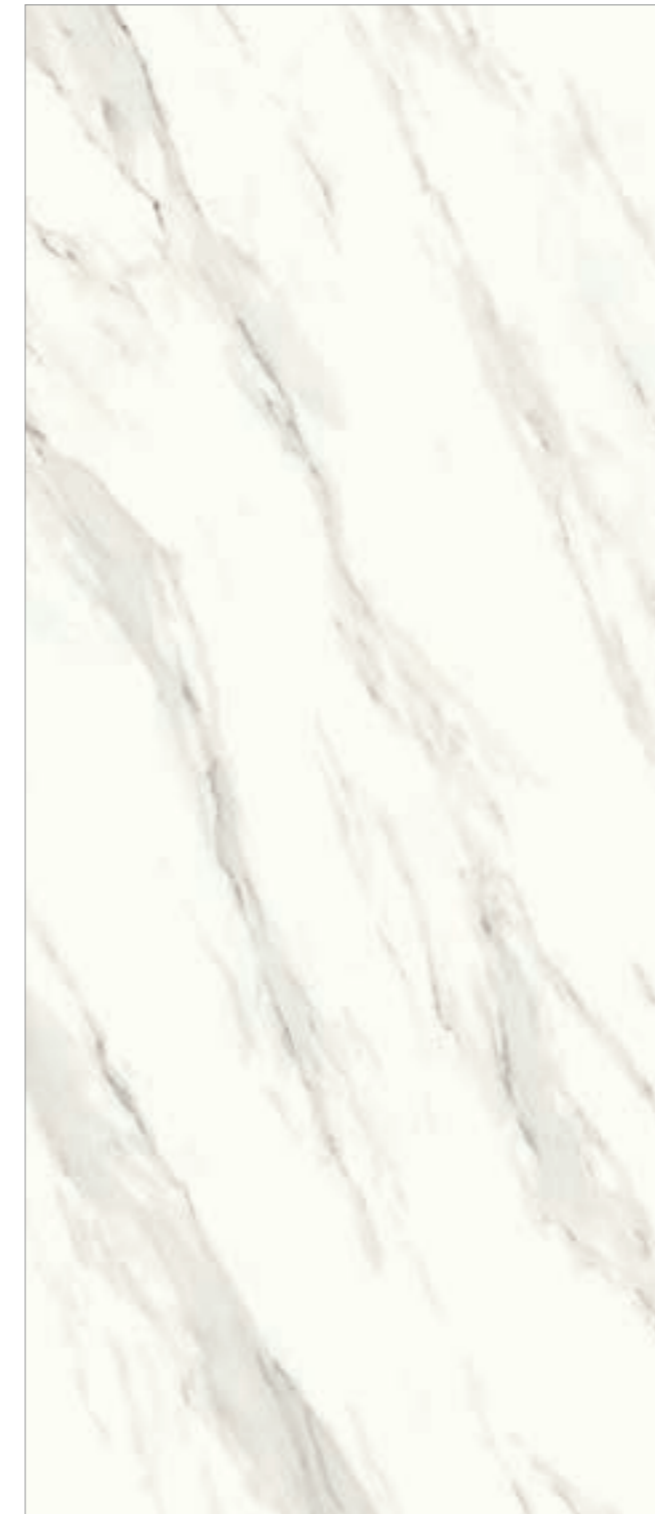

STATUARIO WHITE

301BX4U901	119,8x277,8x0,60 cm	MATT RECT	P149
3012X4U901	119,8x277,8x0,60 cm	POL	P173

Até 3 desenhos
Up to 3 designs
Jusqu'à 3 dessins
Hasta 3 diseños

GRAPHIC VARIATION

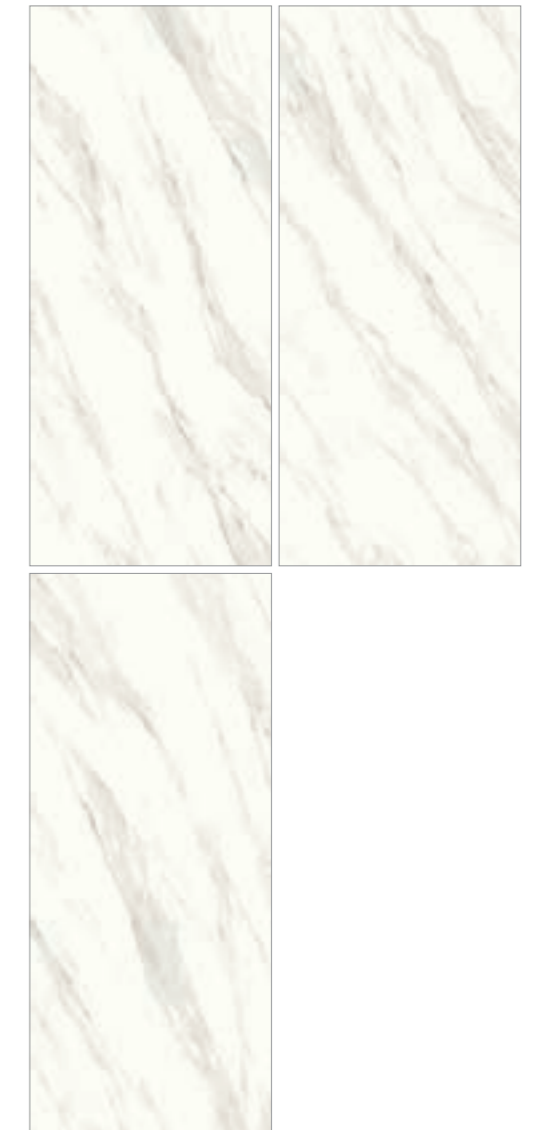

LIGHT XL é ideal para renovações, sem demolições. Este grande formato de espessura fina garante a qualidade técnica do grés porcelânico aliada ao efeito estético apresentado.
LIGHT XL is perfect for renovation without demolition. This large, thin format guarantees the technical quality of porcelain tiles combined with the aesthetic effect described above.
LIGHT XL est idéal pour les rénovations, sans démolition. Ce grand format de faible épaisseur garantit la qualité technique du grés cérame combinée à l'effet esthétique présenté.
LIGHT XL es ideal para renovaciones, sin demoliciones. Este gran formato, con espesor fino, garantiza la calidad técnica del gres porcelánico aliado al efecto estético que presenta.

Fornecido em caixa de madeira: preço sob consulta.
Delivered in a wooden box: price on request.
Fourniture dans un boitage bois : prix sur demande.
Se entrega en una caja de madera: precio bajo presupuesto.

STATUARIO WHITE



STATUARIO WHITE

311121U901	29,5x59,2x0,98 cm	MATT RECT	P91
311221U901	29,5x59,2x0,98 cm	POL	P105
311B13U901	59,2x59,2x0,98 cm	MATT RECT	P91
311213U901	59,2x59,2x0,98 cm	POL	P105
311BH8U901	44,35x88,9x1,05 cm	MATT RECT	P99
3112H822X1	44,35x88,9x1,05 cm	POL	P112
311BK7U901	88,9x88,9x1,05 cm	MATT RECT	P104
3112K7U901	88,9x88,9x1,05 cm	POL	P116
311BD3U901	59,2x118,6x0,98 cm	MATT RECT	P104
3112D3U901	59,2x118,6x0,98 cm	POL	P116
NEW 301BX3U901	119,8x119,8x0,90 cm	MATT RECT	P127
NEW 3012X3U901	119,8x119,8x0,90 cm	POL	P140

STATUARIO WHITE



	PEÇAS · PIECES		CAIXA · BOX			EUROPALETE · EUROPALLET		
		±	PZ	M²	KG	CX	M²	KG
29,5x59,2 cm	MATT RECT	9,8 ±5%	8	1.40	33.20	32	44.80	1 083
	POL	9,8 ±5%	8	1.40	33.20	32	44.80	1 083
59,2x59,2 cm	MATT RECT	9,8 ±5%	4	1.40	33.00	32	44.80	1 077
	POL	9,8 ±5%	4	1.40	33.00	32	44.80	1 077
44,35x88,9 cm	MATT RECT	10,5 ±0,5mm	4	1.58	38.00	24	37.92	967
	POL	10,5 ±0,5mm	4	1.58	38.00	24	37.92	967
88,9x88,9 cm	MATT RECT	10,5 ±0,5mm	2	1.58	38.00	24	37.92	967
	POL	10,5 ±0,5mm	2	1.58	38.00	24	37.92	967
59,2x118,6 cm	MATT RECT	9,8 ±5%	2	1.40	33.00	30	42.00	1 011
	POL	9,8 ±5%	2	1.40	33.00	27	37.80	912
119,8x119,8 cm	MATT RECT	9,0 ±5%	1	1.44	28.10	32	46.08	959.20
	POL	9,0 ±5%	1	1.44	28.10	32	46.08	959.20
119,8x277,8 cm	MATT RECT	6,0 ±5%	1	3.33	50.40	18	59.94	1 019
	POL	6,0 ±5%	1	3.33	50.40	18	59.94	1 019



MODULOR STATUARIO (a)(b)(d)(f)

3311S28Y81	33x37x0,98 cm	P32 /peça_pieza
------------	---------------	-----------------

[1m² = 11 peças_pieces]



PEAK ABSOLUT (a)(b)(d)

Base: Absolut Black + Statuario White

3311129Y01	29,5x29,5x0,98 cm	P32 /peça_pieza
------------	-------------------	-----------------

[1m² = 14 peças_pieces]



HEXA STATUARIO (a)(b)(d)

Base: Absolut Black + Statuario White

3311S18Y91	24x29,5x0,98 cm	P32 /peça_pieza
------------	-----------------	-----------------

[1m² = 22 peças_pieces]

PEÇA · PIECE			PEÇA · PIECE			PEÇA · PIECE			PEÇA · PIECE			PEÇA · PIECE		
DG	MATT RECT	POL	RB	MATT RECT	POL	DG CF	MATT RECT	POL	DG CF SS	MATT RECT	POL	DG CF CANTO	MATT RECT	POL
29,5x59,2 cm	P18	P18	9,5x29,5 cm	P08	P08	29,5x59,2 cm	P157	P157	29,5x59,2 cm	P157	P157	29,5x59,2 cm	P207	P207
59,2x59,2 cm	P36	P36	8x44,35 cm	P16	P16									
44,35x88,9 cm	P96	P96	8x59,2 cm	P12	P12									
29,5x118,6 cm	P96	P96	8x88,9 cm	P28	P28									
59,2x118,6 cm	P167	P167	8x118,6 cm	P28	P28									

DG CF Canto: Disponível em canto esquerdo e direito.
 DG CF Canto: Available in left and right corner.
 DG CF Canto: Disponible en angle gauche et droit.
 DG CF Canto: Canto izquierdo y derecho disponibles.

DG CF / DG CF Canto/DG CF SS: Peças produzidas sob encomenda. Altura do flocinho: entre 3 cm e 10 cm. Indicar a altura pretendida no ato da encomenda.
 DG CF / DG CF Canto/DG CF SS: Pieces produced on order. Trim height: 3 to 10 cm. Specify desired height when placing a order.
 DG CF / DG CF Canto/DG CF SS: Pièces produites sur commande. Hauteur du nez de marche : entre 3 cm et 10 cm. Préciser la hauteur souhaitée lors de la commande.
 DG CF / DG CF Canto/DG CF SS: Piezas producidas por encargo. Altura del ángulo: entre 3 y 10 cm. Indicar la altura deseada al realizar el pedido.

GRAPHIC VARIATION

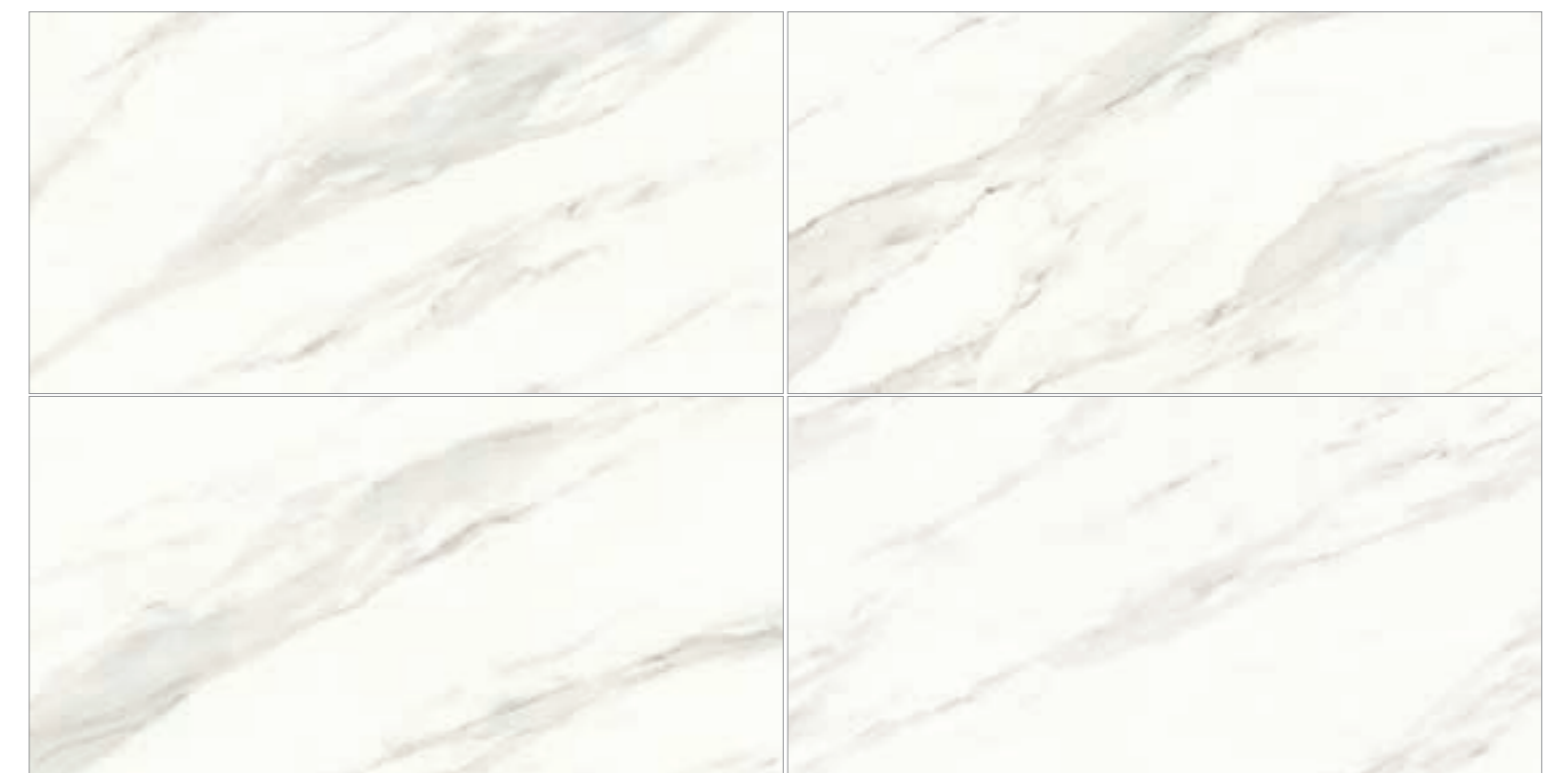

De modo a proteger a superfície das peças, os produtos no acabamento polido têm uma fina camada de impermeabilizante, que apenas deve ser removida após a conclusão da obra.

Tiles with polished finish are protected with waterproof coating that must be removed only after the works are concluded.

En vue de protéger la surface des pièces, les produits à la finition polie ont une fine couche d'imperméabilisant qui ne devrait être enlevée qu'après l'achèvement des travaux.

Con el fin de proteger la superficie de las piezas, los productos con acabado pulido tienen una fina capa de impermeabilizante, que solo debe eliminarse una vez terminado el trabajo.

Tendo em vista alcançar um efeito global mais real e harmonioso, são produzidas peças diferentes umas das outras com variações de desenho e/ou cores entre elas.

For a more genuine and harmonious effect overall, different tiles with design and/or colour variations are produced.

Afin d'obtenir un effet global plus réel et harmonieux, nos pièces sont différentes les unes des autres avec des variations de dessin et / ou de nuances entre elles.

Para lograr un efecto global más real y armonioso, se producen piezas diferentes unas de otras con variaciones de diseño y/o color.



29,5x59,2 · 59,2x118,6 · 88,9x88,9 cm	MATT RECT	V3	3	class 1	≥0,42	U4P3E3C2
29,5x59,2 · 59,2x59,2 · 59,2x118,6 · 88,9x88,9 cm	POL	V3	2	-	-	U3P3E3C2
44,35x88,9 cm	MATT RECT	V3	3	class 1	≥0,42	-
44,35x88,9 cm	POL	V3	2	-	-	-
59,2x59,2 cm	MATT RECT	V3	3	class 1	≥0,42	U4P4+E3C2
119,8x119,8 cm	MATT RECT	V4	3	class 1	≥0,42	-
119,8x119,8 cm	POL	V4	2	-	-	-



MARBLES

RAINFOREST GREEN



1 cor colour couleur color 6 formatos formats formats 2 acabamentos finishes finitions acabados

Originário da Índia, com um fundo verde e veios exóticos, inspira a magia de uma floresta tropical.

Originating in India, it brandishes exotic veins against a green backdrop that bring to mind the magic of a rainforest.

Originaire d'Inde, avec un fond vert et des veines exotiques, inspire la magie d'une forêt tropicale.

Originario de la India, con un fondo verde y exóticas vetas, sugiere la magia de una selva tropical.

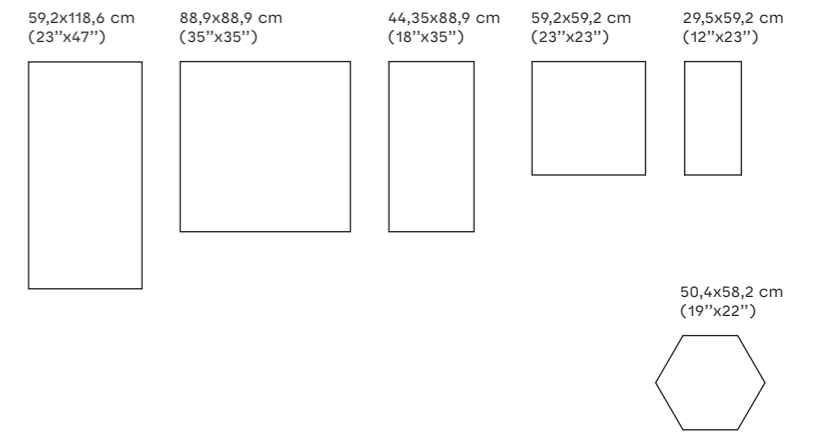

MATT RECT · POL

14
Até 14 desenhos
Up to 14 designs
Jusqu'à 14 dessins
Hasta 14 diseños

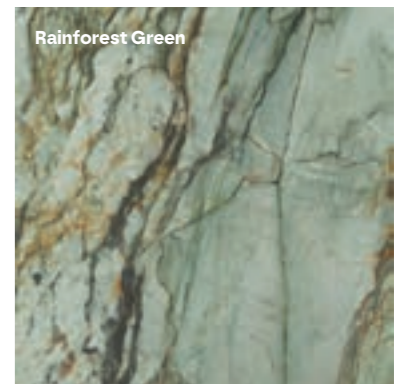

RAINFOREST GREEN



FILATI RAINFOREST GREEN



RAINFOREST GREEN _ FILATI RAINFOREST GREEN _ CROMÁTICA OLIVA _ NORDIK TAUPE _ RULE ALLOY

RAINFOREST GREEN

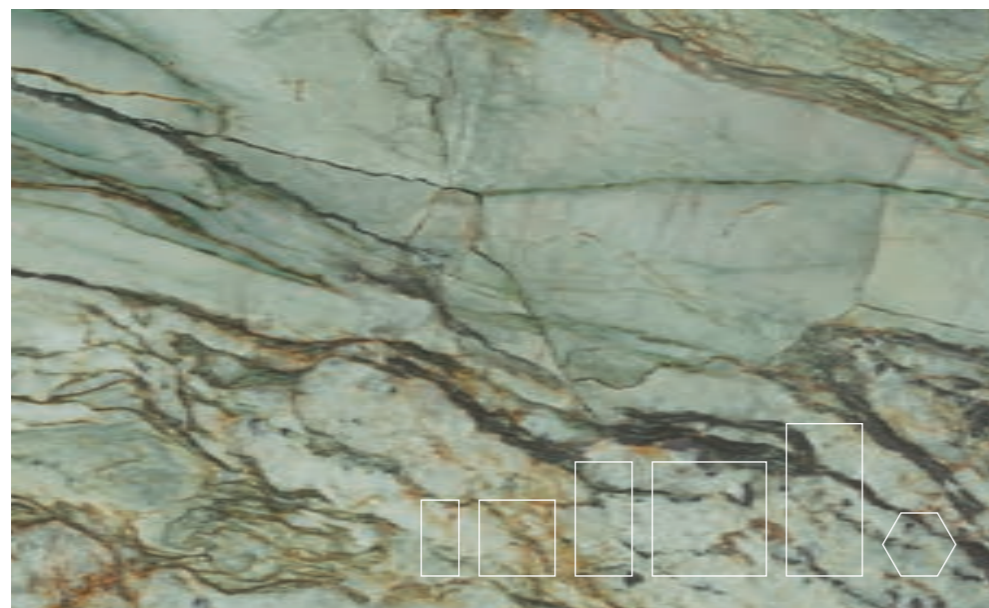

RAINFOREST GREEN

311B214V01	29,5x59,2x0,98 cm	MATT RECT	P91
3112214V01	29,5x59,2x0,98 cm	POL	P105
311B134V01	59,2x59,2x0,98 cm	MATT RECT	P91
3112134V01	59,2x59,2x0,98 cm	POL	P105
311BH84V01	44,35x88,9x1,05 cm	MATT RECT	P99
3112H84V01	44,35x88,9x1,05 cm	POL	P112
311BK74V01	88,9x88,9x1,05 cm	MATT RECT	P104
3112K74V01	88,9x88,9x1,05 cm	POL	P116
311BD34V01	59,2x118,6x0,98 cm	MATT RECT	P104
3112D34V01	59,2x118,6x0,98 cm	POL	P116

HEXAGONO RAINFOREST GREEN (*)

331BV08V71	50,4x58,2x0,98 cm	MATT RECT	P209
3312V08V71	50,4x58,2x0,98 cm	POL	P245



FILATI RAINFOREST GREEN (***)

331B6A0W31	14x59x0,98 cm	MATT RECT	P14 /peça_piece
33126A0W31	14x59x0,98 cm	POL	P14 /peça_piece

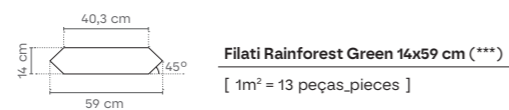
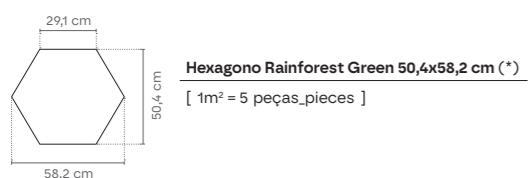

(*) Peças produzidas de acordo com quantidades mínimas de 10m².
 (*) Pieces produced in minimum quantities of 10m².
 (*) Pièces produites selon des quantités minimales de 10m².
 (*) Piezas producidas en cantidades mínimas de 10m².

(***) Peças produzidas de acordo com quantidades mínimas de 10 peças.
 (***) Pieces produced in minimum quantities of 10 pieces.
 (***) Pièces produites selon des quantités minimales de 10 pièces.
 (***) Piezas producidas en cantidades mínimas de 10 piezas.



29,5x59,2 · 59,2x59,2 · 59,2x118,6 · 44,35x88,9 · 88,9x88,9 cm	MATT RECT	V4	3	class 1	≥0,42
29,5x59,2 · 59,2x59,2 · 59,2x118,6 · 44,35x88,9 · 88,9x88,9 cm	POL	V4	2	-	-

RAINFOREST GREEN

RAINFOREST GREEN



JUNGLE 1 (e)

3312D33W61 59,2x118,6x0,98 cm POL P257 /peça_pieça



JUNGLE 2 (e)

3312D33W71 59,2x118,6x0,98 cm POL P257 /peça_pieça



RAINFOREST GREEN

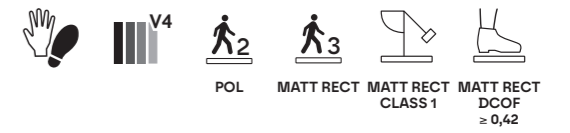

POL MATT RECT CLASS 1 MATT RECT DCOF ≥ 0,42

	PEÇAS · PIECES		CAIXA · BOX			EUROPALETE · EUROPALLET		
		±	PZ	M ²	KG	CX	M ²	KG
29,5x59,2 cm	MATT RECT	9,8 ±5%	8	1.40	33.20	32	44.80	1 083
	POL	9,8 ±5%	8	1.40	33.20	32	44.80	1 083
59,2x59,2 cm	MATT RECT	9,8 ±5%	4	1.40	33.00	32	44.80	1 077
	POL	9,8 ±5%	4	1.40	33.00	32	44.80	1 077
50,4x58,2 cm	MATT RECT	9,8 ±5%	4	0.88	20.20	32	28.16	667
	POL	9,8 ±5%	4	0.88	20.20	32	28.16	667
44,35x88,9 cm	MATT RECT	10,5 ±0,5mm	4	1.58	38.00	24	37.92	967
	POL	10,5 ±0,5mm	4	1.58	38.00	24	37.92	967
88,9x88,9 cm	MATT RECT	10,5 ±0,5mm	2	1.58	38.00	24	37.92	967
	POL	10,5 ±0,5mm	2	1.58	38.00	24	37.92	967
59,2x118,6 cm	MATT RECT	9,8 ±5%	2	1.40	33.00	30	42.00	1 011
	POL	9,8 ±5%	2	1.40	33.00	27	37.80	912

PEÇA · PIECE			PEÇA · PIECE			PEÇA · PIECE			PEÇA · PIECE			PEÇA · PIECE		
DG	MATT RECT	POL	RB	MATT RECT	POL	DG CF	MATT RECT	POL	DG CF SS	MATT RECT	POL	DG CF CANTO	MATT RECT	POL
29,5x59,2 cm	P18	P18	9,5x29,5 cm	P08	P08	29,5x59,2 cm	P157	P157	29,5x59,2 cm	P157	P157	29,5x59,2 cm	P207	P207
59,2x59,2 cm	P36	P36	8x44,35 cm	P16	P16									
44,35x88,9 cm	P96	P96	8x59,2 cm	P12	P12									
29,5x118,6 cm	P96	P96	8x88,9 cm	P28	P28									
59,2x118,6 cm	P167	P167	8x118,6 cm	P28	P28									

DG CF / DG CF Canto/DG CF SS: Peças produzidas sob encomenda. Altura do focinho: entre 3 cm e 10 cm. Indicar a altura pretendida no ato da encomenda.
 DG CF / DG CF Canto/DG CF SS: Pieces produced on order. Trim height: 3 to 10 cm. Specify desired height when placing a order.
 DG CF / DG CF Canto/DG CF SS: Pièces produites sur commande. Hauteur du nez de marche : entre 3 cm et 10 cm. Préciser la hauteur souhaitée lors de la commande.
 DG CF / DG CF Canto/DG CF SS: Piezas producidas por encargo. Altura del ángulo: entre 3 y 10 cm. Indicar la altura deseada al realizar el pedido.

DG CF Canto: Disponível em canto esquerdo e direito.
 DG CF Canto: Available in left and right corner.
 DG CF Canto: Disponible en angle gauche et droit.
 DG CF Canto: Canto izquierdo y derecho disponibles.

ESQUEMA DE APLICAÇÃO:
 APPLICATION SCHEMA:
 SCHEMA D'APPLICATION:
 ESQUEMA DE APLICACIÓN:

JUNGLE 1	JUNGLE 2	JUNGLE 1
JUNGLE 1	JUNGLE 2	JUNGLE 1

JUNGLE 1 - 4 peças_pieças
 JUNGLE 2 - 2 peças_pieças

JUNGLE 1	JUNGLE 2	JUNGLE 1	JUNGLE 2
JUNGLE 1	JUNGLE 2	JUNGLE 1	JUNGLE 2

JUNGLE 1 - 4 peças_pieças
 JUNGLE 2 - 4 peças_pieças

GRAPHIC VARIATION

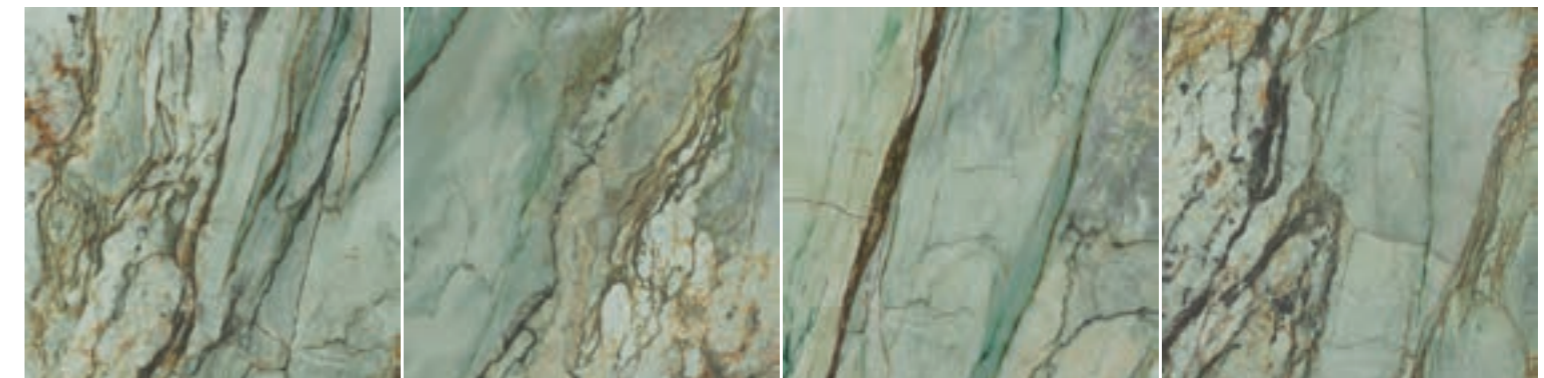

De modo a proteger a superfície das peças, os produtos no acabamento polido têm uma fina camada de impermeabilizante, que apenas deve ser removida após a conclusão da obra.
 Tiles with polished finish are protected with waterproof coating that must be removed only after the works are concluded.
 En vue de protéger la surface des pièces, les produits à la finition polie ont une fine couche d'imperméabilisant qui ne devrait être enlevée qu'après l'achèvement des travaux.
 Con el fin de proteger la superficie de las piezas, los productos con acabado pulido tienen una fina capa de impermeabilizante, que solo debe eliminarse una vez terminado el trabajo.

Tendo em vista alcançar um efeito global mais real e harmonioso, são produzidas peças diferentes umas das outras com variações de desenho e/ou cores entre elas.
 For a more genuine and harmonious effect overall, different tiles with design and/or colour variations are produced.
 Afin d'obtenir un effet global plus réel et harmonieux, nos pièces sont différentes les unes des autres avec des variations de dessin et / ou de nuances entre elles.
 Para lograr un efecto global más real y armonioso, se producen piezas diferentes unas de otras con variaciones de diseño y/o color.



ONIX GOLD

MARBLES

ONIX GOLD



1 cor colour couleur color 6 formatos formats formats 2 acabamentos finishes finitions acabados

Majestoso mármore de tom branco matizado de tons cálidos, numa entropia concertada de efeitos glamorosos.

Majestic white marble tinged with warm shades, in a concerted entropy of glamorous effects.

Majestueux marbre blanc teinté de nuances chaudes dans une entropie concertée d'effets glamouroux.

Majestuoso mármol de tono blanco matizado con tonos cálidos, em uma entropia concertada de efectos glamurosos.

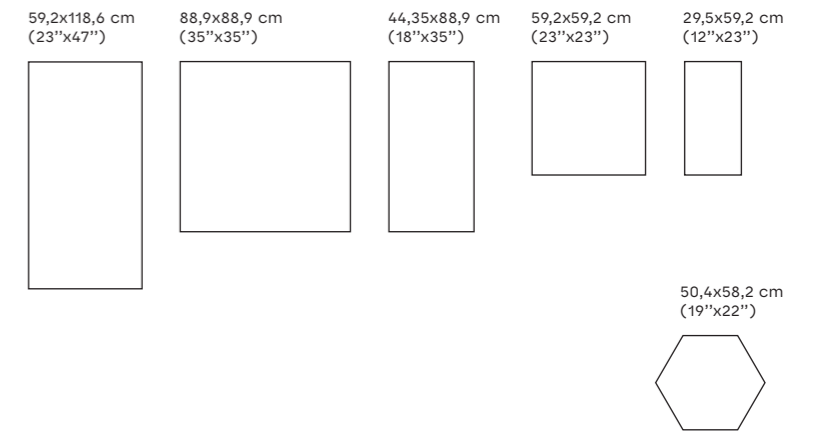

MATT RECT · POL

15
Até 15 desenhos
Up to 15 designs
Jusqu'à 15 dessins
Hasta 15 diseños

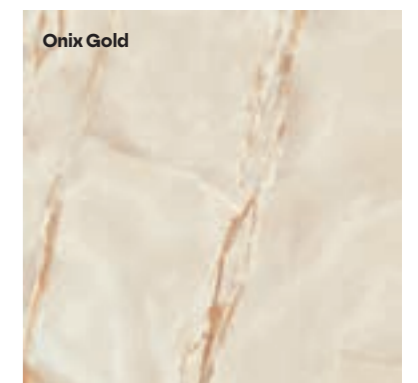

ONIX GOLD



MARBLES

303

revigres



MARBLES

302

revigres

ONIX GOLD _ INLAY GOLD _ CROMÁTICA TERRACOTTA

ONIX GOLD



ONIX GOLD

311B213V81	29,5x59,2x0,98 cm	MATT RECT	P91
3112213V81	29,5x59,2x0,98 cm	POL	P105
311B133V81	59,2x59,2x0,98 cm	MATT RECT	P91
3112133V81	59,2x59,2x0,98 cm	POL	P105
311BH83V81	44,35x88,9x1,05 cm	MATT RECT	P99
3112H83V81	44,35x88,9x1,05 cm	POL	P112
311BK73V81	88,9x88,9x1,05 cm	MATT RECT	P104
3112K73V81	88,9x88,9x1,05 cm	POL	P116
311BD33V81	59,2x118,6x0,98 cm	MATT RECT	P104
3112D33V81	59,2x118,6x0,98 cm	POL	P116

HEXAGONO ONIX GOLD (*)

331BV08V61	50,4x58,2x0,98 cm	MATT RECT	P209
3312V08V61	50,4x58,2x0,98 cm	POL	P245

ONIX GOLD

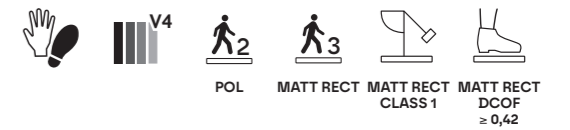

	PEÇAS · PIECES		CAIXA · BOX			EUROPALETE · EUROPALLET		
		±	PZ	M ²	KG	CX	M ²	KG
29,5x59,2 cm	MATT RECT	9,8 ±5%	8	1.40	33.20	32	44.80	1 083
	POL	9,8 ±5%	8	1.40	33.20	32	44.80	1 083
59,2x59,2 cm	MATT RECT	9,8 ±5%	4	1.40	33.00	32	44.80	1 077
	POL	9,8 ±5%	4	1.40	33.00	32	44.80	1 077
50,4x58,2 cm	MATT RECT	9,8 ±5%	4	0.88	20.20	32	28.16	667
	POL	9,8 ±5%	4	0.88	20.20	32	28.16	667
44,35x88,9 cm	MATT RECT	10,5 ±0,5mm	4	1.58	38.00	24	37.92	967
	POL	10,5 ±0,5mm	4	1.58	38.00	24	37.92	967
88,9x88,9 cm	MATT RECT	10,5 ±0,5mm	2	1.58	38.00	24	37.92	967
	POL	10,5 ±0,5mm	2	1.58	38.00	24	37.92	967
59,2x118,6 cm	MATT RECT	9,8 ±5%	2	1.40	33.00	30	42.00	1 011
	POL	9,8 ±5%	2	1.40	33.00	27	37.80	912



FILATI ONIX GOLD (***)

331B6A0W31	14x59x0,98 cm	MATT RECT	P14 /peça_pieza
33126A0W31	14x59x0,98 cm	POL	P14 /peça_pieza



INLAY GOLD (a)(b)(e)

33125A0W01	27x35x0,98 cm	POL	P25 /peça_pieza
------------	---------------	-----	-----------------

[1m² = 14 peças_pieces]

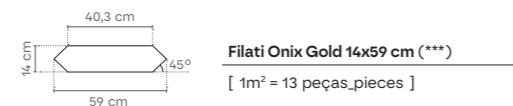
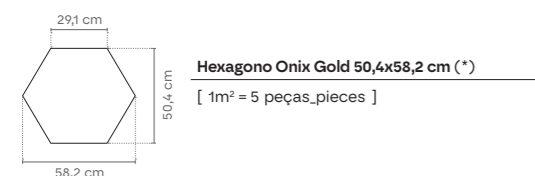

29,5x59,2 · 59,2x59,2 · 59,2x118,6 · 44,35x88,9 · 88,9x88,9 cm	MATT RECT	V4	3	class 1	≥0,42
29,5x59,2 · 59,2x59,2 · 59,2x118,6 · 44,35x88,9 · 88,9x88,9 cm	POL	V4	2	-	-

(*) Peças produzidas de acordo com quantidades mínimas de 10m².
 (*) Pieces produced in minimum quantities of 10m².
 (*) Pièces produites selon des quantités minimales de 10m².
 (*) Piezas producidas en cantidades mínimas de 10m².

(***) Peças produzidas de acordo com quantidades mínimas de 10 peças.
 (***) Pieces produced in minimum quantities of 10 pieces.
 (***) Pièces produites selon des quantités minimales de 10 pièces.
 (***) Piezas producidas en cantidades mínimas de 10 piezas.

PEÇA · PIECE			PEÇA · PIECE			PEÇA · PIECE			PEÇA · PIECE			PEÇA · PIECE		
DG	MATT RECT	POL	RB	MATT RECT	POL	DG CF	MATT RECT	POL	DG CF SS	MATT RECT	POL	DG CF CANTO	MATT RECT	POL
29,5x59,2 cm	P18	P18	9,5x29,5 cm	P08	P08	29,5x59,2 cm	P157	P157	29,5x59,2 cm	P157	P157	29,5x59,2 cm	P207	P207
59,2x59,2 cm	P36	P36	8x44,35 cm	P16	P16									
44,35x88,9 cm	P96	P96	8x59,2 cm	P12	P12									
29,5x118,6 cm	P96	P96	8x88,9 cm	P28	P28									
59,2x118,6 cm	P167	P167	8x118,6 cm	P28	P28									

DG CF / DG CF Canto/DG CF SS: Peças produzidas sob encomenda. Altura do focinho: entre 3 cm e 10 cm. Indicar a altura pretendida no ato da encomenda.
 DG CF / DG CF Canto/DG CF SS: Pieces produced on order. Trim height: 3 to 10 cm. Specify desired height when placing a order.
 DG CF / DG CF Canto/DG CF SS: Pièces produites sur commande. Hauteur du nez de marche : entre 3 cm et 10 cm. Préciser la hauteur souhaitée lors de la commande.
 DG CF / DG CF Canto/DG CF SS: Piezas producidas por encargo. Altura del ángulo: entre 3 y 10 cm. Indicar la altura deseada al realizar el pedido.

DG CF Canto: Disponível em canto esquerdo e direito.
 DG CF Canto: Available in left and right corner.
 DG CF Canto: Disponible en angle gauche et droit.
 DG CF Canto: Canto izquierdo y derecho disponibles.

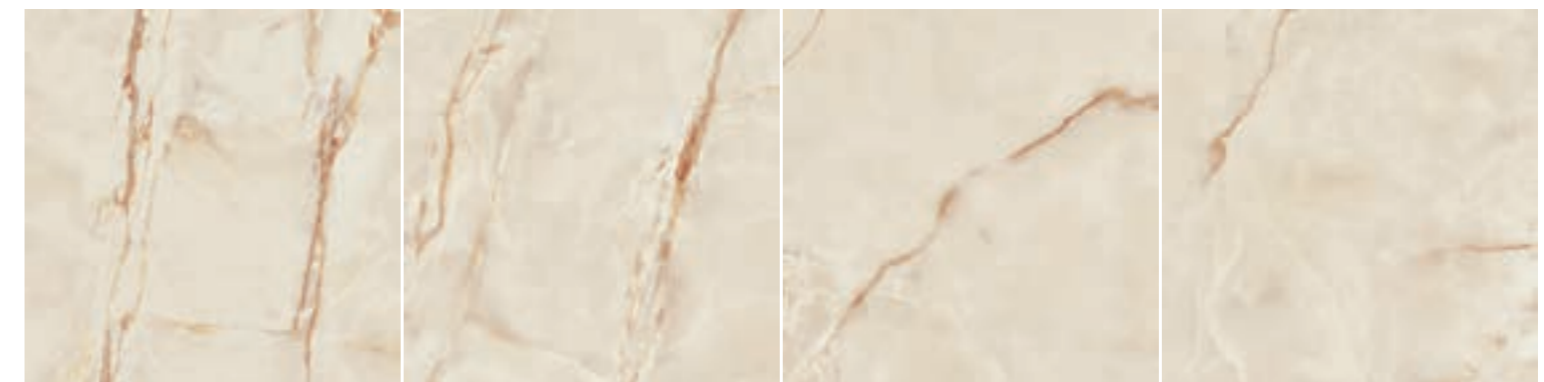

De modo a proteger a superfície das peças, os produtos no acabamento polido têm uma fina camada de impermeabilizante, que apenas deve ser removida após a conclusão da obra.
 Tiles with polished finish are protected with waterproof coating that must be removed only after the works are concluded.
 En vue de protéger la surface des pièces, les produits à la finition polie ont une fine couche d'imperméabilisant qui ne devrait être enlevée qu'après l'achèvement des travaux.
 Con el fin de proteger la superficie de las piezas, los productos con acabado pulido tienen una fina capa de impermeabilizante, que solo debe eliminarse una vez terminado el trabajo.

Tendo em vista alcançar um efeito global mais real e harmonioso, são produzidas peças diferentes umas das outras com variações de desenho e/ou cores entre elas.
 For a more genuine and harmonious effect overall, different tiles with design and/or colour variations are produced.
 Afin d'obtenir un effet global plus réel et harmonieux, nos pièces sont différentes les unes des autres avec des variations de dessin et / ou de nuances entre elles.
 Para lograr un efecto global más real y armonioso, se producen piezas diferentes unas de otras con variaciones de diseño y/o color.



EMPERADOR BROWN _ STATUARIO WHITE _ JINKO NUDE

MARBLES

EMPERADOR BROWN



- 1 cor
colour
couleur
color
- 5 formatos
formats
formats
formats
- 2 acabamentos
finishes
finitions
acabados

O efeito da pedra natural enriquecida com cor para preencher os espaços com emoções fortes.

The effect of natural stone enriched with colour to complete space with strong emotions.

L'effet de la pierre naturelle enrichie de couleur pour remplir les espaces d'émotions fortes.

El efecto de la piedra natural enriquecida con color para llenar los espacios con emociones fuertes.

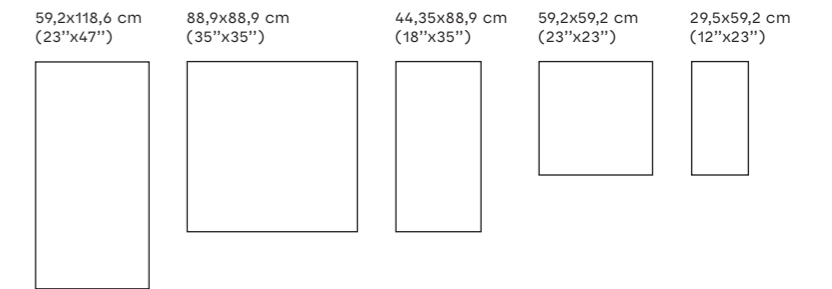

MATT RECT · POL

8

Até 8 desenhos
Up to 8 designs
Jusqu'à 8 dessins
Hasta 8 diseños



EMPERADOR BROWN

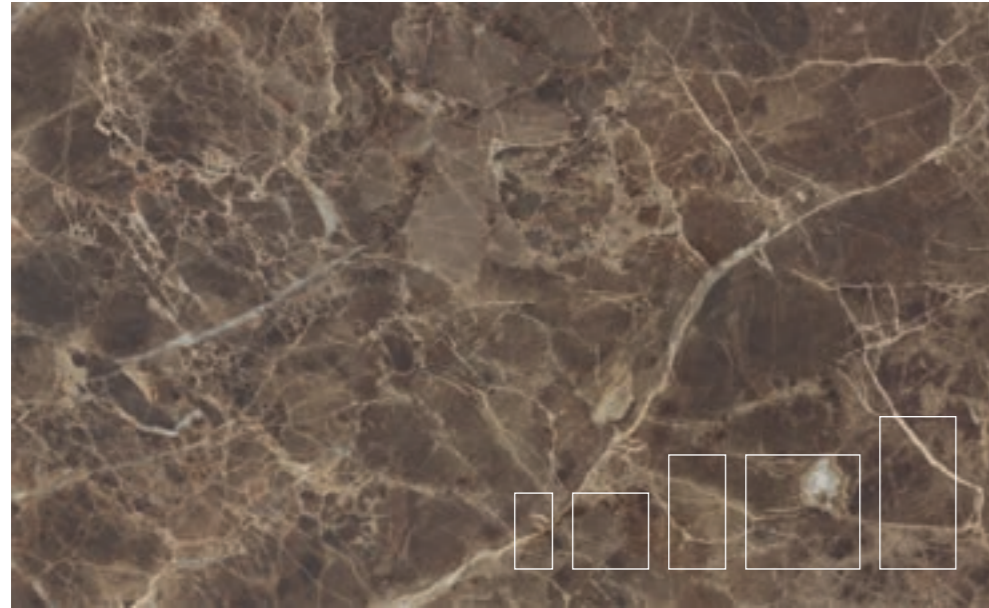

EMPERADOR BROWN

Code	Dimensions	Finish	Product Code
311121U891	29,5x59,2x0,98 cm	MATT RECT	P91
311221U891	29,5x59,2x0,98 cm	POL	P105
311113U891	59,2x59,2x0,98 cm	MATT RECT	P91
311213U891	59,2x59,2x0,98 cm	POL	P105
311BH8U891	44,35x88,9x1,05 cm	MATT RECT	P99
3112H821X1	44,35x88,9x1,05 cm	POL	P112
311BK7U891	88,9x88,9x1,05 cm	MATT RECT	P104
3112K7U891	88,9x88,9x1,05 cm	POL	P116
311BD3U891	59,2x118,6x0,98 cm	MATT RECT	P104
3112D3U891	59,2x118,6x0,98 cm	POL	P116



Dimensions	Finish	V3	class 1	≥0,42
29,5x59,2 · 59,2x59,2 · 44,35x88,9 · 88,9x88,9 · 59,2x118,6 cm	MATT RECT	V3	3	class 1
29,5x59,2 · 59,2x59,2 · 44,35x88,9 · 88,9x88,9 · 59,2x118,6 cm	POL	V3	3	-

EMPERADOR BROWN

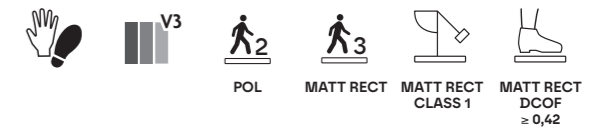

Dimensions	PEÇAS · PIECES	CAIXA · BOX			EUROPALETTE · EUROPALLET			
		PZ	M²	KG	CX	M²	KG	
29,5x59,2 cm	MATT RECT	9,8 ±5%	8	1.40	33.20	32	44.80	1 083
	POL	9,8 ±5%	8	1.40	33.20	32	44.80	1 083
59,2x59,2 cm	MATT RECT	9,8 ±5%	4	1.40	33.00	32	44.80	1 077
	POL	9,8 ±5%	4	1.40	33.00	32	44.80	1 077
44,35x88,9 cm	MATT RECT	10,5 ±0,5mm	4	1.58	38.00	24	37.92	967
	POL	10,5 ±0,5mm	4	1.58	38.00	24	37.92	967
88,9x88,9 cm	MATT RECT	10,5 ±0,5mm	2	1.58	38.00	24	37.92	967
	POL	10,5 ±0,5mm	2	1.58	38.00	24	37.92	967
59,2x118,6 cm	MATT RECT	9,8 ±5%	2	1.40	33.00	30	42.00	1 011
	POL	9,8 ±5%	2	1.40	33.00	27	37.80	912

Diagram	PEÇA · PIECE	Diagram	PEÇA · PIECE	Diagram	PEÇA · PIECE	Diagram	PEÇA · PIECE	Diagram	PEÇA · PIECE
	DG MATT RECT POL		RB MATT RECT POL		DG CF MATT RECT POL		DG CF SS MATT RECT POL		DG CF CANTO MATT RECT POL
29,5x59,2 cm	P18 P18	9,5x29,5 cm	P08 P08	29,5x59,2 cm	P157 P157	29,5x59,2 cm	P157 P157	29,5x59,2 cm	P207 P207
59,2x59,2 cm	P36 P36	8x44,35 cm	P16 P16						
44,35x88,9 cm	P96 P96	8x59,2 cm	P12 P12						
29,5x118,6 cm	P96 P96	8x88,9 cm	P28 P28						
59,2x118,6 cm	P167 P167	8x118,6 cm	P28 P28						

DG CF / DG CF Canto/DG CF SS: Peças produzidas sob encomenda. Altura do focinho: entre 3 cm e 10 cm. Indicar a altura pretendida no ato da encomenda.

DG CF / DG CF Canto/DG CF SS: Pieces produced on order. Trim height: 3 to 10 cm. Specify desired height when placing a order.

DG CF / DG CF Canto/DG CF SS: Pièces produites sur commande. Hauteur du nez de marche : entre 3 cm et 10 cm. Préciser la hauteur souhaitée lors de la commande.

DG CF / DG CF Canto/DG CF SS: Piezas producidas por encargo. Altura del ángulo: entre 3 y 10 cm. Indicar la altura deseada al realizar el pedido.

DG CF Canto: Disponível em canto esquerdo e direito.

DG CF Canto: Available in left and right corner.

DG CF Canto: Disponible en angle gauche et droit.

DG CF Canto: Canto izquierdo y derecho disponibles.

GRAPHIC VARIATION

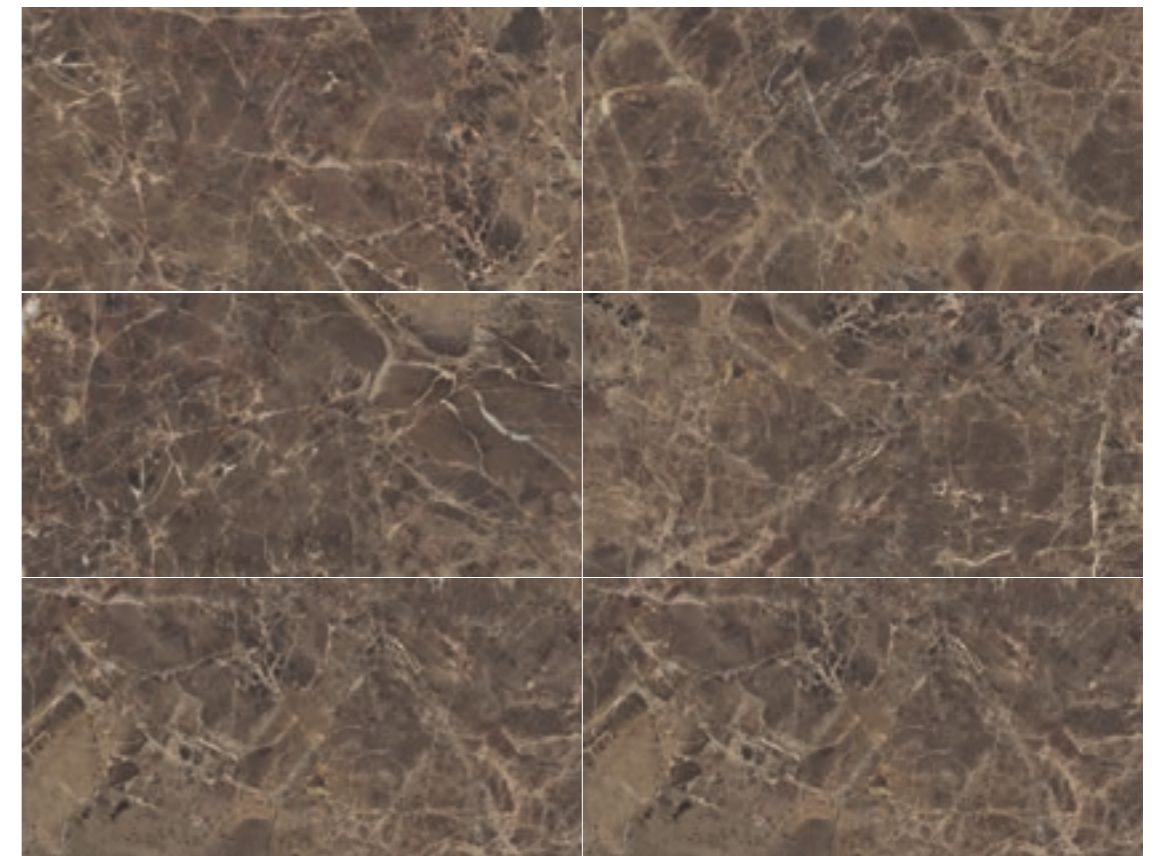

De modo a proteger a superfície das peças, os produtos no acabamento polido têm uma fina camada de impermeabilizante, que apenas deve ser removida após a conclusão da obra.
 Tiles with polished finish are protected with waterproof coating that must be removed only after the works are concluded.
 En vue de protéger la surface des pièces, les produits à la finition polie ont une fine couche d'imperméabilisant qui ne devrait être enlevée qu'après l'achèvement des travaux.
 Con el fin de proteger la superficie de las piezas, los productos con acabado pulido tienen una fina capa de impermeabilizante, que solo debe eliminarse una vez terminado el trabajo.
 Tendo em vista alcançar um efeito global mais real e harmonioso, são produzidas peças diferentes umas das outras com variações de desenho e/ou cores entre elas.
 For a more genuine and harmonious effect overall, different tiles with design and/or colour variations are produced.
 Afin d'obtenir un effet global plus réel et harmonieux, nos pièces sont différentes les unes des autres avec des variations de dessin et / ou de nuances entre elles.
 Para lograr un efecto global más real y armonioso, se producen piezas diferentes unas de otras con variaciones de diseño y/o color.



BALTIC GREY _ PYRAMID GREY

MARBLES

BALTIC GREY



- 1 cor
colour
couleur
color
- 5 formatos
formats
formats
formats
- 2 acabamentos
finishes
finitions
acabados

O efeito enredado dos veios do mármore natural permite criar espaços nobres e intensos, com uma elegância informal.

The mesh effect of natural marble veins helps create noble and intense space with informal elegance.

L'effet emmêlé des veines du marbre naturel permet de créer des espaces nobles et intenses, avec une élégance informelle.

El efecto enredado de las vetas del mármol natural permite crear espacios nobles e intensos, con una elegancia informal.

- 59,2x118,6 cm
(23"x47")
- 88,9x88,9 cm
(35"x35")
- 44,35x88,9 cm
(18"x35")
- 59,2x59,2 cm
(23"x23")
- 29,5x59,2 cm
(12"x23")

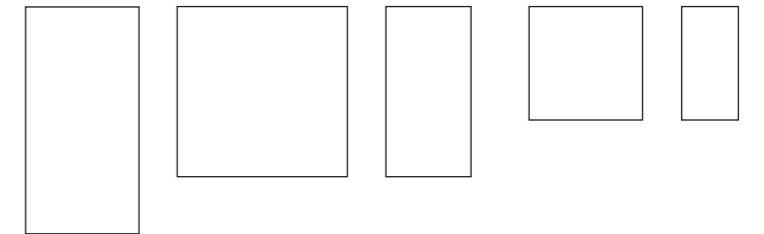

MATT RECT · POL

16

Até 16 desenhos
Up to 16 designs
Jusqu'à 16 dessins
Hasta 16 diseños



BALTIC GREY

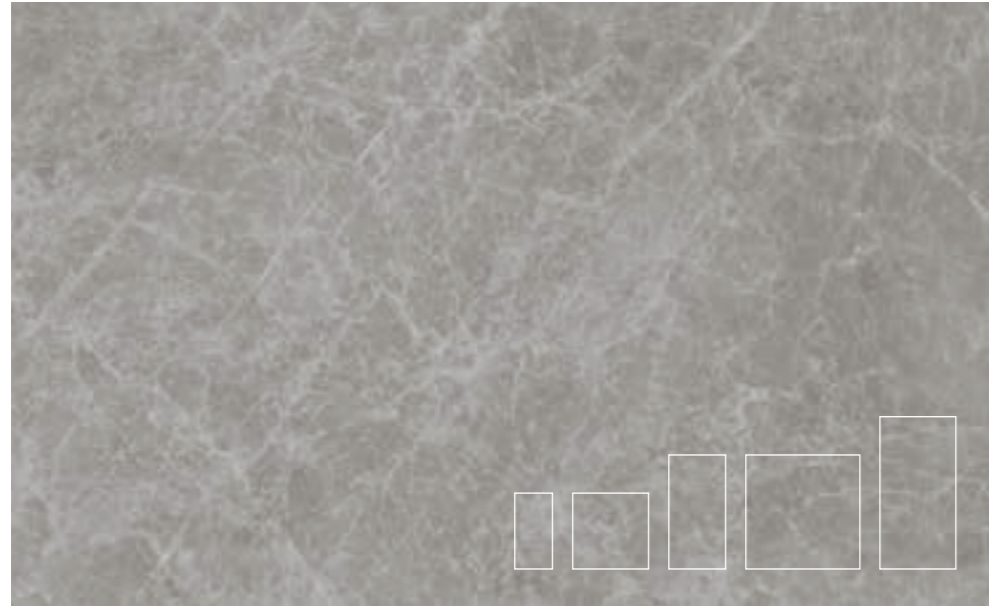

BALTIC GREY

311B219U01	29,5x59,2x0,98 cm	MATT RECT	P91
3112219U01	29,5x59,2x0,98 cm	POL	P105
311B139U01	59,2x59,2x0,98 cm	MATT RECT	P91
3112139U01	59,2x59,2x0,98 cm	POL	P105
311BH89U01	44,35x88,9x1,05 cm	MATT RECT	P99
3112H820X1	44,35x88,9x1,05 cm	POL	P112
311BK79U01	88,9x88,9x1,05 cm	MATT RECT	P104
3112K79U01	88,9x88,9x1,05 cm	POL	P116
311BD39U01	59,2x118,6x0,98 cm	MATT RECT	P104
3112D39U01	59,2x118,6x0,98 cm	POL	P116

BALTIC GREY

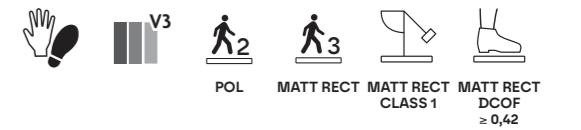

	PEÇAS · PIECES		CAIXA · BOX			EUROPALETTE · EUROPALLET		
		±	PZ	M²	KG	CX	M²	KG
29,5x59,2 cm	MATT RECT	9,8 ±5%	8	1.40	33.20	32	44.80	1 083
	POL	9,8 ±5%	8	1.40	33.20	32	44.80	1 083
59,2x59,2 cm	MATT RECT	9,8 ±5%	4	1.40	33.00	32	44.80	1 077
	POL	9,8 ±5%	4	1.40	33.00	32	44.80	1 077
44,35x88,9 cm	MATT RECT	10,5 ±0,5mm	4	1.58	38.00	24	37.92	967
	POL	10,5 ±0,5mm	4	1.58	38.00	24	37.92	967
88,9x88,9 cm	MATT RECT	10,5 ±0,5mm	2	1.58	38.00	24	37.92	967
	POL	10,5 ±0,5mm	2	1.58	38.00	24	37.92	967
59,2x118,6 cm	MATT RECT	9,8 ±5%	2	1.40	33.00	30	42.00	1 011
	POL	9,8 ±5%	2	1.40	33.00	27	37.80	912



TARSUS (a)(b)(d)(f)

Base: Baltic Grey + Statuario White
 331BG1X141 29x29x0,98 cm P36 /peça_piece
 [1m² = 12 peças_pieces]

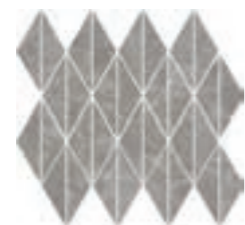

PYRAMID GREY (a)(b)(d)(f)

331BS9X161 29x30x0,98 cm P26 /peça_piece
 [1m² = 18 peças_pieces]



PYRAMID BLACK & GREY (a)(b)(d)

Base: Absolut Black + Baltic Grey
 331BS9X171 29x30x0,98 cm P28 /peça_piece
 [1m² = 18 peças_pieces]



BYZANTINE (a)(b)(d)

Base: Absolut Black + Baltic Grey + Statuario White
 331BS6X151 30x52x0,98 cm P32 /peça_piece
 [1m² = 9 peças_pieces]



29,5x59,2 · 59,2x59,2 · 44,35x88,9 · 88,9x88,9 · 59,2x118,6 cm	MATT RECT	V3	3	class 1	≥0,42
29,5x59,2 · 59,2x59,2 · 44,35x88,9 · 88,9x88,9 · 59,2x118,6 cm	POL	V3	2	-	-

PEÇA · PIECE	PEÇA · PIECE		PEÇA · PIECE		PEÇA · PIECE		PEÇA · PIECE	
		±		±		±		±
DG	MATT RECT	POL	RB	MATT RECT	POL	DG CF	MATT RECT	POL
29,5x59,2 cm	P18	P18	9,5x29,5 cm	P08	P08	29,5x59,2 cm	P157	P157
59,2x59,2 cm	P36	P36	8x44,35 cm	P16	P16			
44,35x88,9 cm	P96	P96	8x59,2 cm	P12	P12	DG CF SS	MATT RECT	POL
29,5x118,6 cm	P96	P96	8x88,9 cm	P28	P28	29,5x59,2 cm	P157	P157
59,2x118,6 cm	P167	P167	8x118,6 cm	P28	P28	DG CF CANTO	MATT RECT	POL
						29,5x59,2 cm	P207	P207

DG CF / DG CF Canto/DG CF SS: Peças produzidas sob encomenda. Altura do flocinho: entre 3 cm e 10 cm. Indicar a altura pretendida no ato da encomenda.
 DG CF / DG CF Canto/DG CF SS: Pieces produced on order. Trim height: 3 to 10 cm. Specify desired height when placing a order.
 DG CF / DG CF Canto/DG CF SS: Pièces produites sur commande. Hauteur du nez de marche : entre 3 cm et 10 cm. Préciser la hauteur souhaitée lors de la commande.
 DG CF / DG CF Canto/DG CF SS: Piezas producidas por encargo. Altura del ángulo: entre 3 y 10 cm. Indicar la altura deseada al realizar el pedido.
 DG CF Canto: Disponível em canto esquerdo e direito.
 DG CF Canto: Available in left and right corner.
 DG CF Canto: Disponible en angle gauche et droit.
 DG CF Canto: Canto izquierdo y derecho disponibles.

GRAPHIC VARIATION



De modo a proteger a superfície das peças, os produtos no acabamento polido têm uma fina camada de impermeabilizante, que apenas deve ser removida após a conclusão da obra.
 Tiles with polished finish are protected with waterproof coating that must be removed only after the works are concluded.
 En vue de protéger la surface des pièces, les produits à la finition polie ont une fine couche d'imperméabilisant qui ne devrait être enlevée qu'après l'achèvement des travaux.
 Con el fin de proteger la superficie de las piezas, los productos con acabado pulido tienen una fina capa de impermeabilizante, que solo debe eliminarse una vez terminado el trabajo.
 Tendo em vista alcançar um efeito global mais real e harmonioso, são produzidas peças diferentes umas das outras com variações de desenho e/ou cores entre elas.
 For a more genuine and harmonious effect overall, different tiles with design and/or colour variations are produced.
 Afin d'obtenir un effet global plus réel et harmonieux, nos pièces sont différentes les unes des autres avec des variations de dessin et / ou de nuances entre elles.
 Para lograr un efecto global más real y armonioso, se producen piezas diferentes unas de otras con variaciones de diseño y/o color.



ABSOLUT BLACK _ HEXA STATUARIO

MARBLES

ABSOLUT BLACK



- 1 cor
colour
couleur
color
- 5 formatos
formats
formats
formats
- 2 acabamentos
finishes
finitions
acabados

A profundidade do negro em harmonia com os delicados veios brancos promovem uma elegância única.

Deep black in harmony with the delicate white veins favour a unique elegance.

La profondeur du noir et les délicates veines blanches font ressortir une élégance unique.

La profundidad del negro y las delicadas vetas blancas contribuyen para una elegancia única.

- 59,2x118,6 cm
(23"x47")
- 88,9x88,9 cm
(35"x35")
- 44,35x88,9 cm
(18"x35")
- 59,2x59,2 cm
(23"x23")
- 29,5x59,2 cm
(12"x23")

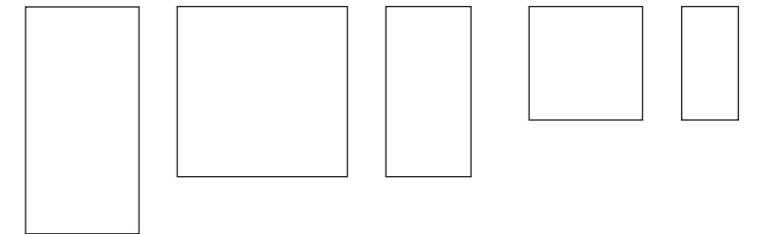

MATT RECT



(*)

POL

10

Até 10 desenhos
Up to 10 designs
Jusqu'à 10 dessins
Hasta 10 diseños



ABSOLUT BLACK



ABSOLUT BLACK MATT RECT

31121U881	29,5x59,2x0,98 cm	MATT RECT	P91
311B13U881	59,2x59,2x0,98 cm	MATT RECT	P91
311BH8U881	44,35x88,9x1,05 cm	MATT RECT	P99
311BK7U881	88,9x88,9x1,05 cm	MATT RECT	P104
311BD3U881	59,2x118,6x0,98 cm	MATT RECT	P104



ABSOLUT BLACK POL (*)

311221U881	29,5x59,2x0,98 cm	POL (*)	P105
311213U881	59,2x59,2x0,98 cm	POL (*)	P105
3112H8U881	44,35x88,9x1,05 cm	POL (*)	P112
3112K7U881	88,9x88,9x1,05 cm	POL (*)	P116
3112D3U881	59,2x118,6x0,98 cm	POL (*)	P116

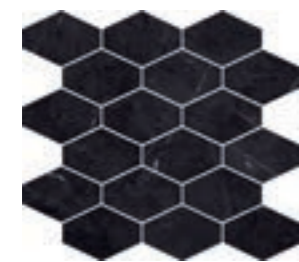

MODULUS ABSOLUT (a)(b)(d)

3311S28Y71	33x37x0,98 cm	P32 /peça_pieza
[1m² = 11 peças_pieças]		



PEAK ABSOLUT (a)(b)(d)

Base: Absoluto Black + Statuario White

3311129Y01	30x30x0,98 cm	P32 /peça_pieza
[1m² = 14 peças_pieças]		



HEXA STATUARIO (a)(b)(d)

Base: Absoluto Black + Statuario White

3311S18Y91	24x30x0,98 cm	P32 /peça_pieza
[1m² = 22 peças_pieças]		

(*) ABSOLUT BLACK POL - Produto para aplicação em revestimento. Não pode ser aplicado em pavimento. Não devem ser utilizados utensílios ou produtos de limpeza abrasivos, os quais poderão danificar o produto.

(*) ABSOLUT BLACK POL - For use on walls. Do not apply on floors. Do not use tools, acid and/or abrasive cleaning products, which may damage the tiles.

(*) ABSOLUT BLACK POL - Produit pour application sur les revêtements muraux. Il ne peut pas être appliqué sur les sols. Les ustensiles ou produits de nettoyage abrasifs ne doivent pas être utilisés, car ils pourraient endommager le produit.

(*) ABSOLUT BLACK POL - Producto para aplicar en revestimientos. No se puede aplicar en pavimentos. No se deben utilizar productos ni utensilios de limpieza abrasivos, ya que podrían dañar el producto.

29,5x59,2 - 44,35x88,9 - 88,9x88,9 - 59,2x118,6 cm	MATT RECT	V3	3	class 1	≥0,42
59,2x59,2 cm	MATT RECT	V3	3	class 1	≥0,42

De modo a proteger a superfície das peças, os produtos no acabamento polido têm uma fina camada de impermeabilizante, que apenas deve ser removida após a conclusão da obra.
Tiles with polished finish are protected with waterproof coating that must be removed only after the works are concluded.

En vue de protéger la surface des pièces, les produits à la finition polie ont une fine couche d'imperméabilisant qui ne devrait être enlevée qu'après l'achèvement des travaux.

Con el fin de proteger la superficie de las piezas, los productos con acabado pulido tienen una fina capa de impermeabilizante, que solo debe eliminarse una vez terminado el trabajo.

Tendo em vista alcançar um efeito global mais real e harmonioso, são produzidas peças diferentes umas das outras com variações de desenho e/ou cores entre elas.

For a more genuine and harmonious effect overall, different tiles with design and/or colour variations are produced.

Afin d'obtenir un effet global plus réel et harmonieux, nos pièces sont différentes les unes des autres avec des variations de dessin et / ou de nuances entre elles.

Para lograr un efecto global más real y armonioso, se producen piezas diferentes unas de otras con variaciones de diseño y/o color.

ABSOLUT BLACK

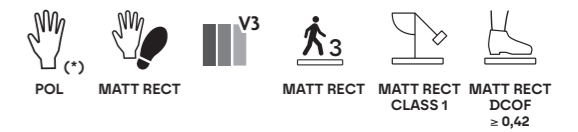

	PEÇAS · PIECES	±	CAIXA · BOX			EUROPALETE · EUROPALLET		
			PZ	M²	KG	CX	M²	KG
29,5x59,2 cm	MATT RECT	9,8 ±5%	8	1.40	33.20	32	44.80	1 083
	POL	9,8 ±5%	8	1.40	33.20	32	44.80	1 083
59,2x59,2 cm	MATT RECT	9,8 ±5%	4	1.40	33.00	32	44.80	1 077
	POL	9,8 ±5%	4	1.40	33.00	32	44.80	1 077
44,35x88,9 cm	MATT RECT	10,5 ±0,5mm	4	1.58	38.00	24	37.92	967
	POL	10,5 ±0,5mm	4	1.58	38.00	24	37.92	967
88,9x88,9 cm	MATT RECT	10,5 ±0,5mm	2	1.58	38.00	24	37.92	967
	POL	10,5 ±0,5mm	2	1.58	38.00	24	37.92	967
59,2x118,6 cm	MATT RECT	9,8 ±5%	2	1.40	33.00	30	42.00	1 011
	POL	9,8 ±5%	2	1.40	33.00	27	37.80	912

PEÇA · PIECE		PEÇA · PIECE		PEÇA · PIECE		PEÇA · PIECE		PEÇA · PIECE	
DG	MATT RECT	RB	MATT RECT	DG CF	MATT RECT	DG CF SS	MATT RECT	DG CF CANTO	MATT RECT
29,5x59,2 cm	P18	9,5x29,5 cm	P08	29,5x59,2 cm	P157	29,5x59,2 cm	P157	29,5x59,2 cm	P207
59,2x59,2 cm	P36	8x44,35 cm	P16						
44,35x88,9 cm	P96	8x59,2 cm	P12						
29,5x118,6 cm	P96	8x88,9 cm	P28						
59,2x118,6 cm	P167	8x118,6 cm	P28						

DG CF Canto: Disponível em canto esquerdo e direito.
DG CF Canto: Available in left and right corner.
DG CF Canto: Disponible en angle gauche et droit.
DG CF Canto: Canto izquierdo y derecho disponibles.

DG CF / DG CF Canto/DG CF SS: Peças produzidas sob encomenda. Altura do focinho: entre 3 cm e 10 cm. Indicar a altura pretendida no ato da encomenda.

DG CF / DG CF Canto/DG CF SS: Pieces produced on order. Trim height: 3 to 10 cm. Specify desired height when placing a order.

DG CF / DG CF Canto/DG CF SS: Pièces produites sur commande. Hauteur du nez de marche : entre 3 cm et 10 cm. Préciser la hauteur souhaitée lors de la commande.

DG CF / DG CF Canto/DG CF SS: Piezas producidas por encargo. Altura del ángulo: entre 3 y 10 cm. Indicar la altura deseada al realizar el pedido.





MARBLES

CALACATTA ORO



1 cor colour couleur color 7 formatos formats formats formats 2 acabamentos finishes finitions acabados

Tonalidades douradas criam ambientes sofisticados e harmoniosos, onde apetece estar e relaxar.

Hints of gold create sophisticated and harmonious environments that are appealing and relaxing.

Des tonalités dorées créent des atmosphères sophistiquées et harmonieuses, où il fait bon vivre et se détendre.

Los tonos dorados crean ambientes sofisticados y armoniosos en los que apetece estar y relajarse.

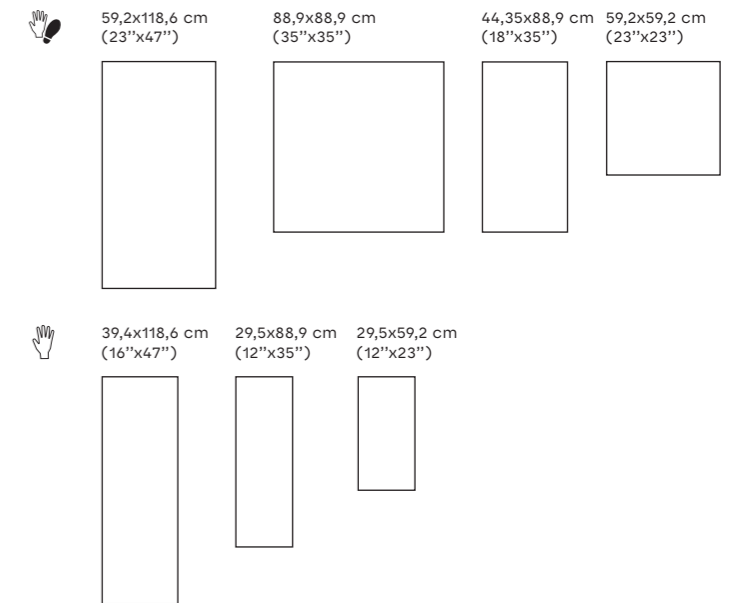

 **MATT RECT · RECT**

 **RECT**

 **16**
Até 16 desenhos
Up to 16 designs
Jusqu'à 16 dessins
Hasta 16 diseños

 **12**
Até 12 desenhos
Up to 12 designs
Jusqu'à 12 dessins
Hasta 12 diseños



CALACATTA ORO

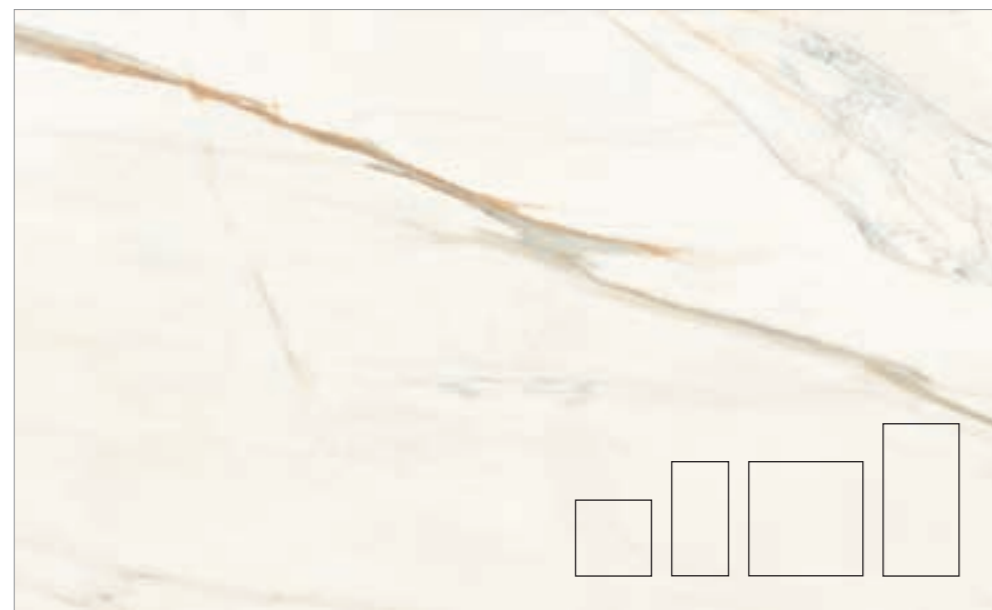
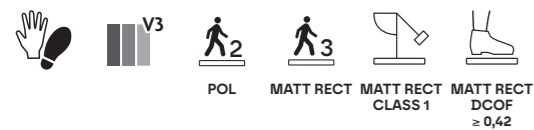

CALACATTA ORO

311B13V861	59,2x59,2x0,98 cm	MATT RECT	P91
311213V861	59,2x59,2x0,98 cm	POL	P105
311BH8V861	44,35x88,9x1,05 cm	MATT RECT	P99
3112H8V861	44,35x88,9x1,05 cm	POL	P112
311BK7V861	88,9x88,9x1,05 cm	MATT RECT	P104
3112K7V861	88,9x88,9x1,05 cm	POL	P116
311BD3V861	59,2x118,6x0,98 cm	MATT RECT	P104
3112D3V861	59,2x118,6x0,98 cm	POL	P116



44,35x88,9 · 59,2x59,2 · 88,9x88,9 · 59,2x118,6 cm	MATT RECT	V3	3	class 1	≥0,42
44,35x88,9 · 59,2x59,2 · 88,9x88,9 · 59,2x118,6 cm	POL	V3	2	-	-

CALACATTA ORO



CALACATTA ORO BRILHO

3101211G51	29,5x59,2x0,90 cm	RECT	P75
3101G81G51	29,5x88,9x1,23 cm	RECT	P92
3101T91G51	39,4x118,6x1,23 cm	RECT	P99



CALACATTA ORO MATE

3101211G81	29,5x59,2x0,90 cm	RECT	P75
3101G81G81	29,5x88,9x1,23 cm	RECT	P92
3101T91G81	39,4x118,6x1,23 cm	RECT	P99



HERRINGBONE CALACATTA ORO (a)(b)(d)

3301U7F571	29x31x0,90 cm	P18 /peça_piece
[1m² = 15 peças_pieces]		



HEXA GOLD CALACATTA (a)(b)(d)(e)

3301S1F581	24x30x0,90 cm	P30 /peça_piece
[1m² = 22 peças_pieces]		

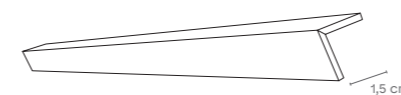

PERFIL	1,5x39,4x1,23 cm	RECT	P28 /peça_piece
--------	------------------	------	-----------------

PERFIL: produzido de acordo com quantidades mínimas de 10 peças.
 PERFIL: produced in minimum quantities of 10 pieces.
 PERFIL: produites selon des quantités minimales de 10 pièces.
 PERFIL: producidas en cantidades mínimas de 10 piezas.



Para o assentamento de peças de grande formato, sugerimos a utilização de niveladores para ajudar a posicionar e nivelar a junta entre peças. Estes acessórios plásticos devem ser utilizados após a aplicação da cola.
 When laying large format tiles, use levelling spacers to ensure proper installing and levelling of tiles. Use the plastic spacers after the adhesive has been applied.
 Pour la pose de pièces de grand format, nous suggérons l'utilisation de croisillons autonivelants pour aider à positionner et à niveler le joint entre les pièces. Ces accessoires en plastique doivent être utilisés après l'application de la colle.
 Para la colocación de piezas de gran tamaño, sugerimos utilizar niveladores para ayudar a colocar y nivelar la junta entre piezas. Estos accesorios plásticos deben utilizarse una vez aplicada la cola.

De modo a proteger a superfície das peças, os produtos no acabamento polido têm uma fina camada de impermeabilizante, que apenas deve ser removida após a conclusão da obra.
 Tiles with polished finish are protected with waterproof coating that must be removed only after the works are concluded.
 En vue de protéger la surface des pièces, les produits à la finition polie ont une fine couche d'imperméabilisant qui ne devrait être enlevée qu'après l'achèvement des travaux.
 Con el fin de proteger la superficie de las piezas, los productos con acabado pulido tienen una fina capa de impermeabilizante, que solo debe eliminarse una vez terminado el trabajo.
 São admissíveis ligeiras diferenças de tonalidade na mesma cor entre os diferentes formatos e tipologias de produto (revestimento cerâmico e grés porcelânico).
 Small differences in shades of the same colour are admissible between different product types (ceramic wall tiles and full body porcelain) and formats.
 De légères différences de tonalité d'une même couleur entre les différents formats et typologies de produits sont admissibles (faïence pâte blanche et grès cérame).
 Se admiten ligeras diferencias de tonalidad en el mismo color entre los diferentes formatos y tipos de producto (revestimiento cerámico y g 188_ res porcelánico).

CALACATTA ORO



TWIGGY ORO BRILHO (e)

3301G8F521 29,5x88,9x1,23 cm RECT P91 /peça_piece



CALACATTA WAVE ORO BRILHO (*)

3101G82G21 29,5x88,9x1,23 cm RECT P94



CALACATTA FLICK ORO MATE (*)

3101G82G31 29,5x88,9x1,23 cm RECT P94

CALACATTA ORO



MARBLES

MARBLES

(*) Dado o efeito deste produto, as peças devem ser aplicadas sempre no mesmo sentido, seguindo a orientação do tardo.
 (*) Given the effect of the product, tiles must always be laid out facing same direction, following the orientation of the back.
 (*) En raison de l'effet de ce produit, les carreaux doivent toujours être posés dans le même sens, en suivant l'orientation de sa face interne.
 (*) Dado el efecto de este producto, las piezas deben aplicarse siempre en el mismo sentido, siguiendo la orientación del dorso.

Tendo em vista alcançar um efeito global mais real e harmonioso, são produzidas peças diferentes umas das outras com variações de desenho e/ou cores entre elas.
 For a more genuine and harmonious effect overall, different tiles with design and/or colour variations are produced.
 Afin d'obtenir un effet global plus réel et harmonieux, nos pièces sont différentes les unes des autres avec des variations de dessin et / ou de nuances entre elles.
 Para lograr un efecto global más real y armonioso, se producen piezas diferentes unas de otras con variaciones de diseño y/o color.

CALACATTA ORO



CALACATTA WIND ORO BRILHO (*)

3101214G11 29,5x59,2x0,90 cm RECT P80



CALACATTA TIARA ORO MATE (*)

3101213G61 29,5x59,2x0,90 cm RECT P80



CALACATTA ORO BRILHO _ CALACATTA TIARA ORO MATE _ MONTANA CHERRY

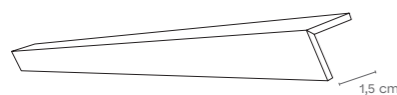

PERFIL		
1,5x29,5x0,90 cm	RECT	P20 /peça_pieza
1,5x59,2x0,90 cm	RECT	P32 /peça_pieza

PERFIL: produzido de acordo com quantidades mínimas de 10 peças.
 PERFIL: produced in minimum quantities of 10 pieces.
 PERFIL: produites selon des quantités minimales de 10 pièces.
 PERFIL: producidas en cantidades mínimas de 10 piezas.

(*) Dado o efeito deste produto, as peças devem ser aplicadas sempre no mesmo sentido, seguindo a orientação do tardo.
 (*) Given the effect of the product, tiles must always be laid out facing same direction, following the orientation of the back.
 (*) En raison de l'effet de ce produit, les carreaux doivent toujours être posés dans le même sens, en suivant l'orientation de sa face interne.
 (*) Dado el efecto de este producto, las piezas deben aplicarse siempre en el mismo sentido, siguiendo la orientación del dorso.

CALACATTA ORO



PEÇAS · PIECES			CAIXA · BOX			EUROPALETTE · EUROPALLET		
		±	PZ	M ²	KG	CX	M ²	KG
29,5x59,2 cm	RECT	9,0 ±5%	8	1.40	23.20	32	44.80	763
29,5x88,9 cm	RECT	12,3 ±0,5mm	4	1.05	22.00	40	42.00	901
39,4x118,9 cm	RECT	12,3 ±0,5mm	3	1.40	29.00	18	25.20	543

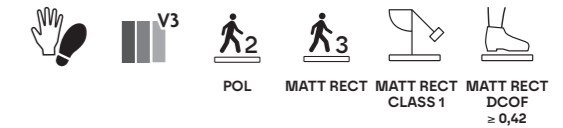

PEÇAS · PIECES			CAIXA · BOX			EUROPALETTE · EUROPALLET		
		±	PZ	M ²	KG	CX	M ²	KG
59,2x59,2 cm	MATT RECT	9,8 ±5%	4	1.40	33.00	32	44.80	1 077
	POL	9,8 ±5%	4	1.40	33.00	32	44.80	1 077
44,35x88,9 cm	MATT RECT	10,5 ±0,5mm	4	1.58	38.00	24	37.92	967
	POL	10,5 ±0,5mm	4	1.58	38.00	24	37.92	967
88,9x88,9 cm	MATT RECT	10,5 ±0,5mm	2	1.58	38.00	24	37.92	967
	POL	10,5 ±0,5mm	2	1.58	38.00	24	37.92	967
59,2x118,9 cm	MATT RECT	9,8 ±5%	2	1.40	33.00	30	42.00	1 011
	POL	9,8 ±5%	2	1.40	33.00	27	37.80	912

PEÇA · PIECE			PEÇA · PIECE			PEÇA · PIECE			PEÇA · PIECE			PEÇA · PIECE		
DG	MATT RECT	POL	RB	MATT RECT	POL	DG CF	MATT RECT	POL	DG CF SS	MATT RECT	POL	DG CF CANTO	MATT RECT	POL
29,5x59,2 cm	P18	P18	9,5x29,5 cm	P08	P08	29,5x59,2 cm	P157	P157	29,5x59,2 cm	P157	P157	29,5x59,2 cm	P207	P207
59,2x59,2 cm	P36	P36	8x44,35 cm	P16	P16									
44,35x88,9 cm	P96	P96	8x59,2 cm	P12	P12									
29,5x118,6 cm	P96	P96	8x88,9 cm	P28	P28									
59,2x118,6 cm	P167	P167	8x118,6 cm	P28	P28									

DG CF / DG CF Canto/DG CF SS: Peças produzidas sob encomenda. Altura do focinho: entre 3 cm e 10 cm. Indicar a altura pretendida no ato da encomenda.
 DG CF / DG CF Canto/DG CF SS: Pieces produced on order. Trim height: 3 to 10 cm. Specify desired height when placing a order.
 DG CF / DG CF Canto/DG CF SS: Pièces produites sur commande. Hauteur du nez de marche : entre 3 cm et 10 cm. Préciser la hauteur souhaitée lors de la commande.
 DG CF / DG CF Canto/DG CF SS: Piezas producidas por encargo. Altura del ángulo: entre 3 y 10 cm. Indicar la altura deseada al realizar el pedido.

DG CF Canto: Disponível em canto esquerdo e direito.
 DG CF Canto: Available in left and right corner.
 DG CF Canto: Disponible en angle gauche et droit.
 DG CF Canto: Canto izquierdo y derecho disponibles.

GRAPHIC VARIATION



São admissíveis ligeiras diferenças de tonalidade na mesma cor entre os diferentes formatos e tipologias de produto (revestimento cerâmico e grés porcelânico).
 Small differences in shades of the same colour are admissible between different product types (ceramic wall tiles and full body porcelain) and formats.
 De légères différences de tonalité d'une même couleur entre les différents formats et typologies de produits sont admissibles (faïence pâte blanche et grès cérame).
 Se admiten ligeras diferencias de tonalidad en el mismo color entre los diferentes formatos y tipos de producto (revestimiento cerámico y gres porcelánico).

Tendo em vista alcançar um efeito global mais real e harmonioso, são produzidas peças diferentes umas das outras com variações de desenho e/ou cores entre elas.
 For a more genuine and harmonious effect overall, different tiles with design and/or colour variations are produced.
 Afin d'obtenir un effet global plus réel et harmonieux, nos pièces sont différentes les unes des autres avec des variations de dessin et / ou de nuances entre elles.
 Para lograr un efecto global más real y armonioso, se producen piezas diferentes unas de otras con variaciones de diseño y/o color.



CALACATTA BIANCO MATE _ SHIFT SILVER CALACATTA _ OMNISTONE IRON

MARBLES

CALACATTA BIANCO



- 1 cor
colour
couleur
color
- 3 formatos
formats
formats
formatos
- 2 acabamentos
finishes
finitions
acabados

Veios cinza refinados remetem para tranquilidade e movimento, enriquecendo a vivência dos espaços.

Subtle grey veins inspire tranquillity and movement, and create livelier spaces.

Les veines grises raffinées renvoient à la tranquillité et au mouvement, rendant les expériences dans les espaces plus riches.

Las refinadas vetas grises transmiten tranquilidad y movimiento, y enriquecen la vivencia de los espacios.



RECT

39,4x118,6 cm (16"x47") 29,5x88,9 cm (12"x35") 29,5x59,2 cm (12"x23")

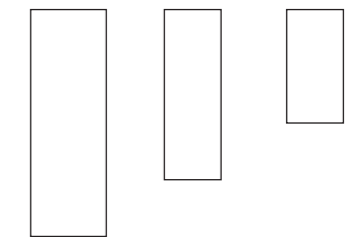

15

Até 15 desenhos
Up to 15 designs
Jusqu'à 15 dessins
Hasta 15 diseños

Calacatta Bianco

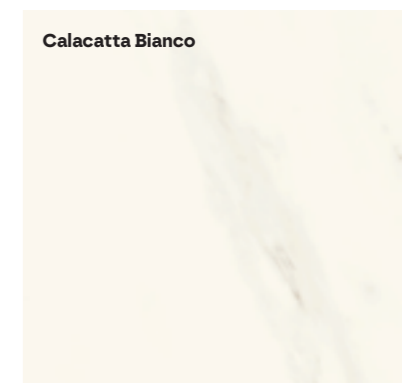

CALACATTA BIANCO



CALACATTA BIANCO BRILHO

3101211G41	29,5x59,2x0,90 cm	RECT	P75
3101G81G41	29,5x88,9x1,23 cm	RECT	P92
3101T91G41	39,4x118,6x1,23 cm	RECT	P99



CALACATTA BIANCO MATE

3101211G71	29,5x59,2x0,90 cm	RECT	P75
3101G81G71	29,5x88,9x1,23 cm	RECT	P92
3101T91G71	39,4x118,6x1,23 cm	RECT	P99



HERRINGBONE CALACATTA BIANCO (a)(b)(d)

3301U7F541	29x31x0,90 cm	P18 /peça_pieza
[1m² = 15 peças_piezas]		



SHIFT SILVER CALACATTA (a)(b)(d)(e)

3301U6F551	27x34x0,90 cm	P30 /peça_pieza
[1m² = 14 peças_piezas]		

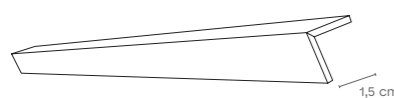

PERFIL		
1,5x39,4x1,23 cm	RECT	P28 /peça_pieza

PERFIL: produzido de acordo com quantidades mínimas de 10 peças.
 PERFIL: produced in minimum quantities of 10 pieces.
 PERFIL: produites selon des quantités minimales de 10 pièces.
 PERFIL: producidas en cantidades mínimas de 10 piezas.

(*) Dado o efeito deste produto, as peças devem ser aplicadas sempre no mesmo sentido, seguindo a orientação do tardo.
 (*) Given the effect of the product, tiles must always be laid out facing same direction, following the orientation of the back.
 (*) En raison de l'effet de ce produit, les carreaux doivent toujours être posés dans le même sens, en suivant l'orientation de sa face interne.
 (*) Dado el efecto de este producto, las piezas deben aplicarse siempre en el mismo sentido, siguiendo la orientación del dorso.

(**) Existem 3 peças diferentes, de acordo com o desenho do decorado, que devem ser aplicadas alternadamente, de modo a obter-se uma solução mais rica e variada.
 (**) There are 3 pieces, matching the design of the decorated tiles, which should be applied alternately in order to obtain a richer and more varied decoration.
 (**) Il y a 3 pièces différentes. Il convient des les appliquer de façon alternée pour obtenir une disposition plus riche et plus variée.
 (**) Existen 3 piezas diferentes, de acuerdo con el diseño del decorado, que deben aplicarse de forma alterna, con el fin de obtener una solución más rica y variada.

Para o assentamento de peças de grande formato, sugerimos a utilização de niveladores para ajudar a posicionar e nivelar a junta entre peças. Estes acessórios plásticos devem ser utilizados após a aplicação da cola.
 When laying large format tiles, use levelling spacers to ensure proper installing and levelling of tiles. Use the plastic spacers after the adhesive has been applied.
 Pour la pose de pièces de grand format, nous suggérons l'utilisation de croisillons autonivelants pour aider à positionner et à niveler le joint entre les pièces. Ces accessoires en plastique doivent être utilisés après l'application de la colle.
 Para la colocación de piezas de gran tamaño, sugerimos utilizar niveladores para ayudar a colocar y nivelar la junta entre piezas. Estos accesorios plásticos deben utilizarse una vez aplicada la cola.

CALACATTA BIANCO

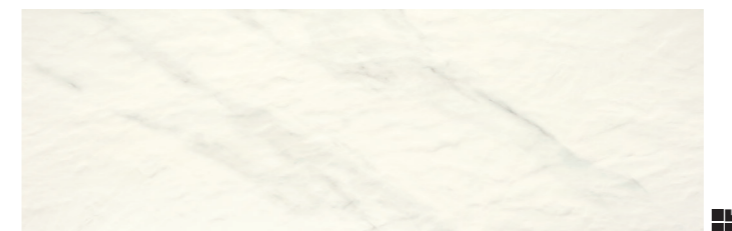

CALACATTA FEEL BIANCO MATE

3101G82G51	29,5x88,9x1,23 cm	RECT	P94
------------	-------------------	------	-----

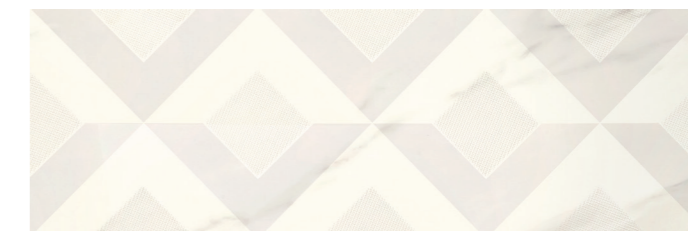

REFLEX BIANCO BRILHO (e)

3301G8F511	29,5x88,9x1,23 cm	RECT	P91 /peça_pieza
------------	-------------------	------	-----------------



CALACATTA SPIN MATE (**)

3101G82G61	29,5x88,9x1,23 cm	RECT	P94
------------	-------------------	------	-----



CALACATTA GIFT BIANCO BRILHO (c)

3101G82G41	29,5x88,9x1,23 cm	RECT	P94
------------	-------------------	------	-----



CALACATTA GIFT BIANCO BRILHO

CALACATTA BIANCO



CALACATTA CUBIC BIANCO BRILHO (*) (**)

3101213G91 29,5x59,2x0,90 cm RECT P80

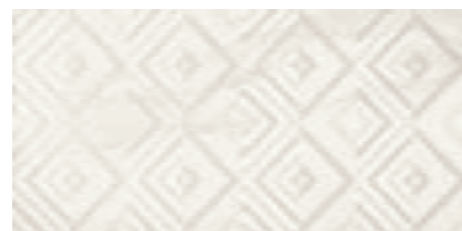

CALACATTA DIAMOND BRILHO (*)

3101213G41 29,5x59,2x0,90 cm RECT P80



CALACATTA WIND BIANCO MATE (*)

3101214G01 29,5x59,2x0,90 cm RECT P80

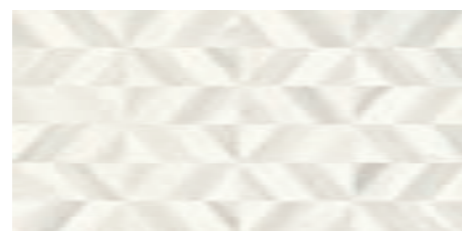

ZIGZAG MATE (*) (**)

3101213G51 29,5x59,2x0,90 cm RECT P80

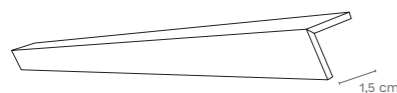

PERFIL		
1,5x29,5x0,90 cm	RECT	P20 /peça_pieza
1,5x59,2x0,90 cm	RECT	P32 /peça_pieza

PERFIL: produzido de acordo com quantidades mínimas de 10 peças.
 PERFIL: produced in minimum quantities of 10 pieces.
 PERFIL: produites selon des quantités minimales de 10 pièces.
 PERFIL: producidas en cantidades mínimas de 10 piezas.

(*) Dado o efeito deste produto, as peças devem ser aplicadas sempre no mesmo sentido, seguindo a orientação do tardo. (**) There are 3 pieces, matching the design of the decorated tiles, which should be applied alternately in order to obtain a richer and more varied decoration. (***) Il y a 3 pièces différentes. Il convient des les appliquer de façon alternée pour obtenir une disposition plus riche et plus variée. (***) Existen 3 piezas diferentes, de acuerdo con el diseño del decorado, que deben aplicarse de forma alterna, con el fin de obtener una solución más rica y variada.

Tendo em vista alcançar um efeito global mais real e harmonioso, são produzidas peças diferentes umas das outras com variações de desenho e/ou cores entre elas. For a more genuine and harmonious effect overall, different tiles with design and/or colour variations are produced. Afin d'obtenir un effet global plus réel et harmonieux, nos pièces sont différentes les unes des autres avec des variations de dessin et / ou de nuances entre elles. Para lograr un efecto global más real y armonioso, se producen piezas diferentes unas de otras con variaciones de diseño y/o color.

CALACATTA BIANCO



PEÇAS · PIECES			CAIXA · BOX			EUROPALETE · EUROPALLET		
		±	PZ	M²	KG	CX	M²	KG
29,5x59,2 cm	RECT	9,0 ±5%	8	1.40	23.20	32	44.80	763
29,5x88,9 cm	RECT	12,3 ±0,5mm	4	1.05	22.00	40	42.00	901
39,4x118,6 cm	RECT	12,3 ±0,5mm	3	1.40	29.00	18	25.20	543



REFLEX BIANCO BRILHO



WOOD

Nordik	334
Jinko	344
Deck	350
Montana	354
Forest	360
Deck Forest	363



WOOD

NORDIK

6 cores
colours
couleurs
colores

5 formatos
formats
formats
formatos

2 acabamentos
finishes
finitions
acabados



A nobreza das madeiras nórdicas reproduzidas num novo formato, para criar ambientes sofisticados.

The nobility of Nordic wood reproduced in a new format for creating sophisticated environments.

La noblesse des bois nordiques reproduite dans un nouveau format, pour créer des atmosphères sophistiquées.

La nobleza de las maderas nórdicas reproducida en un nuevo formato, para crear ambientes sofisticados.

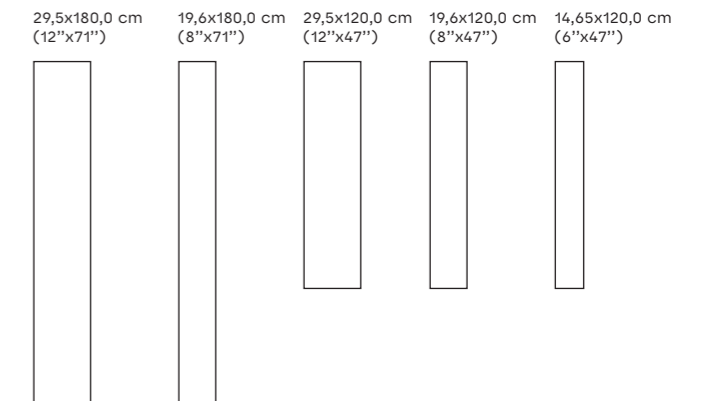

MATT RECT · ANTISLIP RECT

27

Até 27 desenhos
Up to 27 designs
Jusqu'à 27 dessins
Hasta 27 diseños



15

Até 15 desenhos
Up to 15 designs
Jusqu'à 15 dessins
Hasta 15 diseños

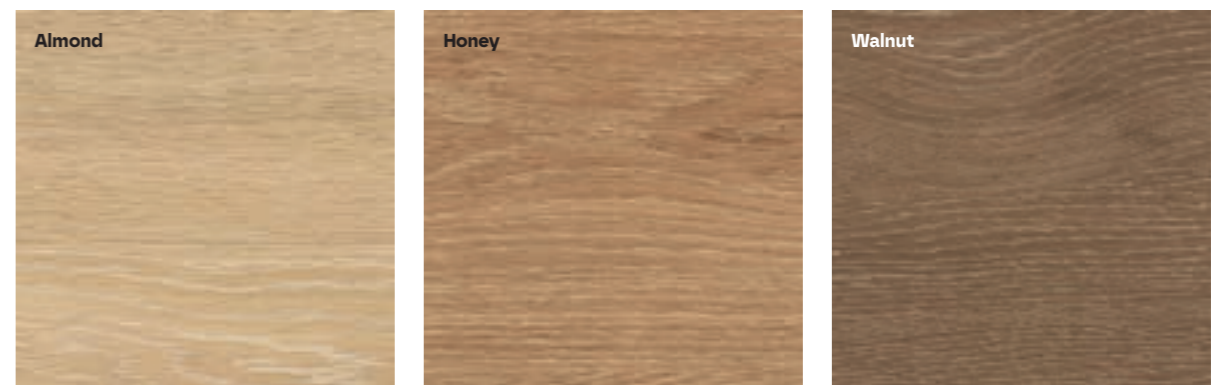

NORDIK



NORDIK ALMOND (*)

312BD54V71	14,65x120,0x1,05 cm	MATT RECT	P89
312BL84V71	19,6x120,0x1,05 cm	MATT RECT	P89
312DL84V71	19,6x120,0x1,05 cm	ANTISLIP RECT	P91
312BD64V71	29,5x120,0x1,05 cm	MATT RECT	P89
312BS84V71	19,6x180,0x1,12 cm	MATT RECT	P127
312BS74V71	29,5x180,0x1,12 cm	MATT RECT	P127



NORDIK HONEY (*)

312BD54V81	14,65x120,0x1,05 cm	MATT RECT	P89
312BL84V81	19,6x120,0x1,05 cm	MATT RECT	P89
312DL84V81	19,6x120,0x1,05 cm	ANTISLIP RECT	P91
312BD64V81	29,5x120,0x1,05 cm	MATT RECT	P89
312BS84V81	19,6x180,0x1,12 cm	MATT RECT	P127
312BS74V81	29,5x180,0x1,12 cm	MATT RECT	P127



NORDIK WALNUT (*)

312BD54V91	14,65x120,0x1,05 cm	MATT RECT	P89
312BL84V91	19,6x120,0x1,05 cm	MATT RECT	P89
312DL84V91	19,6x120,0x1,05 cm	ANTISLIP RECT	P91
312BD64V91	29,5x120,0x1,05 cm	MATT RECT	P89
312BS84V91	19,6x180,0x1,12 cm	MATT RECT	P127
312BS74V91	29,5x180,0x1,12 cm	MATT RECT	P127

(*) Dada a dimensão do produto e devido às tolerâncias de planaridade permitidas (de acordo com as normas internacionais), recomendamos a aplicação em paralelo e, no caso de aplicação em contrafiada, no máximo, a 1/4 da peça.

(*) Given the product's size and due to the planar tolerances allowed (in accordance with international standards), we recommend the parallel application and, if applied interrupting the joints, we recommend a maximum 1/4 application from the piece.

(*) Étant donné la dimension du produit et en raison des tolérances de planitude permises (conformément aux normes internationales), nous recommandons l'application en parallèle et, dans le cas d'application en contre-fil, au maximum d'1/4 de la pièce.

(*) Dada la dimensión del producto y debido a las tolerancias de planaridad permitidas (de acuerdo con las normas internacionales), recomendamos la aplicación en paralelo y, en el caso de aplicación en asiento, como máximo, a 1/4 de la pieza.

Para o assentamento de peças de grande formato, sugerimos a utilização de niveladores para ajudar a posicionar e nivelar a junta entre peças. Estes acessórios plásticos devem ser utilizados após a aplicação da cola.

When laying large format tiles, use levelling spacers to ensure proper installing and levelling of tiles. Use the plastic spacers after the adhesive has been applied.

Pour la pose de pièces de grand format, nous suggérons l'utilisation de croisillons autonivelants pour aider à positionner et à niveler le joint entre les pièces. Ces accessoires en plastique doivent être utilisés après l'application de la colle.

Para la colocación de piezas de gran tamaño, sugerimos utilizar niveladores para ayudar a colocar y nivelar la junta entre piezas. Estos accesorios plásticos deben utilizarse una vez aplicada la cola.

NORDIK



NORDIK WHITE (*)

312BD59U71	14,65x120,0x1,05 cm	MATT RECT	P89
312BL89U71	19,6x120,0x1,05 cm	MATT RECT	P89
312DL89U71	19,6x120,0x1,05 cm	ANTISLIP RECT	P91
312BD69U71	29,5x120,0x1,05 cm	MATT RECT	P89
312BS89U71	19,6x180,0x1,12 cm	MATT RECT	P127
312BS79U71	29,5x180,0x1,12 cm	MATT RECT	P127



NORDIK CHERRY (*)

312BD59U91	14,65x120,0x1,05 cm	MATT RECT	P89
312BL89U91	19,6x120,0x1,05 cm	MATT RECT	P89
312DL89U91	19,6x120,0x1,05 cm	ANTISLIP RECT	P91
312BD69U91	29,5x120,0x1,05 cm	MATT RECT	P89
312BS89U91	19,6x180,0x1,12 cm	MATT RECT	P127
312BS79U91	29,5x180,0x1,12 cm	MATT RECT	P127



NORDIK TAUPE (*)

312BD59U81	14,65x120,0x1,05 cm	MATT RECT	P89
312BL89U81	19,6x120,0x1,05 cm	MATT RECT	P89
312DL89U81	19,6x120,0x1,05 cm	ANTISLIP RECT	P91
312BD69U81	29,5x120,0x1,05 cm	MATT RECT	P89
312BS89U81	19,6x180,0x1,12 cm	MATT RECT	P127
312BS79U81	29,5x180,0x1,12 cm	MATT RECT	P127



IDEAL PARA PISO RADIANTE
IDEAL FOR UNDERFLOOR HEATING
IDÉAL SUR SOLS CHAUFFANTS
IDEAL PARA SUELO RADIANTE

Antislip: Produtos que minimizam o risco de deslizamento.
Antislip: Products that minimize the risk of slipping.
Antislip: Produits qui réduisent le risque de glissement.
Antislip: Productos que minimizan el riesgo de deslizamiento.



19,6x120,0 - 29,5x120,0 cm	MATT RECT	V3	4	class 1	A	R9	≥0,42	U4P3E3C2
19,6x120,0 cm	ANTISLIP RECT	V3	4	class 3	B	R11	≥0,42	U4P3E3C2
14,65x120,0 cm	MATT RECT	V3	4	class 1	A	R9	≥0,42	U4P2E3C2
19,6x180,0 - 29,5x180,0 cm	MATT RECT	V3	4	class 1	A	R9	≥0,42	-

NORDIK



CHEVRON LEFT NORDIK ALMOND

332BL87V71 19,6x120,0x1,05 cm MATT RECT P144



CHEVRON RIGHT NORDIK ALMOND

332BL88V01 19,6x120,0x1,05 cm MATT RECT P144



CHEVRON LEFT NORDIK HONEY

332BL87V91 19,6x120,0x1,05 cm MATT RECT P144



CHEVRON RIGHT NORDIK HONEY

332BL88V21 19,6x120,0x1,05 cm MATT RECT P144



CHEVRON LEFT NORDIK WALNUT

332BL87V81 19,6x120,0x1,05 cm MATT RECT P144



CHEVRON RIGHT NORDIK WALNUT

332BL88V11 19,6x120,0x1,05 cm MATT RECT P144



CHEVRON LEFT NORDIK WHITE

332BL834U1 19,6x120,0x1,05 cm MATT RECT P144



CHEVRON RIGHT NORDIK WHITE

332BD635U1 19,6x120,0x1,05 cm MATT RECT P144



CHEVRON LEFT NORDIK CHERRY

332BL845U1 19,6x120,0x1,05 cm MATT RECT P144



CHEVRON RIGHT NORDIK CHERRY

332BL844U1 19,6x120,0x1,05 cm MATT RECT P144



CHEVRON LEFT NORDIK TAUPE

332BL842U1 19,6x120,0x1,05 cm MATT RECT P144



CHEVRON RIGHT NORDIK TAUPE

332BL843U1 19,6x120,0x1,05 cm MATT RECT P144

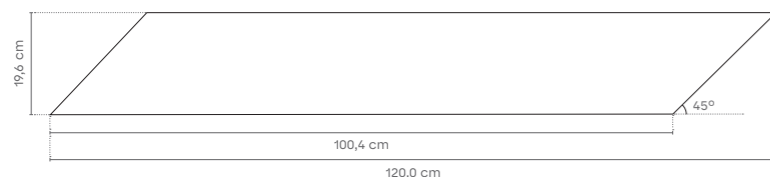

CHEVRON 19,5x120 cm
[1m² = 5 peças_pieces]

NORDIK



CHEVRON NORDIK WALNUT

NORDIK



LOKI ALMOND (a)(b)(f)

332BT1W911 19,5x19,5x1,05 cm **P15 /peça_piece**
[1m² = 26 peças_pieces]



LOKI WHITE (a)(b)(f)

332BT1X281 19,5x19,5x1,05 cm **P15 /peça_piece**
[1m² = 26 peças_pieces]



GRID ALMOND (a)(b)(f)

332B4AW941 35x43x1,05 cm **P10 /peça_piece**
[1m² = 12 peças_pieces]



GRID WHITE (a)(b)(f)

332B4AW991 35x43x1,05 cm **P10 /peça_piece**
[1m² = 12 peças_pieces]



LOKI HONEY (a)(b)(f)

332BT1W921 19,5x19,5x1,05 cm **P15 /peça_piece**
[1m² = 26 peças_pieces]

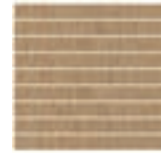

LOKI CHERRY (a)(b)(f)

332BT1X301 19,5x19,5x1,05 cm **P15 /peça_piece**
[1m² = 26 peças_pieces]



GRID HONEY (a)(b)(f)

332B4AW961 35x43x1,05 cm **P10 /peça_piece**
[1m² = 12 peças_pieces]



GRID CHERRY (a)(b)(f)

332B4AW951 35x43x1,05 cm **P10 /peça_piece**
[1m² = 12 peças_pieces]



LOKI WALNUT (a)(b)(f)

332BT1W931 19,5x19,5x1,05 cm **P15 /peça_piece**
[1m² = 26 peças_pieces]



LOKI TAUPE (a)(b)(f)

332BT1X291 19,5x19,5x1,05 cm **P15 /peça_piece**
[1m² = 26 peças_pieces]



GRID WALNUT (a)(b)(f)

332B4AW981 35x43x1,05 cm **P10 /peça_piece**
[1m² = 12 peças_pieces]



GRID TAUPE (a)(b)(f)

332B4AW971 35x43x1,05 cm **P10 /peça_piece**
[1m² = 12 peças_pieces]

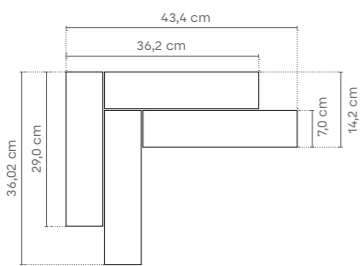

GRID 36x43 cm

[1m² = 12 peças_pieces]

NORDIK



GRID HONEY

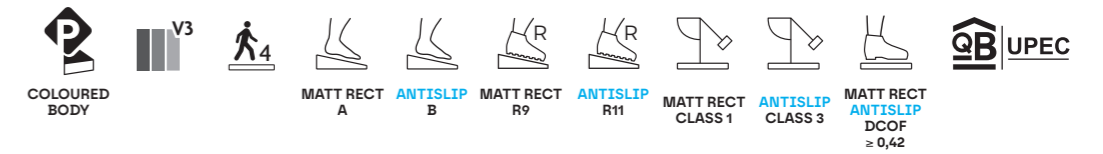

PEÇAS · PIECES			CAIXA · BOX			EUROPALETE · EUROPALLET		
		±	PZ	M²	KG	CX	M²	KG
14,65x120,0 cm	MATT RECT	10,5 ±5mm	8	1.41	34.70	16	22.56	576
19,6x120,0 cm	MATT RECT · ANTISLIP	10,5 ±5mm	6	1.41	33.00	22	31.02	747
	MATT RECT · CHEVRON	10,5 ±5mm	4	0.78	18.00	16	12.48	308
29,5x120,0 cm	MATT RECT	10,5 ±5mm	4	1.42	34.70	16	22.72	576
19,6x180,0 cm	MATT RECT	11,2 ±5mm	4	1.40	33.50	22	44.80	1.162
29,5x180,0 cm	MATT RECT	11,2 ±5mm	3	1.59	41.00	20	31.80	848

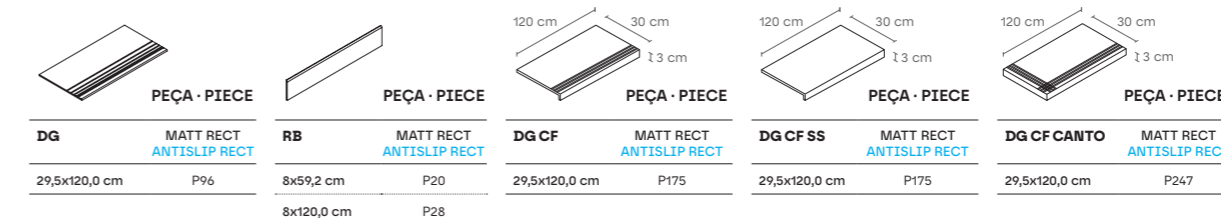

DG CF / DG CF Canto/DG CF SS: Peças produzidas sob encomenda. Altura do focinho: entre 3 cm e 10 cm. Indicar a altura pretendida no ato da encomenda.
 DG CF / DG CF Canto/DG CF SS: Pieces produced on order. Trim height: 3 to 10 cm. Specify desired height when placing a order.
 DG CF / DG CF Canto/DG CF SS: Pièces produites sur commande. Hauteur du nez de marche : entre 3 cm et 10 cm. Préciser la hauteur souhaitée lors de la commande.
 DG CF / DG CF Canto/DG CF SS: Piezas producidas por encargo. Altura del ángulo: entre 3 y 10 cm. Indicar la altura deseada al realizar el pedido.

DG CF Canto: Disponível em canto esquerdo e direito.
 DG CF Canto: Available in left and right corner.
 DG CF Canto: Disponible en angle gauche et droit.
 DG CF Canto: Canto izquierdo y derecho disponibles.





WOOD

JINKO

6 cores
colours
couleurs
colores

3 formatos
formats
formats
formatos

1 acabamento
finish
finition
acabado



Uma reinterpretação da madeira com um relevo suave que recria a textura natural.

Reinterpretation of wood with a smooth relief that recreates the natural texture.

Une réinterprétation du bois avec un doux relief qui recrée la texture naturelle.

Una reinterpretación de la madera con un relieve suave que recrea la textura natural.

29,5x120,0 cm
(12"x47")

19,6x120,0 cm
(8"x47")

14,65x120,0 cm
(6"x47")

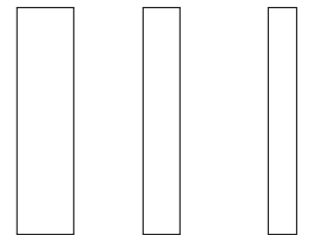

RECT

20

Até 20 desenhos
Up to 20 designs
Jusqu'à 20 dessins
Hasta 20 diseños

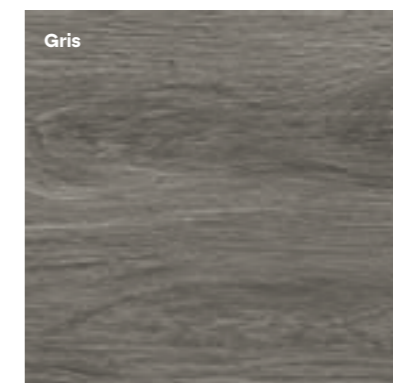
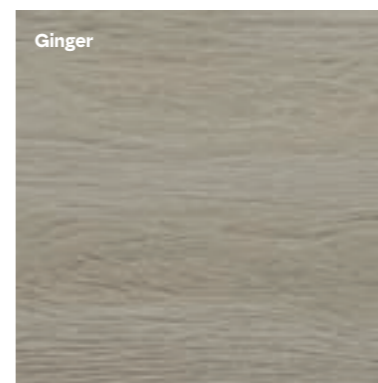
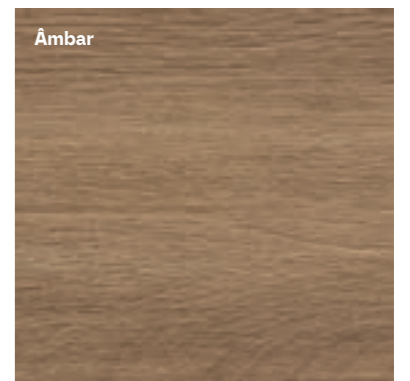
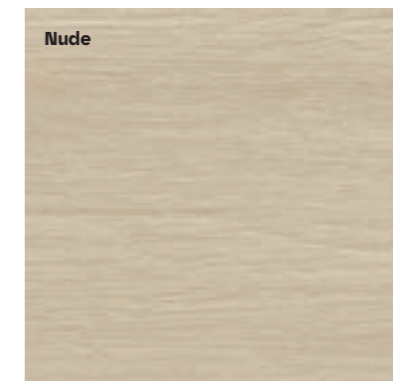
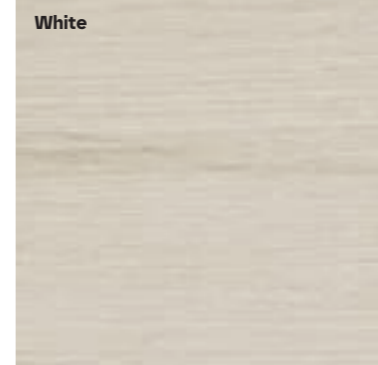

JINKO



JINKO GRIS

WOOD

346

revigres

JINKO GINGER _ JINKO ÁMBAR _ STRATUS 36 GLOBE FOG

WOOD

347

revigres

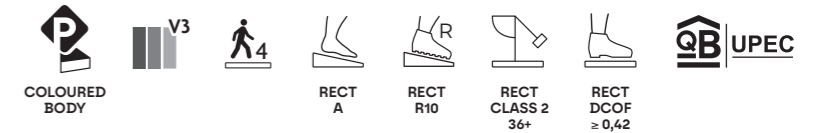

JINKO WHITE

3121D541T1	14,65x120,0x1,05 cm	RECT	P89
3121L841T1	19,6x120,0x1,05 cm	RECT	P89
3121D641T1	29,5x120,0x1,05 cm	RECT	P89



JINKO NUDE

3121D539T1	14,65x120,0x1,05 cm	RECT	P89
3121L839T1	19,6x120,0x1,05 cm	RECT	P89
3121D639T1	29,5x120,0x1,05 cm	RECT	P89



JINKO ÂMBAR

3121D536T1	14,65x120,0x1,05 cm	RECT	P89
3121L836T1	19,6x120,0x1,05 cm	RECT	P89
3121D636T1	29,5x120,0x1,05 cm	RECT	P89



JINKO GINGER

3121D537T1	14,65x120,0x1,05 cm	RECT	P89
3121L837T1	19,6x120,0x1,05 cm	RECT	P89
3121D637T1	29,5x120,0x1,05 cm	RECT	P89

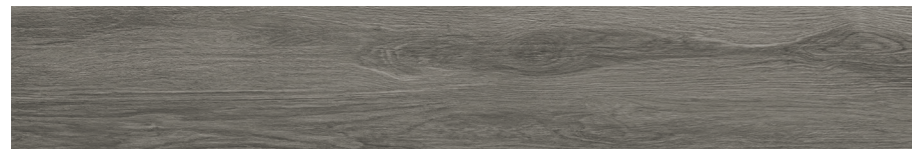

JINKO GRIS

3121D538T1	14,65x120,0x1,05 cm	RECT	P89
3121L838T1	19,6x120,0x1,05 cm	RECT	P89
3121D638T1	29,5x120,0x1,05 cm	RECT	P89



JINKO PEPPER

3121D540T1	14,65x120,0x1,05 cm	RECT	P89
3121L840T1	19,6x120,0x1,05 cm	RECT	P89
3121D640T1	29,5x120,0x1,05 cm	RECT	P89



IDEAL PARA PISO RADIANTE
IDEAL FOR UNDERFLOOR HEATING
IDÉAL SUR SOLS CHAUFFANTS
IDEAL PARA SUELO RADIANTE



19,6x120,0 · 29,5x120,0 cm	RECT	V3	4	class 2	A	R10	36+	≥0,42	U4P3E3C2
14,65x120,0 cm	RECT	V3	4	class 2	A	R10	36+	≥0,42	U4P2E3C2

PEÇAS · PIECES			CAIXA · BOX			EUROPALETE · EUROPALLET		
		±	PZ	M²	KG	CX	M²	KG
14,65x120,0 cm	RECT	10,5 ±5mm	8	1,41	34,70	16	22,56	576
19,6x120,0 cm	RECT	10,5 ±5mm	6	1,41	33,00	22	31,02	747
29,5x120,0 cm	RECT	10,5 ±5mm	4	1,42	34,70	16	22,72	576

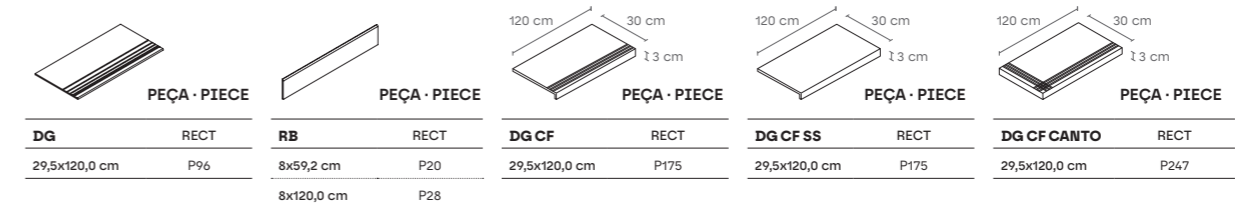

DG CF / DG CF Canto/DG CF SS: Peças produzidas sob encomenda. Altura do flocinho: entre 3 cm e 10 cm. Indicar a altura pretendida no ato da encomenda.
 DG CF / DG CF Canto/DG CF SS: Pieces produced on order. Trim height: 3 to 10 cm. Specify desired height when placing a order.
 DG CF / DG CF Canto/DG CF SS: Pièces produites sur commande. Hauteur du nez de marche : entre 3 cm et 10 cm. Préciser la hauteur souhaitée lors de la commande.
 DG CF / DG CF Canto/DG CF SS: Piezas producidas por encargo. Altura del ángulo: entre 3 y 10 cm. Indicar la altura deseada al realizar el pedido.

DG CF Canto: Disponível em canto esquerdo e direito.
 DG CF Canto: Available in left and right corner.
 DG CF Canto: Disponible en angle gauche et droit.
 DG CF Canto: Canto izquierdo y derecho disponibles.



CENTRO COMERCIAL NORTE SHOPPING — PORTO, PORTUGAL
 NORTE SHOPPING CENTER — PORTO, PORTUGAL

JINKO ÂMBAR

Dada a dimensão do produto e devido às tolerâncias de planaridade permitidas (de acordo com as normas internacionais), recomendamos a aplicação em paralelo e, no caso de aplicação em contrafiada, no máximo, a 1/4 da peça.

Given the product's size and due to the planar tolerances allowed (in accordance with international standards), we recommend the parallel application and, if applied interrupting the joints, we recommend a maximum 1/4 application from the piece.

Étant donné la dimension du produit et en raison des tolérances de planitude permises (conformément aux normes internationales), nous recommandons l'application en parallèle et, dans le cas d'application en contre-fil, au maximum d'1/4 de la pièce.

Dada la dimensión del producto y debido a las tolerancias de planaridad permitidas (de acuerdo con las normas internacionales), recomendamos la aplicación en paralelo y, en el caso de aplicación en asiento, como máximo, a 1/4 de la pieza.



DECK SUPERBRANCO

WOOD

DECK

5 cores / colours / couleurs / colores 1 formato / format / formato 1 acabamento / finish / finition / acabado



Deck cerâmico para espaços exteriores.

Ceramic deck for outdoor spaces.

Deck en céramique pour les espaces extérieurs.

Terraza cerámica para espacios exteriores.

14,65x120,0 cm
(6"x47")



RECT

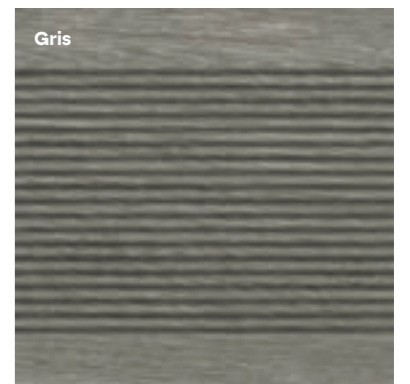
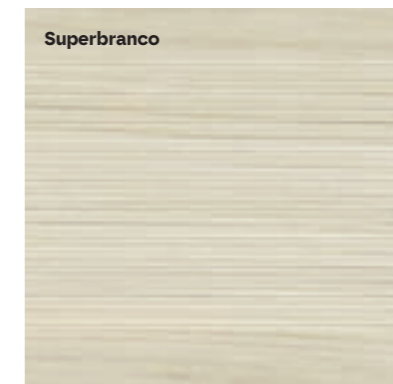

WOOD

350

revigres

WOOD

351

revigres

DECK



DECK SUPERBRANCO

3121D549S1 14,65x120,0x0,98 cm RECT P114



DECK GRIS

3121D5R751 14,65x120,0x0,98 cm RECT P104



DECK TECA

3121D58951 14,65x120,0x0,98 cm RECT P104

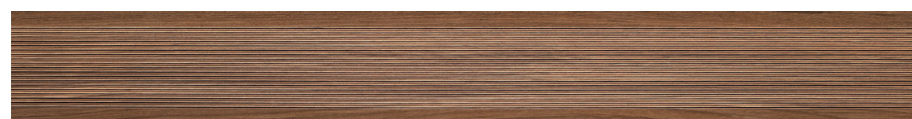

DECK IPÊ

3121D58941 14,65x120,0x0,98 cm RECT P114



DECK WENGÉ

3121D5R741 14,65x120,0x0,98 cm RECT P114

DECK: Produtos que minimizam o risco de deslizamento.
 DECK: Products that minimize the risk of slipping.
 DECK: Produits qui réduisent le risque de glissement.
 DECK: Productos que minimizan el riesgo de deslizamiento.

Dada a dimensão do produto e devido às tolerâncias de planaridade permitidas (de acordo com as normas internacionais), recomendamos a aplicação em paralelo e, no caso de aplicação em contrafiada, no máximo, a 1/4 da peça.

Given the product's size and due to the planar tolerances allowed (in accordance with international standards), we recommend the parallel application and, if applied interrupting the joints, we recommend a maximum 1/4 application from the piece.

Étant donné la dimension du produit et en raison des tolérances de planitude permises (conformément aux normes internationales), nous recommandons l'application en parallèle et, dans le cas d'application en contre-fil, au maximum d'1/4 de la pièce.

Dada la dimensión del producto y debido a las tolerancias de planaridad permitidas (de acuerdo con las normas internacionales), recomendamos la aplicación en paralelo y, en el caso de aplicación en asiento, como máximo, a 1/4 de la pieza.

Ao aplicar as peças na mesma direção, o ligeiro desalinhamento da parte lisa e/ou das riscas é uma característica intrínseca ao produto. Recomendamos a utilização de junta mínima de 3 mm.

When applying pieces in the same direction, the slight deviation of the flat part and /or stripes is a characteristic intrinsic to the product. We recommend the use of minimum joint of 3 mm.

Lors de la pose des pièces dans le même sens, le léger décalage de l'alignement de la partie lisse et /ou des rayures est une caractéristique intrinsèque du produit. Nous recommandons l'utilisation d'un joint d'environ 3 mm.

Al aplicar las piezas en la misma dirección, la ligera desalineación de la parte lisa y/o de las rayas es una característica intrínseca al producto. Le recomendamos el uso de una junta mínima de 3 mm.



14,65x120,0 cm RECT V2 5 class 3 C R11 36+ ≥0,42

DECK

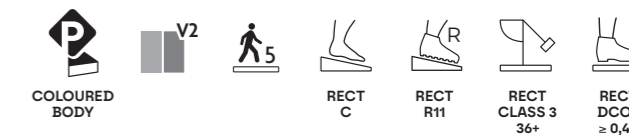

PEÇAS · PIECES	CAIXA · BOX			EUROPALETE · EUROPALLET			
		PZ	M²	KG	CX	M²	KG
14,65x120,0 cm RECT	9,8 ±5%	8	1,41	34,70	18	25,38	646

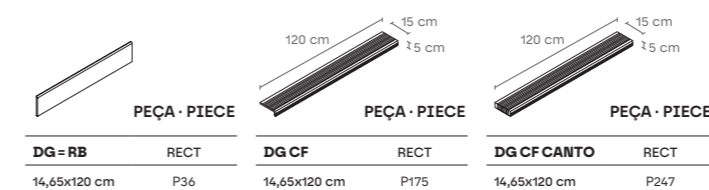

DG CF / DG CF Canto: Peças produzidas sob encomenda.
 DG CF / DG CF Canto: Pieces produced on order.
 DG CF / DG CF Canto: Pièces produites sur commande.
 DG CF / DG CF Canto: Piezas producidas por encargo.

DG CF Canto: Disponível em canto esquerdo e direito.
 DG CF Canto: Available in left and right corner.
 DG CF Canto: Disponible en angle gauche et droit.
 DG CF Canto: Canto izquierdo y derecho disponibles.



CENTRO COMERCIAL VASCO DA GAMA — LISBOA, PORTUGAL
 VASCO DA GAMA SHOPPING CENTER — LISBON, PORTUGAL

DECK WENGÉ



WOOD

MONTANA

5 cores
colours
couleurs
colores

1 formato
format
format
formato

1 acabamento
finish
finition
acabado



Uma variação gráfica muito rica e tons naturais recriam os pormenores da madeira, remetendo para conforto e tranquilidade.

Rich graphic variation and natural shades recreate the details of wood, inspiring comfort and tranquillity.

Une variation graphique très riche et des teintes naturelles recréent les détails du bois, renvoyant au confort et à la tranquillité.

Una variación gráfica muy rica y tonos naturales recrean los detalles de la madera y transmiten confort y tranquilidad.

20x90 cm
(8"x35")



MATT NAT

19

Até 19 desenhos
Up to 19 designs
Jusqu'à 19 dessins
Hasta 19 diseños

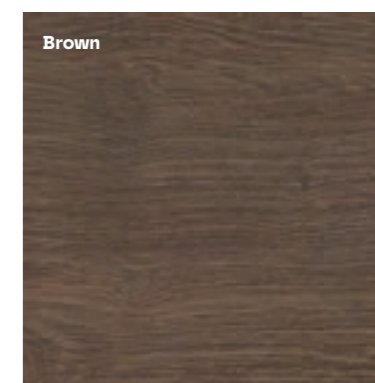
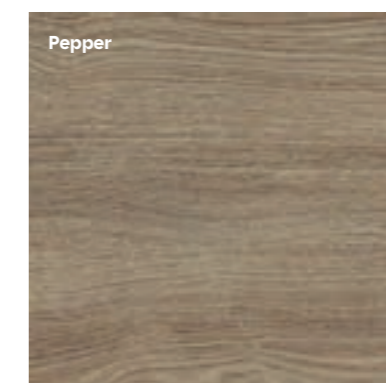
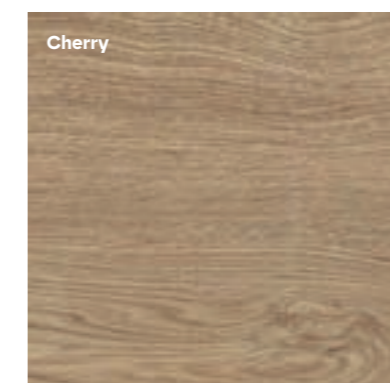
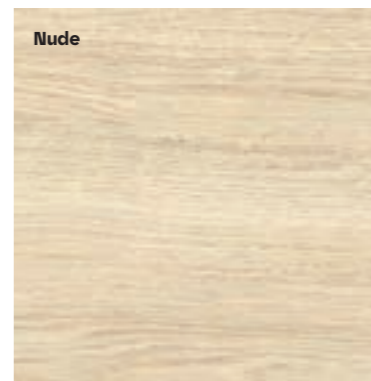

MONTANA



MONTANA NUDE

312AU0V141 20x90x1,05 cm MATT NAT P77



MONTANA BEGE

312AU0V111 20x90x1,05 cm MATT NAT P77



MONTANA CHERRY

312AU0V131 20x90x1,05 cm MATT NAT P77



MONTANA PEPPER

312AU0V151 20x90x1,05 cm MATT NAT P77

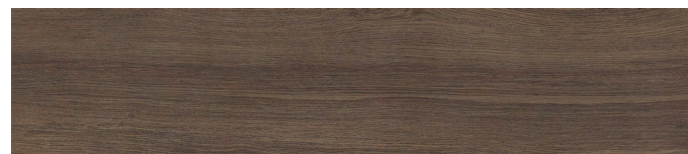

MONTANA BROWN

312AU0V121 20x90x1,05 cm MATT NAT P77



MONTANA PEPPER



IDEAL PARA PISO RADIANTE
 IDEAL FOR UNDERFLOOR HEATING
 IDÉAL SUR SOLS CHAUFFANTS
 IDEAL PARA SUELO RADIANTE

Dada a dimensão do produto e devido às tolerâncias de planaridade permitidas (de acordo com as normas internacionais), recomendamos a aplicação em espinha e, no caso de aplicação em contrafiada, no máximo, a 1/4 da peça.

Given the product's size and due to the flatness tolerance (in accordance with international standards), we recommend laying in herringbone pattern and it is advisable to overlap no more than 1/4 of the adjoining piece when laying with offset joints.

Étant donné la dimension du produit et en raison des tolérances de planitude permises (conformément aux normes internationales), nous recommandons l'application en chevron et, dans le cas d'application en contre-fil, au maximum d'1/4 de la pièce.

Dada la dimensión del producto y debido a las tolerancias de planaridad permitidas (de acuerdo con las normas internacionales), recomendamos la aplicación en espiga y, en el caso de aplicación en asiento, como máximo, a 1/4 de la pieza.



20x90 cm	MATT RECT	V3	3	class 2	A	R10	36+	≥0,42	U3P3E3C2	
20x90 cm	Montana Brown	MATT RECT	V3	3	class 2	A	R10	36+	≥0,42	U2P3E3C2

MONTANA



MONTANA NUDE _ MONTANA BEGE _ ELEMENTS FOG _ DI ALBA STONE GREY

DIVERSAS FORMAS DE APLICAÇÃO:
 DIFFERENT WAYS OF APPLICATION:
 DIFFÉRENTS MODES D'APPLICATION:
 DIVERSAS FORMAS DE APLICACIÓN:

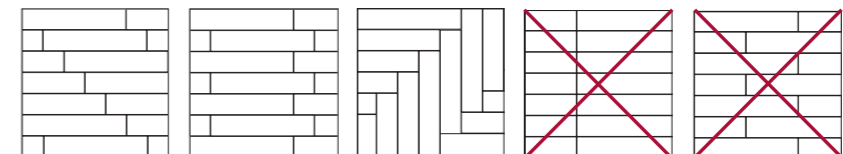

MONTANA



CHEVRON LEFT MONTANA NUDE

332AU0V411 20x90x1,05 cm MATT NAT P110



CHEVRON RIGHT MONTANA NUDE

332AU0V421 20x90x1,05 cm MATT NAT P110



CHEVRON LEFT MONTANA BEGE

332AU0V351 20x90x1,05 cm MATT NAT P110



CHEVRON RIGHT MONTANA BEGE

332AU0V361 20x90x1,05 cm MATT NAT P110



CHEVRON LEFT MONTANA CHERRY

332AU0V391 20x90x1,05 cm MATT NAT P110



CHEVRON RIGHT MONTANA CHERRY

332AU0V401 20x90x1,05 cm MATT NAT P110



CHEVRON LEFT MONTANA PEPPER

332AU0V431 20x90x1,05 cm MATT NAT P110



CHEVRON RIGHT MONTANA PEPPER

332AU0V441 20x90x1,05 cm MATT NAT P110

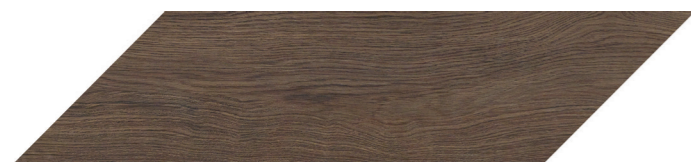

CHEVRON LEFT MONTANA BROWN

332AU0V371 20x90x1,05 cm MATT NAT P110

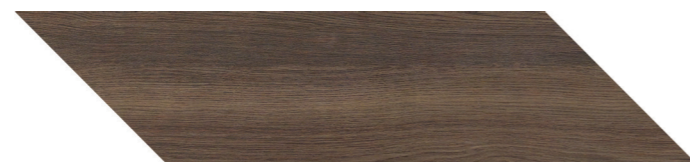

CHEVRON RIGHT MONTANA BROWN

332AU0V381 20x90x1,05 cm MATT NAT P110

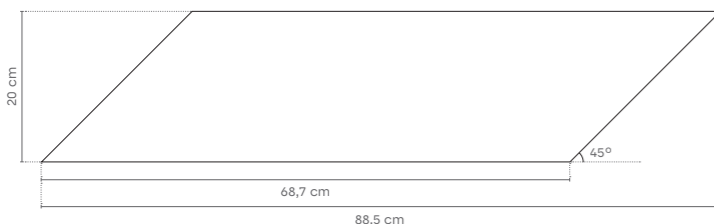

CHEVRON 20x90 cm
[1m² = 7 peças_pieces]

CHEVRON: Acabamento normal nas arestas maiores e acabamento retificado nas arestas menores.
CHEVRON: Standard finish of long edges and rectified short edges.
CHEVRON: Finition normale sur les arêtes plus grandes et finition rectifiée sur les arêtes mineures.
CHEVRON: Acabado normal en las aristas mayores y acabado rectificado en las aristas menores.

MONTANA

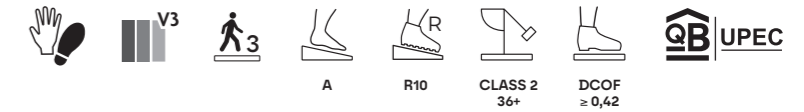

PEÇAS · PIECES			CAIXA · BOX			EUROPALETE · EUROPALLET		
		±	PZ	M ²	KG	CX	M ²	KG
20x90 cm	MATT NAT	10,5 ±0,5mm	6	1,08	26,20	36	38,88	964
20x90 cm	MATT NAT · CHEVRON	10,5 ±0,5mm	6	0,82	21,90	36	29,52	809

PEÇA · PIECE		PEÇA · PIECE	
DG	MATT NAT	RB	MATT NAT
20x90 cm	P18	9,5x90 cm	P12



CHEVRON MONTANA BROWN



WOOD

FOREST_DECK FOREST

6 cores colours couleurs colores 1 formato format formato 2 acabamentos finishes finitions acabados



FOREST



DECK FOREST

Os veios das madeiras naturais combinados com a durabilidade da cerâmica.

The vein patterns of natural wood combined with the longevity of ceramics.

Le grain caractéristique des bois naturels associé à la durabilité de la céramique.

Las vetas de las maderas naturales combinadas con la durabilidad de la cerámica.

15x75 cm
(6"x30")



NAT · ANTISLIP

19

Até 19 desenhos
Up to 19 designs
Jusqu'à 19 dessins
Hasta 19 diseños

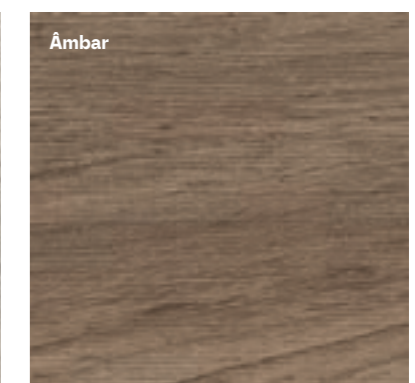
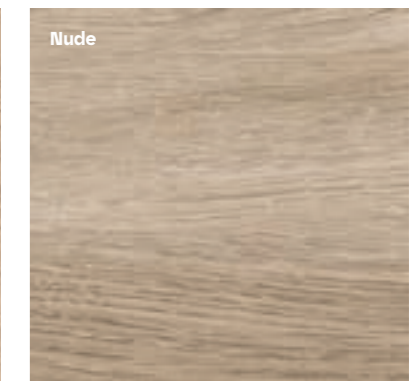
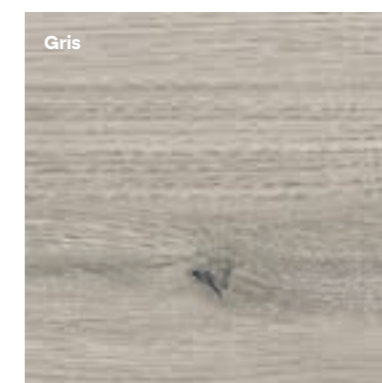
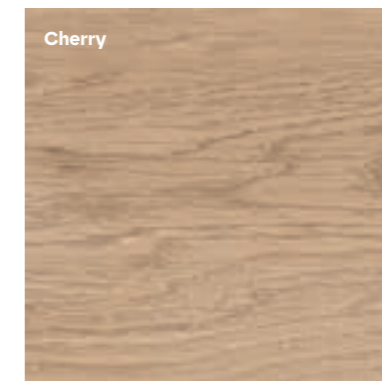
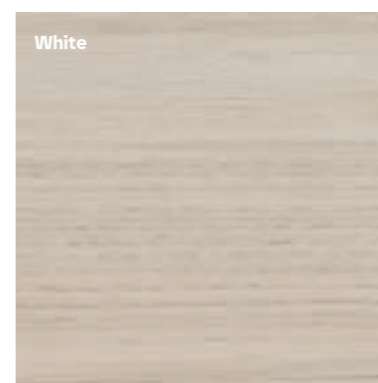
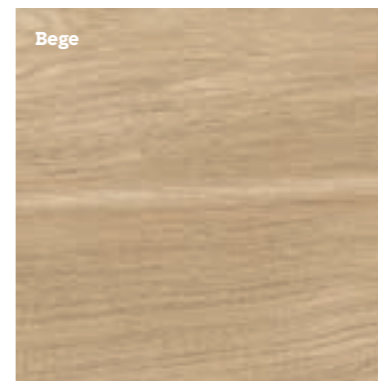

FOREST _ ANTISLIP FOREST



FOREST BEGE

3110O72T91	15x75x0,85 cm	NAT	P70
------------	---------------	-----	-----

ANTISLIP FOREST BEGE

3110O73T41	15x75x0,85 cm	NAT	P73
------------	---------------	-----	-----



FOREST CHERRY

3110O73T01	15x75x0,85 cm	NAT	P70
------------	---------------	-----	-----

ANTISLIP FOREST CHERRY

3110O73T51	15x75x0,85 cm	NAT	P73
------------	---------------	-----	-----



FOREST NUDE

3110O73T21	15x75x0,85 cm	NAT	P70
------------	---------------	-----	-----

ANTISLIP FOREST NUDE

3110O73T71	15x75x0,85 cm	NAT	P73
------------	---------------	-----	-----



FOREST WHITE

3110O73T31	15x75x0,85 cm	NAT	P70
------------	---------------	-----	-----

ANTISLIP FOREST WHITE

3110O73T81	15x75x0,85 cm	NAT	P73
------------	---------------	-----	-----

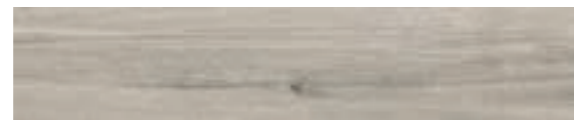

FOREST GRIS

3110O73T11	15x75x0,85 cm	NAT	P70
------------	---------------	-----	-----

ANTISLIP FOREST GRIS

3110O73T61	15x75x0,85 cm	NAT	P73
------------	---------------	-----	-----



FOREST ÂMBAR

3110O749T1	15x75x0,85 cm	NAT	P70
------------	---------------	-----	-----

ANTISLIP FOREST ÂMBAR

3110O750T1	15x75x0,85 cm	NAT	P73
------------	---------------	-----	-----



ANTISLIP FOREST BEGE

IDEAL PARA PISO RADIANTE
 IDEAL FOR UNDERFLOOR HEATING
 IDÉAL SUR SOLS CHAUFFANTS
 IDEAL PARA SUELO RADIANTE

Antislip: Produtos que minimizam o risco de deslizamento.
 Antislip: Products that minimize the risk of slipping.
 Antislip: Produits qui réduisent le risque de glissement.
 Antislip: Productos que minimizan el riesgo de deslizamiento.

Dada a dimensão do produto e devido às tolerâncias de planaridade permitidas (de acordo com as normas internacionais), recomendamos a aplicação em espinha e, no caso de aplicação em contrafiada, no máximo, a 1/4 da peça.

Given the product's size and due to the flatness tolerance (in accordance with international standards), we recommend laying in herringbone pattern and it is advisable to overlap no more than 1/4 of the adjoining piece when laying with offset joints.

Étant donnée la dimension du produit et en raison des tolérances de planitude permises (conformément aux normes internationales), nous recommandons l'application en chevron et, dans le cas d'application en contre-fil, au maximum d'1/4 de la pièce.

Dada la dimensión del producto y debido a las tolerancias de planaridad permitidas (de acuerdo con las normas internacionales), recomendamos la aplicación en espiga y, en el caso de aplicación en asiento, como máximo, a 1/4 de la pieza.



15x75 cm	NAT	V3	3	class 1	A	R9
15x75 cm	ANTISLIP	V3	3	class 3	C	R11

FOREST _ ANTISLIP FOREST



NEUTRAL MARFIM _ FOREST BEGE _ ANTISLIP FOREST BEGE

DIVERSAS FORMAS DE APLICAÇÃO:
 DIFFERENT WAYS OF APPLICATION:
 DIFFÉRENTS MODES D'APPLICATION:
 DIVERSAS FORMAS DE APLICACIÓN:

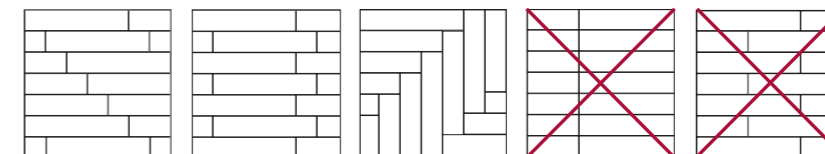

DECK FOREST



DECK FOREST BEGE

3110076U51 15x75x0,85 cm NAT P73



DECK FOREST NUDE

3110076U61 15x75x0,85 cm NAT P73



DECK FOREST GRIS

3110076U71 15x75x0,85 cm NAT P73



DECK FOREST ÂMBAR

3110076U81 15x75x0,85 cm NAT P73

FOREST _ ANTISLIP FOREST _ DECK FOREST

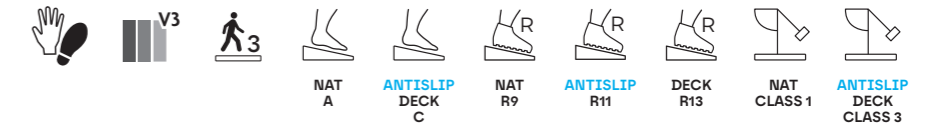

PEÇAS · PIECES			CAIXA · BOX			EUROPALETE · EUROPALLET		
		±	PZ	M ²	KG	CX	M ²	KG
15x75 cm	NAT	8,5 ±0,5%	8	0,90	17,50	64	57,60	1 141

PEÇA · PIECE		PEÇA · PIECE	
DG	NAT ANTISLIP	RB FOREST - ANTISLIP FOREST	NAT ANTISLIP
15x75 cm	P12	7,5x75 cm	P07



DECK: Produtos que minimizam o risco de deslizamento.
 DECK: Products that minimize the risk of slipping.
 DECK: Produits qui réduisent le risque de glissement.
 DECK: Productos que minimizan el riesgo de deslizamiento.

Dada a dimensão do produto e devido às tolerâncias de planaridade permitidas (de acordo com as normas internacionais), recomendamos a aplicação em paralelo e, no caso de aplicação em contrafiada, no máximo, a 1/4 da peça.
 Given the product's size and due to the planar tolerances allowed (in accordance with international standards), we recommend the parallel application and, if applied interrupting the joints, we recommend a maximum 1/4 application from the piece.
 Étant donnée la dimension du produit et en raison des tolérances de planitude permises (conformément aux normes internationales), nous recommandons l'application en parallèle et, dans le cas d'application en contre-fil, au maximum d'1/4 de la pièce.
 Dada la dimensión del producto y debido a las tolerancias de planaridad permitidas (de acuerdo con las normas internacionales), recomendamos la aplicación en paralelo y, en el caso de aplicación en asiento, como máximo, a 1/4 de la pieza.

Ao aplicar as peças na mesma direção, o ligeiro desalinhamento da parte lisa e/ou das riscas é uma característica intrínseca ao produto. Recomendamos a utilização de junta mínima de 3 mm.
 When applying pieces in the same direction, the slight deviation of the flat part and /or stripes is a characteristic intrinsic to the product. We recommend the use of minimum joint of 3 mm.
 Lors de la pose des pièces dans le même sens, le léger décalage de l'alignement de la partie lisse et /ou des rayures est une caractéristique intrinsèque du produit. Nous recommandons l'utilisation d'un joint d'environ 3 mm.
 Al aplicar las piezas en la misma dirección, la ligera desalineación de la parte lisa y/o de las rayas es una característica intrínseca al producto. Le recomendamos el uso de una junta mínima de 3 mm.



15x75 cm NAT V3 3 class 3 C R13

DECK FOREST NUDE



LOCUS GRIS _ HEXA SHADOW GRIS

DECORS & BARRAS

DECORADOS E BARRAS · DECORS ET BANDES · DECORADOS Y BARRAS

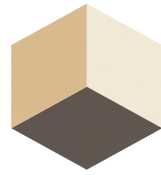

TRIO CHILL OUT (a)(f)
20x22x0,85 cm SOFT **P11 /peça_pieza**
Cromática: Bege + Superbranco + Astral

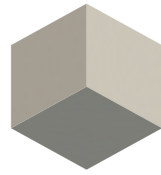

TRIO WINTER (a)(f)
20x22x0,85 cm SOFT **P11 /peça_pieza**
Cromática: Titanium + Alloy + Grafite



MULTI OMNI ICE (a)(f)
29,5x29,5x0,98 cm MATT RECT **P22 /peça_pieza**
[1m² = 11 peças_pieces]



MULTI OMNISTONE ICE (a)(f)
29,5x29,5x0,98 cm MATT RECT **P22 /peça_pieza**
[1m² = 11 peças_pieces]

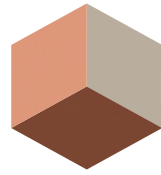

TRIO BLOOM (a)(f)
20x22x0,85 cm SOFT **P12 /peça_pieza**
Cromática: Coral + Quartz + Terracotta



TRIO SPRING SUN (a)(f)
20x22x0,85 cm SOFT **P11 /peça_pieza**
Cromática: Ocre + Bone + Oliva



MULTI OMNI BONE (a)(f)
29,5x29,5x0,98 cm MATT RECT **P22 /peça_pieza**
[1m² = 11 peças_pieces]



MULTI OMNISTONE BONE (a)(f)
29,5x29,5x0,98 cm MATT RECT **P22 /peça_pieza**
[1m² = 11 peças_pieces]



TRIO AUTUMN (a)(f)
20x22x0,85 cm SOFT **P12 /peça_pieza**
Cromática: Palm + Bone + Brick

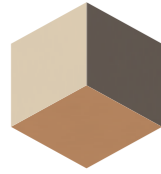

TRIO SAFARI (a)(f)
20x22x0,85 cm SOFT **P11 /peça_pieza**
Cromática: Bone + Astral + Toffee



MULTI OMNI PLATINA (a)(f)
29,5x29,5x0,98 cm MATT RECT **P22 /peça_pieza**
[1m² = 11 peças_pieces]



MULTI OMNISTONE PLATINA (a)(f)
29,5x29,5x0,98 cm MATT RECT **P22 /peça_pieza**
[1m² = 11 peças_pieces]



TRIO SUMMER NIGHT (a)(f)
20x22x0,85 cm SOFT **P14 /peça_pieza**
Cromática: Opala + Platina + Indigo



TRIO FRESHY (a)(f)
20x22x0,85 cm SOFT **P12 /peça_pieza**
Cromática: Bone + Pistachio + Lagoon



MULTI OMNI ROPE (a)(f)
29,5x29,5x0,98 cm MATT RECT **P22 /peça_pieza**
[1m² = 11 peças_pieces]

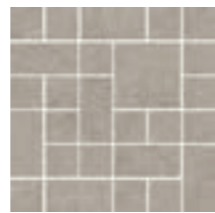

MULTI OMNISTONE ROPE (a)(f)
29,5x29,5x0,98 cm MATT RECT **P22 /peça_pieza**
[1m² = 11 peças_pieces]

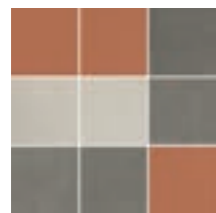

STRATUS 9 LOCUS MIX BRICK (a)(f)
Bases: Locus Alloy + Locus Gris + Cromática Brick
29,5x29,5x0,85 cm SILK **P19 /peça_pieza**
[1m² = 11 peças_pieces]



STRATUS 9 LOCUS MIX COBALTO (a)(f)
Bases: Locus Alloy + Locus Smog + Cromática Cobalto
29,5x29,5x0,85 cm SILK **P19 /peça_pieza**
[1m² = 11 peças_pieces]

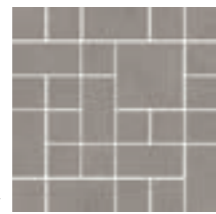

MULTI OMNI IRON (a)(f)
29,5x29,5x0,98 cm MATT RECT **P22 /peça_pieza**
[1m² = 11 peças_pieces]

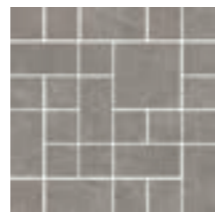

MULTI OMNISTONE IRON (a)(f)
29,5x29,5x0,98 cm MATT RECT **P22 /peça_pieza**
[1m² = 11 peças_pieces]

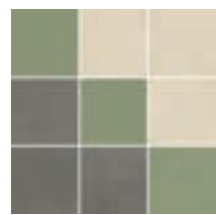

STRATUS 9 LOCUS MIX OLIVA (a)(f)
Bases: Locus Bone + Locus Gris + Cromática Oliva
29,5x29,5x0,85 cm SILK **P19 /peça_pieza**
[1m² = 11 peças_pieces]



STRATUS 9 LOCUS MIX OCRE (a)(f)
Bases: Locus Bone + Locus Gris + Cromática Ocre
29,5x29,5x0,85 cm SILK **P19 /peça_pieza**
[1m² = 11 peças_pieces]

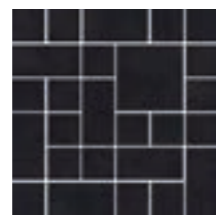

MULTI OMNI JET (a)(f)
29,5x29,5x0,98 cm MATT RECT **P22 /peça_pieza**
[1m² = 11 peças_pieces]

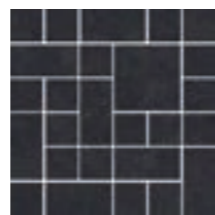

MULTI OMNISTONE JET (a)(f)
29,5x29,5x0,98 cm MATT RECT **P22 /peça_pieza**
[1m² = 11 peças_pieces]

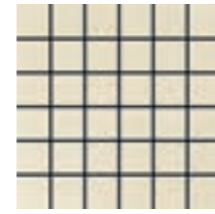

STRATUS 36 FLINT MARFIM (a)(f)
29,5x29,5x0,85 cm RECT **P19 /peça_pieza**
[1m² = 11 peças_pieces]



STEP GOLD (a)
29,5x29,5x0,85 cm **P96 /peça_pieza**
[1m² = 11 peças_pieces]



HEXA FLOW BONE (b)(f)
16,5x19x0,85cm SOFT GRIP **P15 /peça_pieza**
[1m² = 41 peças_pieces]



HEXA FLOW SMOG (b)(f)
16,5x19x0,85cm SOFT GRIP **P15 /peça_pieza**
[1m² = 41 peças_pieces]

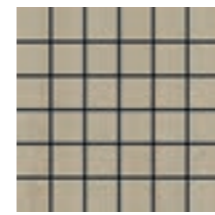

STRATUS 36 FLINT PLATINA (a)(f)
29,5x29,5x0,85 cm RECT **P19 /peça_pieza**
[1m² = 11 peças_pieces]



STEP COPPER (a)
29,5x29,5x0,85 cm **P29 /peça_pieza**
[1m² = 11 peças_pieces]

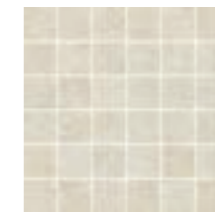

STRATUS 36 CITYZEN OFFWHITE (a)(f)
29,5x29,5x0,85 cm MATT RECT **P19 /peça_pieza**
[1m² = 11 peças_pieces]



HEXA SHADOW GRIS (b)(f)
16,5x19x0,85cm SOFT GRIP **P14 /peça_pieza**
[1m² = 41 peças_pieces]



STRATUS 36 FLINT ARG PRATA (a)(f)
29,5x29,5x0,85 cm RECT **P19 /peça_pieza**
[1m² = 11 peças_pieces]



STEP SILVER (a)
29,5x29,5x0,85 cm **P96 /peça_pieza**
[1m² = 11 peças_pieces]



STRATUS 36 CITYZEN BONE (a)(f)
29,5x29,5x0,85 cm MATT RECT **P19 /peça_pieza**
[1m² = 11 peças_pieces]



STRATUS 36 ELEMENTS MIST (a)(f)
29,5x29,5x0,85 cm SOFT **P19 /peça_pieza**
[1m² = 11 peças_pieces]

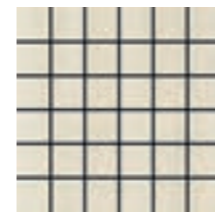

STRATUS 36 FLINT ICE (a)(f)
29,5x29,5x0,85 cm RECT **P19 /peça_pieza**
[1m² = 11 peças_pieces]

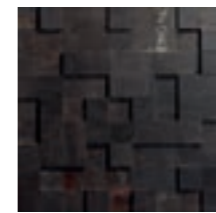

STEP IRON (a)
29,5x29,5x0,85 cm **P29 /peça_pieza**
[1m² = 11 peças_pieces]



STRATUS 36 CITYZEN FOG (a)(f)
29,5x29,5x0,85 cm MATT RECT **P19 /peça_pieza**
[1m² = 11 peças_pieces]



STRATUS 36 ELEMENTS SMOKE (a)(f)
29,5x29,5x0,85 cm SOFT **P19 /peça_pieza**
[1m² = 11 peças_pieces]

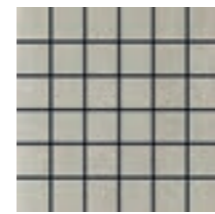

STRATUS 36 FLINT GLACIAR (a)(f)
29,5x29,5x0,85 cm RECT **P19 /peça_pieza**
[1m² = 11 peças_pieces]



STRATUS 36 FLINT GRIS (a)(f)
29,5x29,5x0,85 cm RECT **P19 /peça_pieza**
[1m² = 11 peças_pieces]

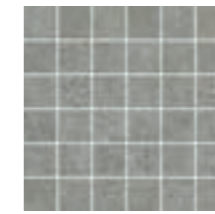

STRATUS 36 CITYZEN GRIS (a)(f)
29,5x29,5x0,85 cm MATT RECT **P19 /peça_pieza**
[1m² = 11 peças_pieces]

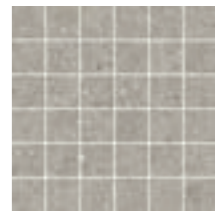

STRATUS 36 ELEMENTS FOG (a)(f)
29,5x29,5x0,85 cm SOFT **P19 /peça_pieza**
[1m² = 11 peças_pieces]



STRATUS 36 FLINT FOG (a)(f)
29,5x29,5x0,85 cm RECT **P19 /peça_pieza**
[1m² = 11 peças_pieces]

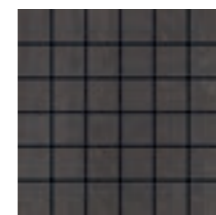

STRATUS 36 FLINT PRETO (a)(f)
29,5x29,5x0,85 cm RECT **P19 /peça_pieza**
[1m² = 11 peças_pieces]

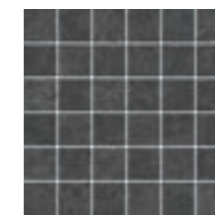

STRATUS 36 CITYZEN CARBON (a)(f)
29,5x29,5x0,85 cm MATT RECT **P19 /peça_pieza**
[1m² = 11 peças_pieces]

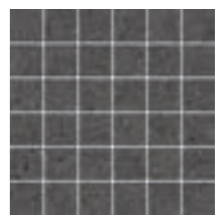

STRATUS 36 ELEMENTS CARBON (a)(f)
29,5x29,5x0,85 cm SOFT **P19 /peça_pieza**
[1m² = 11 peças_pieces]



STRATUS 36 URBAN OFFWHITE (a)(f)
29,5x29,5x0,85 cm **P19 /peça_pieza**
[1m² = 11 peças_pieces]



STRATUS 36 LAVASTONE BONE (a)(f)
29,5x29,5x0,85 cm **ANTISLIP RECT P19 /peça_pieza**
[1m² = 11 peças_pieces]

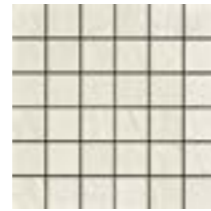

STRATUS 36 XISTO SUPERBRANCO (a)(f)
29,5x29,5x0,85 cm **P19 /peça_pieza**
[1m² = 11 peças_pieces]



STRATUS 9 XISTO SUPERBRANCO (a)(f)
29,5x29,5x0,85 cm **P19 /peça_pieza**
[1m² = 11 peças_pieces]

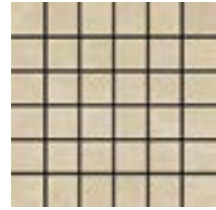

STRATUS 36 URBAN BONE (a)(f)
29,5x29,5x0,85 cm **P19 /peça_pieza**
[1m² = 11 peças_pieces]



STRATUS 36 LAVASTONE BEGE (a)(f)
29,5x29,5x0,85 cm **ANTISLIP RECT P19 /peça_pieza**
[1m² = 11 peças_pieces]

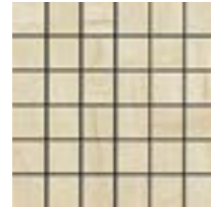

STRATUS 36 XISTO MARFIM (a)(f)
29,5x29,5x0,85 cm **P19 /peça_pieza**
[1m² = 11 peças_pieces]



STRATUS 9 XISTO MARFIM (a)(f)
29,5x29,5x0,85 cm **P19 /peça_pieza**
[1m² = 11 peças_pieces]



STRATUS 36 URBAN CRAFT (a)(f)
29,5x29,5x0,85 cm **P19 /peça_pieza**
[1m² = 11 peças_pieces]



STRATUS 36 LAVASTONE CRAFT (a)(f)
29,5x29,5x0,85 cm **ANTISLIP RECT P19 /peça_pieza**
[1m² = 11 peças_pieces]



DUO 36 XISTO MARFIM (a)
29,5x29,5x0,85 cm **P21 /peça_pieza**
[1m² = 11 peças_pieces]



DUO 8 XISTO MARFIM (a)
29,5x29,5x0,85 cm **P21 /peça_pieza**
[1m² = 11 peças_pieces]

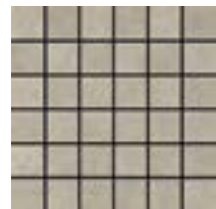

STRATUS 36 URBAN FOG (a)(f)
29,5x29,5x0,85 cm **P19 /peça_pieza**
[1m² = 11 peças_pieces]



STRATUS 36 LAVASTONE PLATINA (a)(f)
29,5x29,5x0,85 cm **ANTISLIP RECT P19 /peça_pieza**
[1m² = 11 peças_pieces]



STRATUS 36 XISTO MULTICOLOR (a)(f)
29,5x29,5x0,85 cm **P19 /peça_pieza**
[1m² = 11 peças_pieces]



STRATUS 9 XISTO MULTICOLOR (a)(f)
29,5x29,5x0,85 cm **P19 /peça_pieza**
[1m² = 11 peças_pieces]



STRATUS 36 URBAN GRIS (a)(f)
29,5x29,5x0,85 cm **P19 /peça_pieza**
[1m² = 11 peças_pieces]



STRATUS 36 LAVASTONE FOG (a)(f)
29,5x29,5x0,85 cm **ANTISLIP RECT P19 /peça_pieza**
[1m² = 11 peças_pieces]

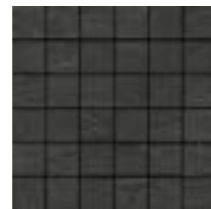

STRATUS 36 XISTO PRETO (a)(f)
29,5x29,5x0,85 cm **P19 /peça_pieza**
[1m² = 11 peças_pieces]



STRATUS 9 XISTO PRETO (a)(f)
29,5x29,5x0,85 cm **P19 /peça_pieza**
[1m² = 11 peças_pieces]



STRATUS 36 URBAN ANTRACITE (a)(f)
29,5x29,5x0,85 cm **P19 /peça_pieza**
[1m² = 11 peças_pieces]



STRATUS 36 LAVASTONE ANTRACITE (a)(f)
29,5x29,5x0,85 cm **ANTISLIP RECT P19 /peça_pieza**
[1m² = 11 peças_pieces]



DUO 36 XISTO PRETO (a)(f)
29,5x29,5x0,85 cm **P21 /peça_pieza**
[1m² = 11 peças_pieces]



DUO 8 XISTO PRETO (a)(f)
29,5x29,5x0,85 cm **P21 /peça_pieza**
[1m² = 11 peças_pieces]



LIMESTONE ANTIQUE MIST (b)
9,7x59,2x0,85 cm **RECT P09 /peça_pieza**



FRENCH STONE ANTIQUE DUNA (b)
9,7x59,2x0,85 cm **RECT P09 /peça_pieza**



STRATUS 9 SLATE ANTHRACITE (a)(f)
29,5x29,5x0,85 cm **P22 /peça_pieza**
[1m² = 11 peças_pieces]

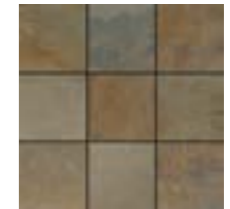

STRATUS 9 SLATE MULTICOLOR (a)(f)
29,5x29,5x0,85 cm **P22 /peça_pieza**
[1m² = 11 peças_pieces]



LIMESTONE ANTIQUE SAND (b)
9,7x59,2x0,85 cm **RECT P09 /peça_pieza**



FRENCH STONE ANTIQUE GREIGE (b)
9,7x59,2x0,85 cm **RECT P09 /peça_pieza**



INLAY GOLD (a)(b)(e)
27x35x0,98 cm **POL P25 /peça_pieza**
[1m² = 14 peças_pieces]



FILATI ONIX GOLD
14x59x0,98 cm **P14 /peça_pieza**
[1m² = 13 peças_pieces]



FILATI RAINFOREST GREEN
14x59x0,98 cm **P14 /peça_pieza**
[1m² = 13 peças_pieces]



FILATI CALACATTA CLASSIC
14x59x0,98 cm **P14 /peça_pieza**
[1m² = 13 peças_pieces]



BYZANTINE (a)(b)(d)
Base: Absolut Black + Baltic Grey + Statuario White
30x52x0,98 cm **P32 /peça_pieza**
[1m² = 9 peças_pieces]



TARSUS (a)(b)(d)(f)
Base: Baltic Grey + Statuario White
29x29x0,98 cm **P36 /peça_pieza**
[1m² = 12 peças_pieces]



PYRAMID BLACK & GREY (a)(b)(d)
Base: Absolut Black + Baltic Grey
29x30x0,98 cm **P28 /peça_pieza**
[1m² = 18 peças_pieces]



PYRAMID GREY (a)(b)(d)(f)
29x30x0,98 cm **P26 /peça_pieza**
[1m² = 18 peças_pieces]



MODULUS STATUARIO (a)(b)(d)(f)
33x37x0,98 cm **P32 /peça_pieza**
[1m² = 11 peças_pieces]



MODULUS ABSOLUT (a)(b)(d)
33x37x0,98 cm **P32 /peça_pieza**
[1m² = 11 peças_pieces]



PEAK ABSOLUT (a)(b)(d)
Base: Absolut Black + Statuario White
30x30x0,90 cm **P32 /peça_pieza**
[1m² = 14 peças_pieces]



HEXA STATUARIO (a)(b)(d)
Base: Absolut Black + Statuario White
24x30x0,98 cm **P32 /peça_pieza**
[1m² = 22 peças_pieces]



HERRINGBONE CALACATTA BIANCO (a)(b)(d)
29x31x0,90 cm **P18 /peça_pieza**
[1m² = 15 peças_pieces]



SHIFT SILVER CALACATTA (a)(b)(d)(e)
27x34x0,90 cm **P30 /peça_pieza**
[1m² = 14 peças_pieces]



HERRINGBONE CALACATTA ORO (a)(b)(d)
29x31x0,90 cm **P18 /peça_pieza**
[1m² = 15 peças_pieces]



HEXA GOLD CALACATTA (a)(b)(d)(e)
24x30x0,90 cm **P30 /peça_pieza**
[1m² = 22 peças_pieces]



TWIST BEGE
16,5x19x1,23 cm **P15 /peça_pieza**
[1m² = 41 peças_pieces]



TWIST GRIS
16,5x19x1,23 cm **P15 /peça_pieza**
[1m² = 41 peças_pieces]



LOOP WHITE COOL (a)
29x31x1,23 cm **P96 /peça_pieza**
[1m² = 15 peças_pieces]

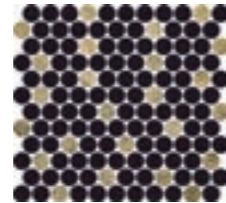

LOOP WHITE COOL (a)(b)
29x31x1,23 cm **P138 /peça_pieza**
[1m² = 15 peças_pieces]

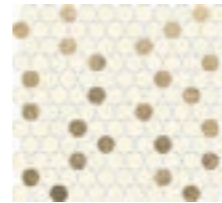

LOOP MARFIM SILVER (a)(b)
29x31x1,23 cm **P138 /peça_pieza**
[1m² = 15 peças_pieces]



CROSS 36 SILKEN BRANCO (a)
29,5x29,5x0,90 cm **P17/peça_pieza**
[1m² = 11 peças_pieces]



MULTIFORM ELEMENTS MIST (a)
29,5x29,5x0,90 cm **P20/peça_pieza**
[1m² = 11 peças_pieces]

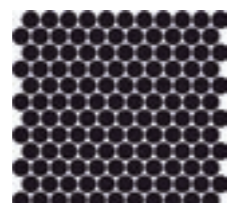

LOOP PRETO MATE (a)
29x31x1,23 cm **P96/peça_pieza**
[1m² = 15 peças_pieces]

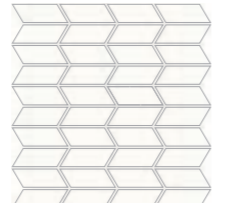

BITTY WHITE COOL (a)
29,5x29,5x1,23 cm **P26/peça_pieza**
[1m² = 12 peças_pieces]

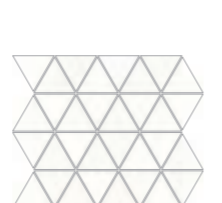

MOODY WHITE (a)(d)
Base: White Cool + Branco Oriente
27x30x0,90 cm **P20/peça_pieza**
[1m² = 14 peças_pieces]

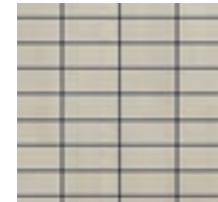

CROSS 36 SILKEN FOG (a)
29,5x29,5x0,90 cm **P17/peça_pieza**
[1m² = 11 peças_pieces]



MULTIFORM ELEMENTS SMOKE (a)
29,5x29,5x0,90 cm **P20/peça_pieza**
[1m² = 11 peças_pieces]



LOOP MARFIM MATE (a)
29x31x1,23 cm **P96/peça_pieza**
[1m² = 15 peças_pieces]



BITTY MARFIM MATE (a)
29,5x29,5x1,23 cm **P26/peça_pieza**
[1m² = 12 peças_pieces]

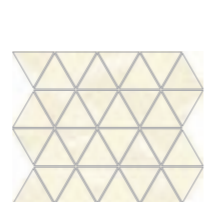

MOODY MARFIM (a)(d)
Base: Marfim Mate + Marfim Brilho
27x30x0,90 cm **P20/peça_pieza**
[1m² = 14 peças_pieces]



CROSS 36 SILKEN CORDA (a)
29,5x29,5x0,90 cm **P17/peça_pieza**
[1m² = 11 peças_pieces]

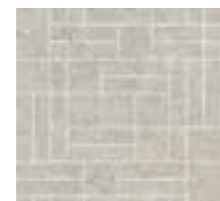

MULTIFORM ELEMENTS FOG (a)
29,5x29,5x0,90 cm **P20/peça_pieza**
[1m² = 11 peças_pieces]



LOOP ALLOY MATE (a)
29x31x1,23 cm **P96/peça_pieza**
[1m² = 15 peças_pieces]



BITTY ALLOY MATE (a)
29,5x29,5x1,23 cm **P26/peça_pieza**
[1m² = 12 peças_pieces]

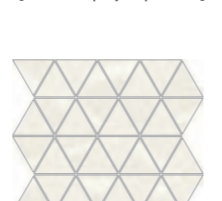

MOODY ALLOY (a)(d)
Base: Alloy Mate + Alloy Brilho
27x30x0,90 cm **P20/peça_pieza**
[1m² = 14 peças_pieces]



CROSS 36 SILKEN GRIS (a)
29,5x29,5x0,90 cm **P17/peça_pieza**
[1m² = 11 peças_pieces]

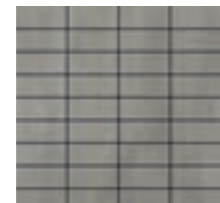

CROSS 36 SILKEN ANTRACITE (a)
29,5x29,5x0,90 cm **P17/peça_pieza**
[1m² = 11 peças_pieces]



LOOP SMOG MATE (a)
29x31x1,23 cm **P96/peça_pieza**
[1m² = 15 peças_pieces]



BITTY SMOG MATE (a)
29,5x29,5x1,23 cm **P26/peça_pieza**
[1m² = 12 peças_pieces]



MOODY MIX (a)(d)
Base: Preto Brilho + Smog Mate + Iron Brilho + Alloy Mate
27x30x0,90 cm **P20/peça_pieza**
[1m² = 14 peças_pieces]

BARRA STILETTO ORO (c)
0,5x59,2x0,90 cm RECT **P25/peça_pieza**

BARRA STILETTO PRATA (c)
0,5x59,2x0,90 cm RECT **P25/peça_pieza**



MULTIFORM ELEMENTS CARBON (a)
29,5x29,5x0,90 cm **P20/peça_pieza**
[1m² = 11 peças_pieces]



BITTY PRETO MATE (a)
29,5x29,5x1,23 cm **P26/peça_pieza**
[1m² = 12 peças_pieces]



LOKI ALMOND (a)(b)(f)
19,5x19,5x1,05 cm **P15 /peça_pieza**
[1m² = 26 peças_pieces]



LOKI WHITE (a)(b)(f)
19,5x19,5x1,05 cm **P15 /peça_pieza**
[1m² = 26 peças_pieces]



GRID ALMOND (a)(b)(f)
35x43x1,05 cm **P10 /peça_pieza**
[1m² = 12 peças_pieces]



GRID WHITE (a)(b)(f)
35x43x1,05 cm **P10 /peça_pieza**
[1m² = 12 peças_pieces]



LOKI HONEY (a)(b)(f)
19,5x19,5x1,05 cm **P15 /peça_pieza**
[1m² = 26 peças_pieces]



LOKI CHERRY (a)(b)(f)
19,5x19,5x1,05 cm **P15 /peça_pieza**
[1m² = 26 peças_pieces]



GRID HONEY (a)(b)(f)
35x43x1,05 cm **P10 /peça_pieza**
[1m² = 12 peças_pieces]



GRID CHERRY (a)(b)(f)
35x43x1,05 cm **P10 /peça_pieza**
[1m² = 12 peças_pieces]



LOKI WALNUT (a)(b)(f)
19,5x19,5x1,05 cm **P15 /peça_pieza**
[1m² = 26 peças_pieces]

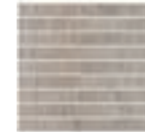

LOKI TAUPE (a)(b)(f)
19,5x19,5x1,05 cm **P15 /peça_pieza**
[1m² = 26 peças_pieces]



GRID WALNUT (a)(b)(f)
35x43x1,05 cm **P10 /peça_pieza**
[1m² = 12 peças_pieces]



GRID TAUPE (a)(b)(f)
35x43x1,05 cm **P10 /peça_pieza**
[1m² = 12 peças_pieces]

NOTAS · NOTES · NOTES · NOTAS

- (a) Os decorados colados em rede permitem obter um efeito de continuidade, podendo ser conjugados com qualquer formato da base.
- (a) The decors glued on to a mesh create an effect of continuity, and can be combined with any base size.
- (a) Les décors collés sur filet permettent d'obtenir un effet de continuité, qui peuvent être combinés avec n'importe quel format de la base.
- (a) Los decorados pegados sobre malla permiten obtener un efecto de continuidad, por lo que se pueden combinar con cualquier formato de base.

- (b) Existem várias peças diferentes, de acordo com o desenho do decorado, que devem ser aplicadas alternadamente, de modo a obter-se uma solução mais rica e variada.
- (b) here are different pieces, matching the design of the decorated tiles, which should be applied alternately in order to obtain a richer and more varied decoration.
- (b) Différentes pièces correspondent au dessin du décor. Il convient de les appliquer de façon alternée pour obtenir une disposition plus riche et plus variée.
- (b) Existen diversas piezas diferentes, de acuerdo con el diseño del decorado, que deben aplicarse de forma alterna, con el fin de obtener una solución más y variada.

- (c) A barra tem 2 lados distintos: uma face de brilho uniforme e a outra face com efeito escovado. Qualquer face da barra poderá ser aplicada, utilizando a que melhor se adapte ao ambiente.
- (c) This bar has 2 different sides: one side has a uniform brightness and the other side has a brushed effect. Both sides of the bar can be applied, according to the chosen ambience.
- (c) La barre a 2 côtés distincts : l'une des faces présente un brillant uniforme et l'autre a un effet brossé. On pourra appliquer l'une ou l'autre, en optant pour celle qui s'adapte le mieux à l'environnement.
- (c) La barra tiene 2 lados distintos: una cara tiene brillo uniforme y la demás tiene un efecto cepillado. Cualquier cara de la barra podrá aplicarse utilizando la que se adapte mejor al medio ambiente.

- (d) Decorado composto pela mistura de peças em acabamento mate e polido.
- (d) Decor composed of a mix of pieces with matt and polished finishes.
- (d) Décor composé d'un mélange de pièces avec des finitions matt et polie.
- (d) Decorado compuesto por una mezcla de piezas con acabados mate y pulido.

- (e) Dado o efeito de espelho deste produto, não devem ser utilizados utensílios ou produtos de limpeza ácidos ou abrasivos, os quais poderão danificar a decoração metálica.
- (e) Avoid using acid or abrasive cleaning products or utensils that may damage the metal finish and product mirror effect.
- (e) Pour préserver l'effet brillant miroir de ce produit, nous recommandons de ne pas utiliser la surface avec des instruments ou des nettoyeurs acides ou abrasifs car ils peuvent endommager l'aspect métal.
- (e) Debido al efecto espejo de este producto, no se deben utilizar utensilios ni productos de limpieza ácidos o abrasivos, ya que podrían dañar la decoración metálica.

- (f) Decorados aplicáveis em revestimento e, também, em pavimento.
- (f) Decors for wall tiles and also for floor tiles.
- (f) Décors applicables aussi bien en revêtements muraux, qu'en revêtements de sol.
- (f) Decorados aplicables en revestimiento y, también, en pavimento.

Relativamente aos decorados, especialmente nos produtos metalizados a ouro ou platina, não devem ser utilizados utensílios ou produtos de limpeza ácidos ou abrasivos, os quais poderão danificar a decoração. On decorative tile, especially on gold or platinum metallic surfaces, do not use tools or acid and/or abrasive cleaning products, which may damage the decorative surface. Pour le carrelage décor, en particulier les produits métallisés en or ou platine, des ustensiles ou des produits de nettoyage acides et/ou abrasifs ne doivent pas être utilisés car ils peuvent endommager la décoration. Con respecto a las decoraciones, especialmente en los productos metalizados en oro o platino, no se deben utilizar utensilios ni productos ácidos o abrasivos, ya que podrían dañar la decoración.



BOLD PINKY MATE _ BRANCO MATE

USEFUL INFORMATION

INFORMAÇÕES ÚTEIS · INFORMATIONS UTILES · INFORMACIÓN ÚTIL



BIBLIOTECA DE OBJETOS BIM
Através da Biblioteca de Objetos BIM Revigrés, disponível em www.revigrés.com, aceda, num único ficheiro, a todas as informações - imagem estética, certificações, informações técnicas e comerciais - e utilize-os na modelação de edifícios virtuais, através de ferramentas tridimensionais. Compatível com o software Autodesk Revit. Apoio técnico através do email bimsupport@revigrés.pt

BIM OBJECT LIBRARY
Through the Revigrés BIM Object Library, available at www.revigrés.com with access information - the aesthetic image, certifications, technical and commercial information - and use it to model virtual buildings using 3D tools. Compatible with Autodesk Revit architecture software. To request technical support send an email to bimsupport@revigrés.pt

BIBLIOTHÈQUE D'OBJETS BIM
Grâce à la bibliothèque d'objets BIM Revigrés, disponible sur www.revigrés.com, accédez, dans un seul fichier, à toutes les informations - image esthétique, certifications, informations techniques et commerciales - et utilisez-les dans la modélisation de bâtiments virtuels, à l'aide d'outils tridimensionnels. Compatible avec le logiciel Autodesk Revit. Assistance technique par e-mail bimsupport@revigrés.pt

BIBLIOTECA DE OBJETOS BIM
A través de la Biblioteca de Objetos BIM Revigrés, disponible en www.revigrés.com, puede acceder, en un único archivo, a toda la información - imagen estética, certificados, información técnica y comercial - y utilizarla en el modelado de edificios virtuales, mediante herramientas tridimensionales. Compatible con el programa Autodesk Revit. Asistencia técnica a través de la dirección de correo electrónico bimsupport@revigrés.pt

TIPOLOGIAS DE PRODUTOS · TYPES OF PRODUCTS · TYPOLOGIES DE PRODUITS · TIPOLOGÍAS DE PRODUCTOS



Revestimentos Cerâmicos Vidrados
Glazed ceramic wall tiles
Faïence pâte blanche
Revestimientos cerámicos vidriados



Revestimentos e Pavimentos em Grés porcelânico esmaltado
Glazed porcelain wall/floor tiles
Revêtements muraux et de sol en Grès cérame emailé
Revestimientos y pavimentos en Gres porcelánico esmaltado



Revestimentos e Pavimentos em Grés porcelânico técnico
Full body porcelain wall/floor tiles
Revêtements muraux et de sol en Grès cérame pleine masse
Revestimientos y pavimentos en Gres porcelánico técnico



(*) Grés Porcelânico Esmaltado adequado para revestimento interior e exterior.
(*) Glazed Porcelain suitable for internal and external walls.
(*) Grés Cérame Emailé convient aux murs intérieurs et extérieurs.
(*) Gres Porcelánico Técnico adecuado para revestimiento interior y exterior.



FULL BODY



DOUBLE LOAD



COLOURED BODY

ACABAMENTO DA SUPERFÍCIE · SURFACE FINISH · FINITION DE LA SUPERFICIE · ACABADO DE LA SUPERFICIE



MATE: superfície natural, não brilhante.
MATTE: natural surface, not shiny.
MAT: superficie naturelle, non brillante.
MATE: superficie natural, no brillante.



BRILHO: superfície brilhante, com alto grau de reflexão de luz.
GLOSS: shiny surface, with high degree of light reflection.
BRILLANT: surface brillant, avec haut niveau de reflet de la lumière.
BRILLO: superficie brillante, con alto grado de reflexión de la luz.

VARIAÇÕES DE TONALIDADE · COLOUR VARIATIONS · VARIATIONS DE TONALITÉ · VARIACIONES DE TONALIDAD



VARIAÇÃO LIGEIRA: produto com ligeira variação cromática.
SLIGHT VARIATION: product with slight colour variation.
VARIATION LÉGÈRE: produit présentant une petite variation de couleur.
VARIACIÓN LIGERA: producto con ligera variación cromática.



VARIAÇÃO MÉDIA: produto com evidente variação cromática.
MEDIUM VARIATION: product with visible colour variation.
VARIATION MOYENNE: produit présentant une variation de couleur évidente.
VARIACIÓN MEDIA: producto con evidente variación cromática.



VARIAÇÃO FORTE: produto com forte variação cromática.
HIGH VARIATION: product with strong colour variation.
VARIATION FORTE: produit présentant une forte variation de couleur.
VARIACIÓN FUERTE: producto con fuerte variación cromática.



VARIAÇÃO MUITO FORTE: produto com intensa variação cromática.
VERY WIDE RANGE: product with intense colour variation.
VARIATION TRÈS FORTE: produit présentant une intense variation de couleur.
VARIACIÓN MUY FUERTE: producto con intensa variación cromática.

TIPOS DE APLICAÇÃO · TYPES OF USE · TYPES D'APPLICATION · TIPOS DE APLICACIÓN



TRÁFEGO LIGEIRO
LIGHT TRAFFIC
TRAFIC LÉGER
TRÁFICO LIGERO



TRÁFEGO MÉDIO
MEDIUM TRAFFIC
TRAFIC MOYEN
TRÁFICO MEDIO



TRÁFEGO MÉDIO-FORTE
MEDIUM HEAVY TRAFFIC
TRAFIC MOYEN-ÉLEVÉ
TRÁFICO MEDIO FUERTE



TRÁFEGO FORTE
HEAVY TRAFFIC
TRAFIC ÉLEVÉ
TRÁFICO FUERTE



TRÁFEGO MUITO FORTE
VERY HEAVY TRAFFIC
TRAFIC TRÈS ÉLEVÉ
TRÁFICO MUY FUERTE

Recomendamos a colocação de um tapete nas áreas de comunicação com o exterior, a fim de eliminar as areias e matérias abrasivas.

Produtos de cores claras, nomeadamente com características antiderrapantes, são suscetíveis de limpezas mais exigentes e frequentes.

We recommend that a doormat be placed at the entrance of any doors leading outside, in order to remove any abrasive particles. (e.g.: sand). Light-coloured tiles, namely with non-slip characteristics, undergo more frequent deep cleaning.

Pour les revêtements muraux, nous conseillons le carreaux rectifiés. Toutefois, si vous appliquez le naturel (sans arêtes rectifiées), nous vous conseillons d'effectuer les joints.

Les produits de couleurs claires ayant, notamment, des caractéristiques antidérapantes, sont sujets à un nettoyage plus exigeant et plus fréquent.

Le recomendamos la colocación de una alfombra en las áreas de comunicación con el exterior, con el fin de eliminar las arenas y los materiales abrasivos. Los productos de color claro, especialmente aquellos con propiedades antideslizantes, pueden requerir una limpieza más exhaustiva y frecuente.

As utilizações recomendadas são meramente indicativas; os valores podem variar em função da especificidade dos espaços onde os materiais serão aplicados. No caso de ser necessário alguma informação adicional, a Direção Técnica poderá fornecê-la, pelo que solicitamos o contacto para: revigrés@revigrés.pt

The recommended types of applications are indicative, as each may vary depending on the specific areas where the products are applied. For more information please contact us at: revigrés@revigrés.pt

Les utilisations recommandées sont indiquées uniquement à titre indicatif; les valeurs peuvent varier en fonction de la spécificité des espaces où les matériaux seront appliqués. Toutefois, pour toutes informations complémentaires, la direction technique reste à votre disposition. Contactez-nous à: revigrés@revigrés.pt

Los usos recomendados son meramente indicativos; los valores pueden variar en función de la especificidad de los espacios donde se aplicarán los materiales. En caso de que sea necesario alguna información adicional, la Dirección Técnica podrá facilitarla, por lo que le pedimos que se ponga en contacto con: revigrés@revigrés.pt

TIPOS DE APLICAÇÃO · TYPES OF USE · TYPES D'APPLICATION · TIPOS DE APLICACIÓN	CLASSIFICAÇÃO · CLASSIFICATION · CLASSEMENT · CLASIFICACIÓN				
	1	2	3	4	5
EM REVESTIMENTO MURAL · IN WALL TILES · EN REVÊTEMENT MURAL · EN LOS REVESTIMIENTO Fachadas (revestimento de exterior) · Façades (exterior wall tiles) Façades (revêtement extérieur) · Fachadas (revestimento de exterior)	•	•	•	•	•
Revestimento (paredes) · Wall tiles · En revêtement mural · Revestimiento (paredes)	•	•	•	•	•
WC e Quartos Bathrooms and bedrooms WC et chambres WC y Cuartos de baño	•	•	•	•	•
Habitacões Homes Habitations Edifícios Toda a casa excepto Hall de entrada e triângulo Cozinha (bancada – fogão – frigorífico) Anywhere at home, except entrance halls and kitchen triangle (counter – cooker – refrigerator) Toute la maison, sauf le hall d'entrée et le triangle cuisine (plan de travail - cuisinière - réfrigérateur) Toda la casa excepto la entrada y el triángulo de la Cocina (encimera – cocina – frigorífico)		•	•	•	•
Vivendas Villas Pavillons Viviendas Toda a casa · Entire home · Toute la maison · Toda la casa		•	•	•	•
Escolas · Schools · Établissements scolaires · Escuelas			•	•	•
Lojas · Centros comerciais · Shops · Shopping centers Magasins · Centres commerciaux · Tiendas · Centros comerciales			•	•	•
Hotéis · Hotels · Hôtels · Hoteles			•	•	•
Organismos públicos · Public buildings Institutions publiques · Organismos públicos			•	•	•
Aeroportos · Airports · Aéroports · Aeropuertos			•	•	•
Escritórios · Bancos · Offices · Banks Bureaux · Banques · Oficinas · Bancos			•	•	•
Cinemas · Teatros · Museus · Cinemas · Theatres · Museums Cinéma · Théâtres · Musées · Cines · Teatros · Museos			•	•	•
Restaurantes · Bares · Cafés · Restaurants · Bars · Cafés Restaurants · Bars · Cafés · Restaurants · Bares · Cafés			•	•	•
Áreas Desportivas · Sports facilities · Zones sportives · Áreas Deportivas				•	•
Espaços Públicos · Public areas · Espaces publics · Espacios Públicos				•	•
Discotecas · Nightclubs · Discothèques · Discotecas				•	•
Hospitais · Hospitals · Hôpitaux · Hospitales				•	•
Supermercados · Supermarkets · Supermarchés · Supermercados				•	•
Estações · Railway stations · Gares · Estaciones					•
Indústria · Industry · Industrie · Industria					•

ÍCONES _ ICONS _ ICONES _ ICONOS

VALOR DE RESISTÊNCIA À DERRAPAGEM (RD) PELO MÉTODO DO PÊNDULO · SLIP RESISTANCE VALUE (RD) THROUGH THE PENDULUM METHOD
VALEUR DE RÉSISTANCE AU DÉRAPAGE (RD) PAR LA METHODE DU PENDULE · VALOR DE RESISTENCIA AL DESLIZAMIENTO (RD) POR EL MÉTODO DEL PÊNDULO

NORMA . STANDARD . NORME . NORMA UNE-ENV 12633



CLASS 1
15 < RD ≤ 35

SUPERFÍCIE NATURAL, POUCO ANTIDESLIZANTE
Produtos indicados para locais secos e sem rampas inclinadas.
NATURAL SURFACE, SLIGHTLY NON-SLIP
Products suited to dry areas without sloped ramps.
SUPERFICIE NATURELLE, LÉGÈREMENT ANTIDÉRAPANTE
Produits indiqués pour des lieux secs et sans rampes inclinées.
SUPERFÍCIE NATURAL, POCO ANTIDESLIZANTE
Productos indicados para lugares secos y sin rampas inclinadas.

CLASS 2
35 < RD ≤ 45

SUPERFÍCIE RUGOSA, COM CARACTERÍSTICAS ANTIDESLIZANTES
Produtos indicados para zonas interiores húmidas (exemplos: entradas de edifícios, esplanadas, escadas, vestiários, casas-de-banho / lavabos e cozinhas).
ROUGH SURFACE, WITH NON-SLIP CHARACTERISTICS
Products suited to damp indoor areas (e.g. building entrances, terraces, stairs, cloakrooms, bathrooms/lavatories and kitchens).
SUPERFICIE RUGUEUSE, AVEC CARACTÉRISTIQUES ANTIDÉRAPANTES
Produits indiqués pour les zones intérieures humides (exemples : entrées de bâtiments, esplanades, escaliers, vestiaires, salles de bain / lavabos et cuisines).
SUPERFICIE RUGOSA, CON CARACTERÍSTICAS ANTIDESLIZANTES
Productos indicados para zonas interiores húmedas (ejemplos: entradas de edificios, terrazas, escaleras, vestuarios, cuartos de baño / lavabos y cocinas).

CLASS 3
RD ≤ 45

SUPERFÍCIE MUITO RUGOSA, MUITO ANTIDESLIZANTE
Produtos indicados para as seguintes áreas: zonas interiores onde, além de água, possam haver agentes como gordura, lubrificantes, entre outros, que reduzam a resistência à derrapagem (exemplos: cozinhas industriais, indústrias, zonas de uso industrial, matadouros, parques de estacionamento) e zonas exteriores (exemplos: piscinas, entre outros).
VERY ROUGH SURFACE, HIGHLY NON-SLIP
Products suited to the following areas: indoor areas which, in addition to water, may have grease, lubricants and similar substances which reduce slip resistance (e.g. industrial kitchens, factories, industrial use areas, slaughterhouses, parking lots) and outside areas (e.g. swimming pools, etc.).
SUPERFICIE TRÈS RUGUEUSE, TRÈS ANTIDÉRAPANTE
Produits indiqués pour les zones suivantes : zones intérieures où, en plus de l'eau, il peut y avoir des agents tels que graisse, lubrifiants, entre autres, qui réduisent la résistance au dérapage (exemples : cuisines industrielles, industries, zone à usage industriel, abattoirs, parkings) et zones extérieures (exemples : piscines, entre autres).
SUPERFICIE MUY RUGOSA, MUY ANTIDESLIZANTE
Productos indicados para las siguientes áreas: zonas interiores donde, además de agua, pueda haber agentes tales como grasa, lubricantes, entre otros, que reduzcan la resistencia al deslizamiento (ejemplos: cocinas industriales, industrias, zonas de uso industrial, mataderos, aparcamientos) y zonas exteriores (ejemplos: piscinas, entre otros).

NORMA . STANDARD . NORME . NORMA ANSI A137 (DCOF)



APLICAÇÕES EM PAVIMENTO FLOOR APPLICATIONS APPLICATIONS AU SOL APLICACIONES EN PAVIMENTO	VALOR DCOF QUANDO MOLHADO TARGET DCOF WET VALEUR DCOF LORSQUE HUMIDE VALOR DCOF CUANDO ESTÁ HÚMEDO	ADEQUADO SUITABLE ADAPTÉ ADEQUADO
INTERIOR SECO E NIVELADO DRY & LEVEL INTERIOR INTÉRIEUR SEC ET NIVELÉ INTERIOR SECO Y NIVELADO	N/A	✓
INTERIOR MOLHADO E NIVELADO WET & LEVEL INTERIOR INTÉRIEUR HUMIDE ET NIVELÉ INTERIOR HÚMEDO Y NIVELADO	≥ 0,42	✓
APLICAÇÕES NO EXTERIOR EXTERIOR APPLICATIONS APPLICATIONS À L'EXTÉRIEUR APLICACIONES EN EL EXTERIOR	≥ 0,60	
RAMPAS E INCLINAÇÕES RAMPAS & INCLINES RAMPES ET PENTES RAMPAS E INCLINACIONES	≥ 0,65	

NORMA . STANDARD . NORME . NORMA BS 7976-2



FLOORS (PTV) PENDULUM TEST VALUE 4S (*)	POTENCIAL DE ESCORREGAMENTO SLIP POTENTIAL POTENTIEL DE GLISSEMENT POTENCIAL DE DESLIZAMIENTO
0-24	Muito High Très Muy
25-35	Moderado Moderate Modéré Moderado
36+	Pouco Low Légèrement Poco
75+	Muito Pouco Extremely Low Très peu Muy Poco

(*) *4S* - Identifica a borracha tipo #96 (normalizada que simula o calçado).
(*) *4S* - Identifies rubber type #96 (standard simulated Shoe Sole).
(*) *4S* - Identifie le caoutchouc type #96 (normalisé qui simule la sole des chaussures).
(*) *4S* - Identifica el caucho tipo #96 (estándar que simula la suela del calzado).

ÍCONES _ ICONS _ ICONES _ ICONOS

NORMA . STANDARD . NORME . NORMA DIN 51130

DIN 51130	RESISTÊNCIA AO ESCORREGAMENTO · ANTI SLIP RESISTANCE · RÉSISTANCE À LA GLISSANCE · RESISTENCIA ANTIDESLIZAMIENTO
R9 6° ≤ angle < 10°	BAIXO ATRITO LOW FRICTION FROTTEMENT FAIBLE BAJA FRICCIÓN Adequado para pisos interiores secos (ex: salas, corredores, quartos, escritórios, etc.). Suitable for internal dry floor (e.g. living areas, hallways, bedrooms, offices, etc.). Convient aux sols intérieurs secs (ex. : les séjours, les couloirs, les chambres à coucher, les bureaux, etc.) Adequado para suelos interiores secos (p.ej.: salones, pasillos, cuartos, oficinas, etc.)
R10 10° ≤ angle < 19°	ATRITO MÉDIO MEDIUM FRICTION FROTTEMENT MOYEN FRICCIÓN MEDIA Adequado para pisos interiores, humedecidos ocasionalmente (ex: wc públicos, banheiros, cantinas, garagens, etc.). Suitable for internal domestic floors subject to occasional wetting (e.g. public toilets, bathrooms, cafeterias, garages, etc.). Convient aux sols intérieurs, occasionnellement humides (ex. : les toilettes publiques, les salles de bains, les cantines, les garages, etc.) Adequado para suelos interiores, humedecidos ocasionalmente (p.ej.: baños públicos, baños, comedores, garajes, etc.)
R11 19° ≤ angle < 27°	ATRITO ALTO HIGH FRICTION FROTTEMENT ÉLEVÉ ALTA FRICCIÓN Adequado para áreas exteriores (ex: pátios, varandas, rampas, etc), envolventes de piscinas e áreas interiores em permanente contacto com água (ex: balneários públicos, vestiários, saunas, etc) Suitable for external areas (e.g. patios and walkways), pool surrounds and internal areas subject to constant wetting (e.g. public toilets, dressing rooms, saunas, etc.). Convient aux surfaces extérieures (ex. : les patios, les balcons, les rampes, etc.), aux abords des piscines et aux surfaces intérieures en contact permanent avec l'eau (ex. : les douches publiques, les vestiaires, les saunas, etc.) Adequado para zonas exteriores (p.ej.: patios, terrazas, rampas, etc.), zonas adyacentes a piscinas y zonas interiores en contacto permanente con el agua (p.ej.: vestuarios públicos, saunas, etc.)
R12 27° ≤ angle < 35°	ATRITO MUITO ALTO HIGH FRICTION FROTTEMENT TRÈS ÉLEVÉ FRICCIÓN MUY ALTA Adequado para áreas exteriores, rampas inclinadas, áreas industriais e áreas interiores em permanente contacto com água. Suitable for external areas, slopes, industrial areas and internal wet areas. Convient aux surfaces extérieures, aux rampes en pente, aux sites industriels et aux surfaces intérieures en contact permanent avec l'eau. Adequado para zonas exteriores, rampas inclinadas, zonas industriales y zonas interiores en contacto permanente con el agua
angle ≥ 35°	ATRITO ELEVADÍSSIMO VERY HIGH FRICTION FROTTEMENT EXTRÊMEMENT ÉLEVÉ FRICCIÓN ALTÍSSIMA Adequado para áreas exteriores, rampas muito acentuadas, áreas com requisitos de alta segurança (ex: indústrias, zona de contacto permanente com gorduras, etc) Suitable for external areas, slopes, and high-resistance requirement external areas (e.g. industrial, greasy areas, etc.). Convient aux surfaces extérieures, aux rampes en pente très raide, aux zones ayant des exigences élevées en matière de sécurité (ex. : les sites industriels, les zones de contact permanent avec les graisses, etc.) Adequado para zonas exteriores, rampas muy inclinadas, zonas con requisitos de alta seguridad (p.ej.: industrias, zonas en contacto permanente con grasas, etc.)

NORMA . STANDARD . NORME . NORMA DIN 51097

DIN 51097	RESISTÊNCIA AO ESCORREGAMENTO · ANTI SLIP RESISTANCE · RÉSISTANCE À LA GLISSANCE · RESISTENCIA ANTIDESLIZAMIENTO
A 12° ≤ angle < 18°	BAIXO ATRITO LOW FRICTION FROTTEMENT FAIBLE BAJA FRICCIÓN Adequado para pisos secos. Suitable for dry floors. Convient aux sols secs. Adequada para suelos secos.
B 18° ≤ angle < 24°	ATRITO MÉDIO MEDIUM FRICTION FROTTEMENT MOYEN FRICCIÓN MEDIA Adequado para pisos de algum contacto com água (ex: wc, chuveiros Spa). Suitable for floors subject to occasional wetting (e.g. toilets, spa showers). Convient aux sols ayant un certain contact avec l'eau (toilettes, douches, Spa). Adequada para suelos con algún contacto con el agua (p.ej.: W.C., duchas Spa).
C angle ≥ 24°	ATRITO ALTO HIGH FRICTION FROTTEMENT ÉLEVÉ BAJA FRICCIÓN Adequado para pisos em permanente contacto com água (ex: áreas envolventes de piscinas, pisos de jacuzzi, etc) e rampas molhadas. Suitable for floors wet (e.g. pool surrounds, jacuzzi floors, etc.) and walkways in wet areas. Convient aux sols en contact permanent avec l'eau (ex. les abords de piscines, les sols de jacuzzi, etc.) et aux rampes humides. Adequada para suelos en contacto permanente con el agua (p.ej.: zona adyacente a piscinas, suelos de jacuzzi, etc.) y rampas mojadas.

NORMA . STANDARD . NORME . NORMA NF UPEC



CLASSIFICAÇÃO UPEC - Norma NF EN 14411 (Centre Scientifique et technique du Bâtiment - CSTB, França):
Mosaicos cerâmicos - Definições, classificações, características e marcação. No caso de ser necessária a classificação de um produto específico, a Direção Técnica poderá fornecê-la, pelo que solicitamos o contacto para: revigres@revigres.pt

UPEC CLASSIFICATION - French Standard NF EN 14411 (Centre Scientifique et technique du Bâtiment - CSTB, France):
Ceramic mosaics - Definitions, classifications, characteristics and marking. When a specific product needs to be classified, the Technical Management may provide it so we request contact to: revigres@revigres.pt

CLASSEMENT UPEC - Norme française NF EN 14411 (Centre Scientifique et technique du Bâtiment - CSTB, France):
Carreaux céramiques - Définitions, classification, caractéristiques et marquage. Si la classification d'un produit spécifique est nécessaire, la direction technique pourra la fournir. Pour cela, nous vous prions de nous contacter à: revigres@revigres.pt

CLASIFICACIÓN UPEC - Norma Francesa NF EN 14411 (Centre Scientifique et technique du Bâtiment - CSTB, Francia):
Mosaicos cerámicos - Definiciones, clasificaciones, características y marcación. En caso de necesitar la clasificación de un producto en concreto, puede solicitarla al Departamento Técnico en la dirección: revigres@revigres.pt

U RESISTÊNCIA À ABRASÃO
RESISTANCE TO ABRASION
RÉSISTANCE A L' ABRASION
RESISTENCIA A LA ABRASIÓN

P RESISTÊNCIA MECÂNICA
MECHANICAL RESISTANCE
RÉSISTANCE MECANIQUE
RESISTENCIA MECÁNICA

E COMPORTAMENTO EM PRESENÇA DE ÁGUA
BEHAVIOUR IN WATER PRESENCE
COMPORTEMENT EN PRESENCE D'EAU
COMPORTAMIENTO CON PRESENCIA DE AGUA

C RESISTÊNCIA A PRODUTOS QUÍMICOS
CHEMICAL PRODUCTS RESISTANCE
RÉSISTANCE AUX PRODUITS CHIMIQUES
RESISTENCIA A PRODUCTOS QUÍMICOS



CALIBRES _ CALIBRE _ CALIBRES _ CALBRE

As dimensões exatas - em centímetros - dos produtos com aresta retificada referidas ao longo do catálogo, são relativas ao calibre mais usual. As dimensões dos restantes calibres estão indicadas na tabela de calibres:

The exact sizes (in cm) of the products with rectified edges shown throughout the catalogue refer to the most common caliber. The sizes of other calibres are shown in the calibre table:

Les dimensions exactes des produits à arête rectifiée, en centimètres, mentionnés dans le catalogue se rapportent au gabarit le plus courant. Les dimensions des autres gabarits sont indiquées dans le tableau des gabarits:

Las dimensiones exactas, en centímetros, de los productos con arista rectificada referidas a lo largo del catálogo, se refieren al calibre más habitual. Las dimensiones de los restantes calibres están indicadas en la tabla de calibres:

MODULARIDADE _ MODULARITY MODULARITÉ _ MODULARIDAD

O calibre mais usual (**6C**) apresenta uma coordenação modular com junta de 2mm. Aplicável a todo o portfólio de produtos.

The most common caliber (**6C**) has a modular coordination with a 2mm joint. Applicable to the entire product portfolio.

Le calibre le plus courant (**6C**) a une coordination modulaire avec un joint de 2 mm. Applicable à l'ensemble du portefeuille de produits.

El calibre más común (**6C**) tiene una coordinación modular con una articulación de 2 mm. Aplicable a toda la cartera de productos.

TABELA DE CALIBRES · CALIBRE TABLE · TABLEAU DES CALIBRES · TABLA DE CALIBRES



NAT MATT NAT	FORMATO SIZE FORMAT FORMATO (CM)	CALIBRE (CM)					
		2	1	0 (dimensão nominal) (nominal size)	09	08	
	7,5			7,60	7,40		
	15	15,10	15,06	15,02	14,98	14,94	14,90
	20	20,15	20,09	20,03	19,97	19,91	19,85
	30	30,22	30,13	30,04	29,95	29,86	29,77
	40	40,30	40,18	40,06	39,94	39,82	39,70
	45	45,35	45,21	45,07	44,93	44,79	44,65
	60	60,45	60,27	60,09	59,91	59,73	59,55
	75	75,50	75,30	75,10	74,90	74,70	74,50
	90	90,50	90,30	90,10	89,90	89,70	89,50



RECT MATT RECT SOFT GRIP SILK	POL LAP	FORMATO NOMINAL SIZE FORMAT FORMATO (CM)	CALIBRE (CM)			
			0	6C	3C	
		9,7		9,70	9,60	± 0,1%
		14,65		14,65	14,50	± 0,1%
		19,6		19,60	19,40	± 0,1%
		29,5		29,50	29,20	± 0,1%
		39,4		39,40	39,00	± 0,1%
		43,5	43,40			± 0,1%
		44,35		44,35	43,90	± 0,1%
		59,2		59,20		± 0,1%
		87	87,00			± 0,1%
		88,9		88,90		± 0,1%
		118,6	120,00	118,60		± 0,1%
		178,0	180,00	178,00		± 0,1%

Os valores a bold respeitam ao calibre mais usual de cada formato.
Values listed in bold refer to the usual calibre of each format.
Les valeurs en gras sont relatifs au calibre le plus habituel de chaque format.
Los valores en negrita respetan el calibre más habitual de cada formato.

Na conjugação de produtos e/ou acabamentos (natural, rectificado, polido, etc) diferentes na mesma área (do revestimento ou do pavimento), o calibre dos produtos deve ser igual - solicitamos esta indicação ao realizar a encomenda. No formato 30x60cm, não é possível conjugar Revestimento Cerâmico de aresta normal com outras tipologias; neste formato, a conjugação de produtos de diferentes tipologias só é possível com a aresta retificada.

When combining different products and/or finishes (natural, rectified, polished, etc) in the same area (of the wall or floor tiles), the calibre of the products must be the same - in this case, please inform us when placing your order. In 30x60 cm format, Ceramic Wall Tile with normal edges cannot be combined with other types; in this format, different types of products can only be combined with rectified edges.

Lors de l'association de produits et/ou finitions (naturelle, rectifiée, polie, etc) différents sur une même surface (du revêtement ou du sol), le calibre des produits doit être identique. - Nous vous demanderons de fournir cette information lors de votre commande. Dans le format 30x60cm, il n'est pas possible de conjuguer Revêtement céramique à arête normale, avec d'autres typologies; dans ce format, la conjugaison de produits de différentes typologies n'est possible qu'avec l'arête rectifiée.

Para combinar varios productos y/o acabados (natural, rectificado, pulido, etc) diferentes en la misma área (de revestimiento o de pavimento), deben coincidir los calibres de los productos, le solicitamos esta indicación al realizar el pedido. En el formato 30x60cm, no es posible combinar el Revestimiento Cerámico de arista normal con otras tipologias; en este formato, la combinación de productos de distintas tipologias solo es posible con la arista rectificada.



JUNTA: 2 mm
JOINT: 2 mm

SUPERFÍCIE · SURFACE · SURFACE · SUPERFICIE

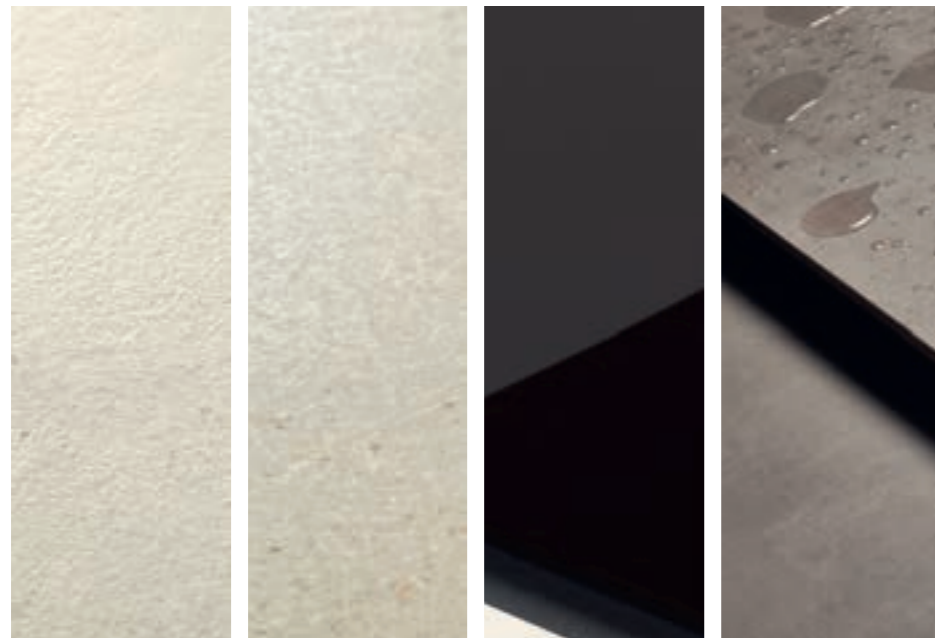

NATURAL
NATURAL
NATURELLE
NATURAL

LAPADO
LAPPED
LUSTRE
LAPADO

POLIDO
POLISHED
POLI
PULIDO

SOFT GRIP

SOFT GRIP é um acabamento superficial inovador, suave ao toque mas com propriedades antiderrapantes, permitindo a continuidade perfeita entre espaços interiores e exteriores. Com uma elevada resistência a manchas e a químicos e de fácil limpeza e manutenção, resulta em produtos adequados para múltiplas aplicações: revestimento, pavimento ou fachada, em espaços públicos ou residenciais.

SOFT GRIP is an innovative surface finish, smooth with non slip properties to ensure perfect continuity between indoor and outdoor spaces. With high resistance to stains and chemicals while offering easy cleaning and maintenance, it results in products suitable for multiple uses: walls, floors or façades, in public or residential spaces.

SOFT GRIP est une finition de surface innovante, douce au toucher mais aux propriétés antidérapantes, permettant une parfaite continuité entre les espaces intérieurs et extérieurs. Avec une forte résistance aux taches et aux produits chimiques et un nettoyage et un entretien faciles, il en résulte des produits adaptés à de multiples applications: revêtement, plancher ou façade, dans les espaces publics ou résidentiels.

SOFT GRIP es un innovador acabado superficial, suave al tacto, pero con propiedades antideslizantes, lo que permite una continuidad perfecta entre espacios interiores y exteriores. Gracias a su gran resistencia a manchas y productos químicos es fácil de limpiar y mantener. Los productos resultantes son adecuados para diversas aplicaciones: revestimientos, pavimentos o fachadas en espacios públicos o residenciales.

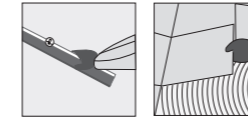

ANTES DO ASSENTAMENTO

O MATERIAL

Confirmar se existe material suficiente para realizar toda a obra e se todas as caixas pertencem à mesma Qualidade, Tonalidade e Calibre. No caso de pretender combinar produtos diferentes, deverá utilizar-se materiais com arestas retificadas e produtos com o mesmo calibre.

O SUPORTE

Verificar que o suporte não apresenta irregularidades de planimetria superiores a 5mm. Caso contrário, deverá proceder-se ao seu nivelamento.

DURANTE O ASSENTAMENTO

O MATERIAL

Aconselha-se a utilização, alternada, de mosaicos retirados de várias caixas de modo a uniformizar a variabilidade do produto colocado. Tecnicamente, recomenda-se a aplicação de materiais em contrafiada a 1/4 da peça. Não se recomenda a aplicação em contrafiada a 1/2. Caso o produto tenha um padrão irregular, a sua aplicação deve ser aleatória, isto é, o padrão deve ser aplicado em diferentes direções. Aconselha-se a utilização de sistemas de nivelamento que evitam a criação de desníveis durante a colocação dos ladrilhos, tanto em pavimentos como em revestimentos, nomeadamente, em formatos 30x30cm e superiores. Utilizando sempre dupla colagem.

AS JUNTAS

De modo a prevenir o potencial descolamento do material cerâmico, é aconselhada a aplicação do produto com juntas. Existem vários tipos de juntas:

a) Junta de colocação: espaço regular deixado entre duas peças.

Juntas mínimas recomendadas:

- Acabamento NAT, MATT NAT: 4mm
- Acabamento RECT, MATT RECT, SOFT, LAP, POL, SILK, SOFT GRIP: 2mm
- Revestimentos exteriores: 5mm
- Piso radiante: 4mm

O preenchimento das juntas de colocação deve ser efetuado na diagonal em relação às juntas.

b) Junta de fracionamento: subdivide o revestimento em áreas mais pequenas aliviando as tensões geradas. Recomenda-se a sua utilização em áreas com as seguintes dimensões:

Pavimentos:

- Interiores: a partir de 32 m2, ou quando um dos lados é superior a 8 metros contínuos.
- Exteriores: a partir de 25 m2, ou quando um dos lados é superior a 5 metros contínuos.

Revestimentos:

- Interiores: a partir de 32 m2, ou quando um dos lados é superior a 8 metros.
- Exteriores: deve efetuar-se um fracionamento na horizontal em cada 3 metros, e na vertical em cada 5 metros.

c) Junta perimetral ou de esquina: encontra-se na mudança de planos, quer no encontro entre paredes e pavimentos, quer nas esquinas de paredes.

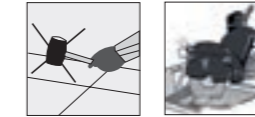

CORTE / FUROS

Os cortes / furos do material dependem da tipologia de produto.

No caso particular do porcelanato, que se caracteriza pela sua baixa absorção de água e elevada resistência mecânica, deve-se utilizar um disco / broca diamantados (ver quadro página 388).

DEPOIS DO ASSENTAMENTO

PROTEÇÃO

Após o assentamento do material cerâmico e antes da conclusão da obra, recomenda-se que todo o pavimento seja devidamente protegido, de modo a evitar que a superfície fique danificada pela movimentação de pessoas e/ou materiais afetos aos trabalhos.

LIMPEZA

No final da obra, o material deve ser limpo de toda a sujidade, com produtos químicos adequados aos tipos de resíduos existentes. É importante obedecer às instruções de aplicação destes produtos e ter a absoluta certeza que os mesmos não contêm ácido fluorídrico. Recomendamos que estes produtos sejam ensaiados previamente numa peça de reserva.

É fundamental que todos os resíduos e produtos químicos utilizados sejam completamente removidos, com várias passagens de água limpa.

No caso de material polido, a camada superficial de impermeabilizante deve ser removida, de modo a restituir o brilho original do material. Para tal, recomenda-se a sua remoção com uma esponja utilizando um detergente próprio, álcool ou diluente celuloso.

Produtos de cores claras, nomeadamente com características antiderrapantes, são suscetíveis de limpezas mais exigentes e frequentes.

MANUTENÇÃO

A manutenção e limpeza dos produtos cerâmicos é muito prática e fácil. Para a sua limpeza diária, deve-se utilizar água (de preferência tépida) e um detergente neutro. É recomendável que a utilização desse detergente seja feita em quantidades diminutas, de modo a que o mesmo possa ser completamente removido após a limpeza.

Nos acabamentos rústicos e antideslizantes, é conveniente a utilização de uma escova de fibra dura, para extrair a sujidade que se acumula na superfície rugosa.

Para uma boa conservação do produto, recomendamos a colocação de tapetes nas zonas de maior passagem / tráfego, nomeadamente nas áreas de comunicação com o exterior, de modo a evitar-se a circulação de areias, prejudiciais a qualquer tipo de pavimento.

Relativamente aos decorados, especialmente nos produtos em vidro e/ou metalizados a ouro ou platina, não devem ser utilizados utensílios ou produtos de limpeza ácidos e/ou abrasivos, os quais poderão danificar a decoração.

Para informação mais detalhada, consultar: Manual Técnico - Boas práticas de Assentamento



SIGNIFICA.	ACABAMENTO (SUPERFÍCIE)		ACABAMENTO (ARESTA)	
NAT.	Natural.	Natural.	Normal.	
MATT NAT.	Mate Natural.	Natural.	Normal.	
RECT.	Retificado.	Natural.	Retificada.	
MATT RECT.	Mate Retificado.	Natural.	Retificada.	
SOFT.	Amaciado Mate.	Natural.	Retificada.	
POL.	Polido.	Polida.	Retificada.	
LAP.	Lapado.	Lapada.	Rectificada.	
SOFT GRIP	Mate Retificado.	Natural.	Rectificada.	
SILK	Amaciado Mate.	Natural.	Rectificada.	

MEANS.	FINISH (SURFACE)		FINISH (EDGES)	
Nat.	Natural.	Natural.	Normal.	
Matt Nat.	Matt Natural.	Natural.	Normal.	
Rect.	Rectified.	Natural.	Rectified.	
Matt Rect.	Matt Rectified.	Natural.	Rectified.	
Soft.	Soft Matt.	Natural.	Rectified.	
Pol.	Polished.	Polished.	Rectified.	
Lap.	Lapped.	Lapped.	Rectified.	
SOFT GRIP	Matt Rectified.	Natural.	Rectified.	
SILK	Soft Matt.	Natural.	Rectified.	

FINITION (SURFACE)	FINITION (ARÊTE)	
NAT.	Naturel.	Naturelle.
MATT NAT.	Mat Naturel.	Naturelle.
RECT.	Rectifié.	Naturelle.
MATT RECT.	Mat Rectifié.	Naturelle.
SOFT.	Satiné Mat.	Naturelle.
POL.	Poli.	Poli.
LAP.	Lustré.	Lustré.
SOFT GRIP	Mat Rectifié.	Naturelle.
SILK	Satiné Mat.	Naturelle.

ACABADO (SUPERFÍCIE)	ACABADO (ARISTA)	
NAT.	Natural.	Normal.
MATT NAT.	Mate Natural.	Normal.
RECT.	Rectificado.	Rectificada.
MATT RECT.	Mate Rectificado.	Rectificada.
SOFT.	Suave Mate.	Rectificada.
POL.	Pulido.	Rectificada.
LAP.	Lapado.	Rectificada.
SOFT GRIP	Mate Rectificado.	Rectificada.
SILK	Suave Mate.	Rectificada.

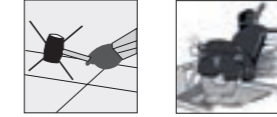
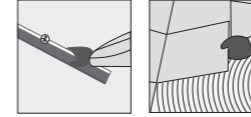
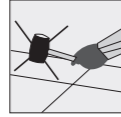
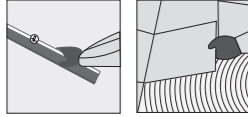

BEFORE LAYING THE MATERIAL

THE MATERIAL

Check to see that enough material has been delivered to complete the work and if all boxes are the same Quality, Shade and Calibre. If you wish to combine different products, use material with rectified edges and products of the same calibre.

THE SUBSTRATTE

Make sure the substrate shows no signs of unevenness greater than 5mm. Otherwise it must be levelled.

DURING THE LAYING

THE MATERIAL

It is best to alternate tiles taken from various boxes to ensure uniform variability of laid product.

When laying rows of tiles, it is technically advisable to offset the joints, as long as they overlap ¼ of the adjoining piece. Offset by overlapping ½ of the adjoining piece is unadvised. If the product has an irregular pattern, lay at random, i.e. the pattern must be laid in different directions.

The use of levelling systems that avoid unevenness in the tiles applied to both floors and walls, especially for 30x30cm size tiles and larger, is advised. Always apply adhesive to both surfaces.

THE JOINTS

To prevent ceramic tiles from detaching, it is advisable to leave a space for grout between the tiles. There are several types of grout spacing:

a) Placing joint: Regular space between two tiles.

Minimum recommended space:

- NAT, MATT NAT finish: 4mm
- RECT, MATT RECT, SOFT, LAP, POL, SILK, SOFT GRIP finish: 2mm
- Exterior linings: 5mm
- Underfloor heating: 4mm

Grouting should be applied diagonally in relation to the joints.

b) Fraction joints: Subdivide panelling into smaller areas to release tension. Recommended in areas with the following dimensions:

- Floors:
- Indoor: over 32 m², or when one of the sides is more than 8 meters long.
 - Outdoor: over 25 m², or when one of the sides is more than 5 meters long.

Walls:

- Indoor: over 32 m², or when one of the sides is more than 8 meters long.
- Outdoor: a horizontal expansion joint should be inserted every 3 meters, and a vertical one every 5 meters.

c) Perimeter or corner joint: Helps to finish off a plane, for use where wall and floor join, or at wall corners.

d) Structural joint: Regular space between two structures, as per design. Under no circumstances must these joints be filled with any sort of material.

Where bright or dark colour grout is used, experiment first on some extra tiles. In this case, a primary coating should be applied for protection of the ceramic pieces. Apply protection on textured or structured tiles before joining.

Joint cleaning

Joints with bright or dark colour grout require a considerable amount of cleaning during laying of the tiles.

To prevent or clean fungi that cause the tile joints to darken, apply anti-fungal cement and let it dry completely. Then apply a hydrophobic agent (to keep humidity out) or any other water-based seal.

Maintenance requires the reapplication of this seal every 4 years.

Clean the joints when the mortar in the joints begins to set. Avoid using excess water, as too much water will cause pigment dispersion and discolouration of the joints.

After 24 hours, clean the surface with a dry or damp cloth. To ensure high humidity resistance, 2 to 3 weeks after grouting apply waterproof seal.

THE ADHESIVE

To ensure adequate bonding, use a cement-based adhesive and apply to both surfaces, i.e. on the subsurface and reverse side of tile (see table on page 387).

When laying the tiles, place them slightly to one side and gently slide them into place with your fingers. To tap the tiles and ensure that the adhesive cords have been crushed properly, use a white rubber mallet. Do not use black rubber mallets, which may leave marks.

After all of the tiles have been laid, remove all excess adhesive from the tiles before it sets and makes final clean up more difficult.

When laying large format tiles, use levelling spacers to ensure proper installing and levelling of tiles. Use the plastic spacers after the adhesive has been applied.

CUTTING/HOLES

Cutting/making holes depends on the type of tiles.

In the particular case of porcelain tiles, which have low water-resistance and high mechanical strength, use a diamond disc / drill bit. (see table on page 388)

AFTER THE LAYING

PROTECTION

After the porcelain tiles have been laid and before the whole project is complete, we recommend protecting the entire surface from damage caused by the movement of people and/or materials belonging to the works.

CLEANING

At the end of the project, clean tiles with the appropriate chemicals for removing existing residues. Follow the use instructions of the cleaning products and make sure they do not contain hydrofluoric acid. We recommend you test the products previously on an extra tile.

It is crucial that you rinse the tiles several times to remove all residues and chemical products.

The waterproof seal used on the surface of polished tiles should be removed to restore the original shine of the tiles. Use a sponge and suitable detergent, alcohol or cellulose thinner.

Light-coloured tiles, namely with non-slip characteristics, undergo more frequent deep cleaning.

MAINTENANCE

Maintaining and cleaning ceramic tiles is very practical and easy. For daily cleaning, use water (preferably warm) and a neutral detergent. We recommend you use only very small amounts of detergent, which can be removed completely after cleaning.

Use a hard brush on tiles with rustic and anti-slip finish to remove all grit in between the cracks.

We recommend you place mats in busy areas to preserve tiles from wear, especially in areas with traffic from the exterior, to prevent bringing in sand, which is damaging to any type of floor.

On decorative tile, especially on glass and/or gold or platinum metallic surfaces, do not use tools or acid and/or abrasive cleaning products, which may damage the decorative surface.

For more detailed information, see: **Technical Manual - Best Tile-laying Practices**



AVANT LA POSE

LE MATÉRIAU

Se certifier que le matériau est suffisant pour la réalisation de tout l'ouvrage et que toutes les boîtes ont la même Qualité, Tonalité et Calibre. Si vous souhaitez combiner différents produits, vous devrez utiliser des matériaux avec des bords rectifiés et des produits de même calibre.

LE SUPPORT

Vérifier que le support ne présente aucune irrégularité de planéité supérieure à 5mm. Sinon, il faudra procéder à son nivellement.

DURANT LA POSE

LE CARRELAGE

On recommande l'utilisation, alternée, de carreaux provenant de boîtes différentes de manière à uniformiser la variabilité du produit posé. Techniquement, la pose à joints croisés à ¼ de la pièce est recommandée. La pose à joints croisés à ½ de la pièce n'est pas recommandée. Si le produit a un motif irrégulier, sa pose doit être aléatoire, c'est-à-dire que le motif doit être appliqué dans différentes directions.

Il est conseillé d'utiliser des systèmes de nivellement qui empêchent la formation d'irrégularités lors de la pose du carrelage, aussi bien au sol que sur les murs, notamment, dans les formats 30x30 cm et supérieurs. Utiliser toujours le double encollage.

LES JOINTS

Afin de prévenir le décolllement potentiel du matériau céramique, il est conseillé d'appliquer le produit avec des joints. Il existe plusieurs types de joints:

a) Joint de pose : espace régulier laissé entre deux pièces.

Joints minimum recommandés:

- Finition NAT, MATT NAT : 4mm
- Finition RECT, MATT RECT, SOFT, LAP, POL, SILK, SOFT GRIP : 2mm
- Revêtements extérieurs : 5mm
- Sols chauffants: 4mm

Le remplissage des joints de pose doit être effectué en diagonale par rapport aux joints.

b) Joint de fractionnement : subdivise le revêtement en surfaces plus petites, atténuant les tensions générées. Il est recommandé de l'utiliser dans les surfaces avec les dimensions suivantes:

Sols :

- Intérieur : à partir de 32 m², ou lorsque l'un des côtés est supérieur à 8 mètres continus.
- Extérieur : à partir de 25 m², ou lorsque l'un des côtés est supérieur à 5 mètres continus.

Murs :

- Intérieurs : à partir de 32 m², ou lorsque l'un des côtés est supérieur à 8 mètres.
- Extérieurs: un fractionnement à l'horizontale doit être effectué tous les 3 mètres et à la verticale tous les 5 mètres.

c) Joint périphérique ou de coin : se trouve dans le changement des plans, tant dans la jonction entre les murs et les sols, que dans les angles des murs.

d) Joint structurel : espace régulier entre deux structures, prévu dans le projet. Son espace ne doit, en aucun cas, être rempli d'un quelconque matériau.

En cas d'utilisation de joints très colorés ou foncés, faire un test au préalable avec des pièces de réserve afin d'en vérifier le comportement. Dans ce cas, il est recommandé d'appliquer un primaire de protection sur les pièces.

Lors de l'application de matériaux à surface rugueuse ou structurée, un protecteur doit être appliqué avant le jointolement.

Nettoyage des joints

Les joints à coloration forte ou foncée exigent un nettoyage plus soigneux et plus fréquent durant la pose. Pour prévenir ou nettoyer les champignons qui assombrissent les joints céramiques, un mortier à action antifongique doit être utilisé lors de la pose et un agent hydrofuge (qui repousse l'humidité) ou tout autre type de base aqueuse doit être appliqué après le séchage.

L'entretien doit être effectué tous les 4 ans en procédant au renouvellement de l'application de ce produit. Les joints doivent être nettoyés lorsque le mortier commence à durcir. Ne pas utiliser trop d'eau lors du nettoyage car cela provoque une dispersion des pigments et une décoloration précoce du joint.

Après 24 heures, un nettoyage général doit être effectué avec un chiffon sec ou humide. Pour assurer une plus grande résistance du joint à l'humidité, il faut l'hydrofuger dans les 2 ou 3 semaines après le jointolement.

LA COLLE

Pour obtenir une bonne adhérence, il faut utiliser une colle-ciment appropriée et procéder toujours à un double encollage, c'est-à-dire, étaler la colle sur le support et le dos du carreau (voir le tableau à la page 387).

Lors de la pose des pièces, placez-les légèrement éloignées de leur position et faites-les glisser jusqu'à leur position finale en faisant un léger mouvement avec les doigts. Pour tapoter le matériau et s'assurer que les cordons de colle sont bien écrasés, nous recommandons l'utilisation d'un maillet en caoutchouc blanc.

N'utilisez pas de maillets en caoutchouc noir car ils pourraient laisser des traces.

À la fin de la pose, effectuer un nettoyage général pour éliminer toute trace de colle résiduelle sur les pièces, en évitant qu'elle durcisse et rende, ultérieurement, difficile le nettoyage final.

Pour la pose de pièces de grand format, nous suggérons l'utilisation de croisillons autonivelants pour aider à positionner et à niveler le joint entre les pièces. Ces accessoires en plastique doivent être utilisés après l'application de la colle.

COUPES/ TROUS

Les coupes / trous du matériau dépendent de la typologie du produit. Dans le cas particulier des carreaux porcelanato, qui se caractérisent par leur faible absorption d'eau et leur résistance mécanique élevée, un disque / foret diamant doit être utilisé. (voir le tableau à la page 388)

APRÈS LA POSE

PROTECTION

Après la pose du matériau céramique et avant la fin de l'ouvrage, il est recommandé de protéger correctement tout le revêtement sol, afin d'éviter que la surface ne soit endommagée par la circulation de personnes et / ou de matériaux utilisés sur le chantier.

NETTOYAGE

À la fin des travaux, le matériau doit être nettoyé en vue d'éliminer tout type de saleté, avec des produits chimiques adaptés aux types de résidus existants. Il est important de respecter les consignes d'emploi de ces produits et d'être absolument certain qu'ils ne contiennent pas d'acide fluorhydrique. Nous recommandons que ces produits soient préalablement testés sur une pièce de réserve.

Il est fondamental que tous les résidus et produits chimiques utilisés soient complètement éliminés à l'aide de plusieurs rinçages à l'eau propre.

Dans le cas d'un matériau poli, la couche superficielle d'imperméabilisation doit être enlevée afin de lui restituer sa brillance d'origine. Pour ce faire, il est recommandé de l'enlever avec une éponge en utilisant un détergent approprié, alcool ou diluant cellulosique.

Les produits de couleurs claires ayant, notamment, des caractéristiques antidérapantes, sont sujets à un nettoyage plus exigeant et plus fréquent.

ENTRETIEN

L'entretien et le nettoyage des produits céramiques est facile et pratique. Pour le nettoyage quotidien, utiliser de l'eau (de préférence tiède) et un détergent neutre. Il est recommandé d'utiliser de très petites quantités de détergent, de sorte qu'il puisse être complètement retiré après le nettoyage.

Dans les finitions rustiques et antidérapantes, il convient d'utiliser une brosse en fibre dure, pour enlever la saleté qui s'accumule sur la surface rugueuse.

Pour une bonne conservation du produit, nous recommandons la mise en place de tapis dans les zones à fort trafic/ circulation, notamment dans les espaces de communication avec l'extérieur, afin d'éviter la circulation de sable, nuisible à tout type de sol.

Pour le carrelage décor, en particulier les produits en verre et / ou métallisés or ou platine, des ustensiles ou des produits de nettoyage acides et/ou abrasifs ne doivent pas être utilisés car ils peuvent endommager la décoration.

Pour des informations plus détaillées, consultez : **Manuel Technique**



ASENTAMIENTO Y MANTENIMIENTO

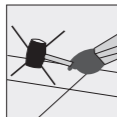
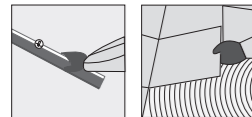

ANTES DE LA COLOCACIÓN

EL MATERIAL

Confirmar la existencia de material suficiente para llevar a cabo toda la obra y si todas las cajas pertenecen a la misma calidad, tonalidad y calibre. En caso de querer combinar productos diferentes, emplear materiales con las aristas rectificadas y productos con el mismo calibre.

LA SUPERFICIE DE APLICACIÓN

Comprobar que la superficie de aplicación no presenta irregularidades de planimetría superiores a 5 mm. En caso contrario, es necesario nivelar.

DURANTE LA COLOCACIÓN

EL MATERIAL

Se aconseja alternar mosaicos pertenecientes a varias cajas con el fin de uniformar la variabilidad del producto colocado. Técnicamente, se recomienda aplicar los materiales a matajunta a ¼ de la pieza. No se recomienda la aplicación a matajunta a ½ de la pieza.

Si el producto tiene un patrón irregular, debe aplicarse de forma aleatoria, es decir, el patrón debe aplicarse en diferentes direcciones. Se aconseja la utilización de sistemas de nivelación que evitan la creación de desniveles durante la colocación de las baldosas, tanto en pavimentos como en revestimientos, en particular en formatos 30x30 cm y superiores. Utilizar siempre la técnica del doble encolado.

LAS JUNTAS

Con el fin de evitar el posible desencolado del material cerámico, se recomienda la aplicación del producto con juntas. Existen varios tipos de juntas:

a) Junta de colocación: espacio regular que se deja entre dos piezas.

Juntas mínimas recomendadas:

- Acabado NAT, MATT NAT: 4mm
- Acabado RECT, MATT RECT, SOFT, LAP, POL, SILK, SOFT GRIP: 2mm
- Revestimientos exteriores: 5mm
- Suelo radiante: 4mm

Rellenar las juntas de colocación en diagonal con respecto a las juntas.

b) Junta de fraccionamiento: subdivide el revestimiento en superficies más pequeñas aliviando las tensiones generadas. Se recomienda su uso en superficies con las siguientes dimensiones:

Pavimentos:

- Interiores: a partir de 32 m² o cuando uno de los dos lados es superior a 8 metros continuos.
- Exteriores: a partir de 25 m² o cuando uno de los dos lados es superior a 5 metros continuos.

Revestimientos:

- Interiores: a partir de 32 m² o cuando uno de los lados es superior a 8 metros.
- Exteriores: realizar una división horizontal cada 3 metros y vertical cada 5 metros.

c) Junta perimetral o de esquina: se encuentra en el cambio de planos, tanto en el encuentro entre paredes y pavimentos, como en las esquinas de paredes.

d) Junta estructural: espacio regular entre dos estructuras, previsto en el proyecto. Su espacio no debe rellenarse con ningún material bajo ninguna circunstancia.

Cuando se empleen juntas de color fuerte u oscuro, realizar una prueba previa en piezas sobrantes para comprobar su comportamiento. En tal caso, se recomienda aplicar una imprimación de protección a las piezas.

Al aplicar materiales con superficie rugosa o estructurada, aplicar un protector antes de rejuntrar.

Limpieza de las juntas

Las juntas de color fuerte u oscuro requieren una limpieza más cuidadosa y habitual durante la colocación.

Para prevenir o limpiar los hongos que oscurecen las juntas cerámicas, emplear una lechada con acción antifúngica durante la aplicación y, una vez seca, aplicar un agente hidrófugo (que repele la humedad) o cualquier otro tipo de base acuosa.

Cada 4 años, realizar un mantenimiento en el que se renovará la aplicación de este producto. Limpiar las juntas cuando el mortero de juntas comience a endurecerse. No utilizar demasiada agua en la limpieza, ya que provoca la dispersión del pigmento y la decoloración precoz de la junta.

Pasadas 24 horas, proceder a una limpieza general empleando un paño seco o húmedo. Para garantizar una mayor resistencia de la junta a la humedad, impermeabilizar transcurridas 2 o 3 semanas tras el sellado.

PEGAMENTO

Para conseguir una buena adherencia, es necesario utilizar un cemento adhesivo adecuado y emplear siempre la técnica del doble pegado, es decir, repartir el pegamento sobre el soporte y el trasdós (parte de atrás) de la pieza (ver cuadro página 387).

Al colocar las piezas, ponerlas ligeramente alejadas de su sitio y arrastrarlas hasta su posición final haciendo un leve movimiento de dedos. Para golpear el material y garantizar que los cordones del pegamento quedan bien aplastados, aconsejamos utilizar martillos de goma blanca. No utilizar martillos de goma negra, ya que pueden dejar marcas.

Al final de la aplicación, hacer una limpieza general para retirar los restos de pegamento que hayan quedado sobre las piezas, así se evita que se endurezcan y posteriormente dificulte la limpieza final.

Para la colocación de piezas de gran tamaño, sugerimos utilizar niveladores para ayudar a colocar y nivelar la junta entre piezas. Estos accesorios plásticos deben utilizarse una vez aplicado el pegamento.

CORTE/PERFORACIONES

La realización de cortes y perforaciones en el material depende del tipo de producto.

En el caso particular del porcelanato, que se caracteriza por su baja absorción de agua y su elevada resistencia mecánica, utilizar un disco o una broca de diamante (ver cuadro página 388).

DESPUÉS DE LA COLOCACIÓN

PROTECCIÓN

Tras la colocación del material cerámico y antes de la conclusión de la obra, se recomienda proteger todo el pavimento adecuadamente, con el fin de evitar daños en la superficie debido al movimiento de personas o materiales relacionados con los trabajos.

LIMPIEZA

Al finalizar la obra, eliminar toda la suciedad del material con productos químicos adecuados para los tipos de restos existentes. Es importante respetar las instrucciones de aplicación de estos productos y tener la absoluta certeza de que estos no contienen ácido fluorhídrico. Recomendamos realizar una prueba previa de estos productos en una pieza sobrante.

Es fundamental eliminar todos los restos y productos químicos utilizados, enjuagando varias veces con agua limpia.

En el caso de material pulido, eliminar la capa superficial de impermeabilizante, para devolver el brillo original del material. Se recomienda eliminarla con una esponja impregnada en un detergente adecuado, alcohol o diluyente celulósico.

Los productos de color claro, especialmente aquellos con propiedades antideslizantes, pueden requerir una limpieza más exhaustiva y frecuente.

MANTENIMIENTO

El mantenimiento y la limpieza de los productos cerámicos son muy prácticos y fáciles. Para la limpieza diaria, emplear agua (preferiblemente templada) y detergente neutro. Se recomienda utilizar cantidades muy pequeñas de detergente, para poder eliminarlo por completo tras la limpieza.

En los acabados rústicos y antideslizantes, es conveniente utilizar un cepillo de fibra dura para eliminar la suciedad que se acumula en la superficie rugosa.

Para una buena conservación del producto, recomendamos la colocación de alfombras en las zonas de mayor paso/tráfico, en particular en las zonas de comunicación con el exterior, para evitar la circulación de arenas, perjudiciales para cualquier tipo de pavimento.

Con respecto a las decoraciones, especialmente en los productos de vidrio o metalizados en oro o platino, no se deben utilizar utensilios ni productos ácidos o abrasivos, ya que podrían dañar la decoración.

Para obtener información más detallada, consulte: **Manual Técnico - Buenas Prácticas de Colocación**



ASSENTAMENTO E MANUTENÇÃO

TILE LAYING AND MAINTENANCE _ POSE ET ENTRETIEN ASENTAMIENTO Y MANTENIMIENTO

UTILIZE UM CIMENTO-COLA ADEQUADO:

USE A CEMENT-BASED ADHESIVE:

UTILISEZ UNE COLLE-CIMENT APPROPRIÉE:

UTILICE UN CEMENTO ADHESIVO ADECUADO:

PRODUTO PRODUCT PRODUIT PRODUCTO	FORMATO SIZE FORMAT FORMATO (CM)	REVESTIMIENTO INTERIOR INDOOR WALLS REVÊTEMENT DE MUR INTÉRIEUR REVESTIMIENTO INTERIOR						
		Reboco e Betão Plaster and concrete Plâtre et béton Enlucido y hormigón	Cerâmica ou Pedra Ceramics or stone Céramique ou pierre Cerámica o piedra	Gesso ou Gesso Cartonado Plaster or plasterboard Plâtre ou plaque de plâtre Yeso o yeso laminado	Impermeabilizações Waterproofing Étanchéité Impermeabilización	Placas Compositas de Cimento Composite cement boards Panneaux de ciment composite Placas de cemento compuesto	Madeira Wood Bois Madera	Metal Metal Métal Metal
	20x20	webercol flex XS*	webercol flex lev / webercol flex M*	webercol flex S*	webercol flex lev / webercol flex M*	webercol flex lev / webercol flex M*	webercol flex lev / webercol flex M*	webercol flex lev / webercol flex M*
	20x40							
	30x45							
	30x60							
30x90	webercol flex S*		webercol flex lev / webercol flex M*					

PRODUTO PRODUCT PRODUIT PRODUCTO	FORMATO SIZE FORMAT FORMATO (CM)	REVESTIMIENTO EXTERIOR OUTDOOR WALLS REVÊTEMENT DE MUR EXTÉRIEUR REVESTIMIENTO EXTERIOR (* < 6 M)		FACHADAS FAÇADES FAÇADE FACHADAS	
		Reboco Plaster Plâtre Enlucido	ITE - Isolamento térmico pelo exterior Webertherm keramic plus ETI - Exterior thermal insulation Webertherm keramic plus	Reboco Plaster Plâtre Enlucido	ITE - Isolamento térmico pelo exterior Webertherm keramic plus ETI - Exterior thermal insulation Webertherm keramic plus
	30x30	webercol flex lev / webercol flex M+	webercol flex L+	webercol flex L+	webercol flex L+
	30x60				
	45x45	webercol flex L+	webercol flex XL+	webercol flex XL+	webercol flex XL+
60x60	webercol flex XL+				

ITE - Isolamento térmico pelo exterior Webertherm keramic plus

ETI - Exterior thermal insulation Webertherm keramic plus

PRODUTO PRODUCT PRODUIT PRODUCTO	FORMATO SIZE FORMAT FORMATO (CM)	PAVIMENTO INTERIOR INDOOR FLOORS REVÊTEMENT DE SOL INTÉRIEUR PAVIMENTO INTERIOR								PAVIMENTO EXTERIOR OUTDOOR FLOORS REVÊTEMENT DE SOL EXTÉRIEUR PAVIMENTO EXTERIOR		
		Betonilha ou Betão Screed or concrete Chape ou béton Mortero u hormigón	Cerâmica ou Pedra Ceramics or stone Céramique ou pierre Cerámica o piedra	Impermeabilizações Waterproofing Étanchéité Impermeabilización	Pavimentos Acuécidos Heating Floors Sols Chauffants Suelos Recalentados	Sistemas acústicos Acoustic systems Systèmes acoustiques Sistemas acústicos	Placas Compositas de Cimento Composite cement boards Panneaux de ciment composite Placas de cemento composite	Madeira Wood Bois Madera	Metal Metal Métal Metal	Betonilha ou Betão Screed or concrete Chape ou béton Mortero u hormigón	Cerâmica ou Pedra Ceramics or stone Céramique ou pierre Cerámica o piedra	Impermeabilizações Waterproofing Étanchéité Impermeabilización
	30x30	webercol flex XS+	webercol flex lev / webercol flex M+	webercol flex lev / webercol flex M+	webercol flex lev / webercol flex M+	webercol flex lev / webercol flex M+	webercol flex lev / webercol flex M+	webercol flex lev / webercol flex M+	webercol flex lev / webercol flex M+	webercol flex XS+	webercol flex L+	webercol flex lev / webercol flex M+
	30x60											
	45x45	webercol flex S+	webercol flex L+	webercol flex XL+	webercol flex XL+	webercol flex XL+	webercol flex XL+	webercol flex XL+	webercol flex XL+	webercol flex XL+	webercol flex XL+	webercol flex XL+
	60x60											
	60x120	webercol flex lev / webercol flex M+	webercol flex XL+	webercol flex XL+	webercol flex XL+	webercol flex XL+	webercol flex XL+	webercol flex XL+	webercol flex XL+	webercol flex XL+	webercol flex XL+	webercol flex XL+
	90x90	webercol flex XL+										
60x180	webercol flex XL+	webercol flex XL+	webercol flex XL+	webercol flex XL+	webercol flex XL+	webercol flex XL+	webercol flex XL+	webercol flex XL+	webercol flex XL+	webercol flex XL+	webercol flex XL+	
		webercol flex XL+	webercol flex XL+	webercol flex XL+	webercol flex XL+	webercol flex XL+	webercol flex XL+	webercol flex XL+	webercol flex XL+	webercol flex XL+	webercol flex XL+	

Os produtos das empresas referidas são meramente exemplificativos. Além destas, existem diversas empresas que dispõem de produtos similares e de qualidade.

The products of the referred companies are merely indicated as an example. There is a number of other companies that supply quality products for this purpose.

Les produits des sociétés citées ne sont donnés qu'à titre d'exemple. D'autres sociétés commercialisent également des produits de qualité.

Los productos de las empresas indicadas son meramente ejemplares. Además de estas, existen diversas empresas que disponen de productos similares y de calidad.

ASSENTAMENTO E MANUTENÇÃO

TILE LAYING AND MAINTENANCE _ POSE ET ENTRETIEN

ASENTAMIENTO Y MANTENIMIENTO



CORTE / FUROS DO GRÉS PORCELÂNICO:



PORCELAIN TILES CUTTING/ HOLES:



COUPES / TROUS DE GRÉS CÉRAMÉ:



CORTE /PERFORACIONES DEL GRES PORCELÁNICO:



	CORTADOR MANUAL MANUAL CUTTER COUPEUSE MANUELLE CORTADOR MANUAL	
	TS-43, 57, 66 e 75 MAX	
	TR- 600 e 710 MAGNET	
	TX-710; TX1020; TX1250 MAX	
	TZ - 850, 1020, 1300 e 1550	

	CORTADOR ELÉCTRICO (HÚMIDO) - RUBI ELECTRIC CUTTER (WET) - RUBI COUPEUSE ÉLECTRIQUE (HUMIDE) - RUBI CORTADOR ELÉCTRICO (HÚMEDO)- RUBI	DISCO WHEEL DISQUE DISCO
	DV-200-1000	CPC / CPX / TVH
	DC-250-850 e 1200	
	DS-250 N 1000, 1300 e 1500 LASER & LEVEL	
	DCX-250 XPERT 1250 e 1550 ZERO DUST	
	DX-350 N 1000 e 1300 LASER & LEVEL	

	CORTADOR ELÉCTRICO (SECO) ELECTRIC CUTTER (DRY) COUPEUSE ÉLECTRIQUE (SÈCHE) CORTADOR ELÉCTRICO (SECO)	DISCO WHEEL DISQUE DISCO
	TC-125	TVA / VIPER / CPR / CPJ / TCR / TVR / ECD
	KIT-TC125	

	BROCA DIAMANTE - CORTE HÚMIDO - RUBI DIAMOND DRILL - WET CUTTING - RUBI DIAMOND DRILL - COUPE HUMIDE - RUBI BROCA DIAMANTE - CORTE HÚMEDO - RUBI	MEDIDAS SIZES DIMENSIONS DIMENSIONES
	BROCAS EASY GRÉS	De Ø6 até Ø120
	Para trabalhar com berbequim com e sem fios	De Ø6 até Ø120

	BROCA DIAMANTE - CORTE SECO - RUBI DIAMOND DRILL - DRY CUTTING - RUBI DIAMOND DRILL - COUPE SÈCHE - RUBI BROCA DIAMANTE - CORTE SECO - RUBI	MEDIDAS SIZES DIMENSIONS DIMENSIONES
	BROCAS DIAMANTE DRYGRES	De Ø6 até Ø75

	BROCAS DRYGRES 4DRILL (SECO) DRILL BITS DRYGRES 4DRILL (DRY) TRÉPANS DRYGRES 4DRILL (SÈCHE) BROCA DRYGRES 4DRILL (SECO)	
	De Ø6 até Ø20	
	Para trabalhar com berbequim	
	Min. 1500 rpm	

ASSENTAMENTO E MANUTENÇÃO

TILE LAYING AND MAINTENANCE _ POSE ET ENTRETIEN

ASENTAMIENTO Y MANTENIMIENTO

Superficie Surface Superficie	Aresta Edge Arête Arista	ACABAMENTO FINISH FINITION ACABADO	PRODUTOS PRODUCTS PRODUITS PRODUCTOS	ESPESSURA THICKNESS ÉPAISSEUR ESPEJOR (MM)	CAIXA BOX PAQUET CAJA			EUROPALETE EUROPALETTE EUROPALÉ (N)			CAMIÃO 24 TON. 24 TONE TRUCK CAMION 24 T CAMION 24 TON.			CONTENTOR 20 PÉS 20' CONTAINER CONTAINER 20 PIEDS CONTENEDOR 20 PIES		
					Nº Peças No Pieces No Piezas	M2 Aprox. Approx. M2 Aprox.	Peso (Kg) Weight Kg Poids Kg (4)	Nº Caixas No Boxes No Cajas	M2 Aprox. Approx. M2 Aprox.	Peso (Kg) Weight Kg Poids Kg (5)	Nº Paletes No Pallets No Palés	M2 Aprox. Approx. M2 Aprox.	Peso (Kg) Weight Kg Poids Kg (5)	Nº Paletes No Pallets No Palés	M2 Aprox. Approx. M2 Aprox.	Peso (Kg) Weight Kg Poids Kg (5)
REVESTIMENTO CERÂMICO VIDRADO · GLAZED WALL TILES IN WHITE BODY · FAÏENCE PÂTE BLANCHE · REVESTIMIENTOS CERÁMICOS VIDRIADOS																
16,5x19 6"x7"	RECT.	Nat.	Rect.	UNICOLOR · NEUTRAL	12,3 ±0,5 mm	6	0,15	3,5	106	15,90	392	-	-	-	-	-
20x20 8"x8"	NAT.	Nat.	Normal	FAIT-DIVERS	8,1 ± 5 %	6	-	3,5	-	-	-	-	-	-	-	-
20x40 8"x16"	NAT.	Nat.	Normal	Geral · General Général · Standard	8,4 ± 5 %	10	0,80	11,5	96	76,80	1 120	21	1 613	23 524	22	1 690 24 644
	NAT.	Nat.	Normal	RETRO	9,0 ± 5 %	9	0,72	10,4	96	69,12	1 019	23	1 590	25 446	22	1 521 22 427
30x45 12"x18"	NAT.	Nat.	Normal	Geral · General Général · Standard	9,0 ± 5 %	11	1,50	23,9	48	72,00	1 166	20	1 440	23 316	21	1 512 24 482
	NAT.	Nat.	Normal	Geral · General Général · Standard	9,0 ± 5 %	8	1,44	24,0	32	46,08	789	30	1 382	23 670	28	1 290 22 092
30x60 12"x24"	RECT.	Nat.	Rect.	Geral · General Général · Standard	9,0 ± 5 %	8	1,40	23,2	32	44,80	763	31	1 389	23 665	28	1 254 21 375
30x90 12"x35"	RECT.	Nat.	Rect.	Geral · General Général · Standard	12,3 ±0,5 mm	4	1,05	22,0	40	42,00	901	26	1 092	23 426	28	1176 25 228
40x120 16"x47"	RECT.	Nat.	Rect.	Geral · General Général · Standard	12,3 ±0,5 mm	3	1,40	29,0	18	25,20	543	33	832	17 919	28	706 15 204
GRÉS PORCELÂNICO ESMALTADO · GLAZED PORCELAIN TILES · GRÉS PORCELAINÉ ÉMAILLÉ · GRÉS PORCELÁNICO ESMALTADO																
7x29 3"x11"	NAT.	Nat.	Normal	BRICK	8,5 ± 5 %	40	0,85	16,07	30	25,50	502,95	-	-	-	-	-
14x14 6"x6"	NAT.	Nat.	Normal	BLOCK	8,5 ± 5 %	40	0,84	15,88	30	20,20	476,4	-	-	-	-	-
15x75 6"x30"	NAT.	Nat.	Normal	Geral · General Général · Standard	8,5 ± 5 %	8	0,90	17,5	64	57,60	1 141	21	1 210	23 961	22	1 267 25 102
	NAT.	Nat.	Normal	Geral · General Général · Standard	8,1 ± 5 %	16	1,44	27,2	48	69,12	1 327	18	1 244	23 879	19	1 313 25 205
30x30 12"x12"	RECT.	Nat.	Rect.	Geral · General Général · Standard	8,1 ± 5 %	16	1,39	27,2	48	66,72	1 327	18	1 201	23 879	19	1 268 25 205
	NAT.	Nat.	Normal	Geral · General Général · Standard	8,5 ± 5 %	8	1,44	27,0	32	46,08	885	26	1 198	23 010	26	1 198 23 010
30x60 12"x24"	RECT. MATT RECT.	Nat.	Rect.	MARBLES	9,8 ± 5 %	8	1,40	33,2	32	44,80	1 083	22	986	23 835	24	1 075 26 002
	POL.	Pol.	Rect.	MARBLES	9,8 ± 5 %	8	1,40	33,2	32	44,80	1 083	22	986	23 835	24	1 075 26 002
50x58 19"x22"	MATT RECT.	Nat.	Rect.	MARBLES	9,8 ± 5 %	4	0,88	20,2	32	28,16	667	-	-	-	-	-
	POL.	Pol.	Rect.	MARBLES	9,8 ± 5 %	4	0,88	20,2	32	28,16	667	-	-	-	-	-
60x60 24"x24"	RECT. MATT RECT.	Nat.	Rect.	MARBLES	9,8 ± 5 %	4	1,40	33,0	32	44,80	1 077	22	986	23 694	25	1 120 26 925
	POL.	Pol.	Rect.	MARBLES	9,8 ± 5 %	4	1,40	33,0	32	44,80	1 077	22	986	23 694	25	1 120 26 925
60 x 120 24" x 47"	RECT. MATT RECT	Nat.	Rect.	MARBLES	9,8 ± 5 %	2	1,40	33,0	30	42,00	1 011	23	966	23 253	25	1 050 25 275
	POL.	Pol.	Rect.	MARBLES	9,8 ± 5 %	2	1,40	33,0	27	37,80	912	25	945	22 800	26	983 23 712
45x45 18"x18"	NAT.	Nat.	Normal	Geral · General Général · Standard	8,2 ± 5 %	6	1,22	24,0	34	41,48	837	28	1 161	23 436	30	1 244 25 110
20 x 90 8" x 35"	MATT NAT.	Nat.	Normal	MONTANA	10,5 ±0,5 mm	6	1,08	26,2	36	38,88	964	23	894	22 177	26	1 011 25 069
	MATT NAT.	Nat.	Normal	CHEVRON MONTANA	10,5 ±0,5 mm	6	0,82	21,9	36	29,52	809	28	827	22 663	32	945 25 901
90 x 90 35" x 35"	MATT RECT.	Nat.	Rect.	MARBLES	10,5 ±0,5 mm	2	1,58	38,0	24	37,92	967	23	872	22 241	26	986 25 142
	POL.	Pol.	Rect.	MARBLES	10,5 ±0,5 mm	2	1,58	38,0	24	37,92	967	23	872	22 241	26	986 25 142
4,5 x 90 18" x 35"	MATT RECT.	Nat.	Rect.	MARBLES	10,5 ±0,5 mm	4	1,58	38,0	24	37,92	967	23	872	22 241	26	986 25 142
	POL.	Pol.	Rect.	MARBLES	10,5 ±0,5 mm	4	1,58	38,0	24	37,92	967	23	872	22 241	26	986 25 142
120 x 120 47" x 47"	MATT RECT.	Nat.	Rect.	MARBLES	9,0 ±5%	1	1,44	28,10	32	46,08	959,20	-	-	-	-	-
	POL.	Pol.	Rect.	MARBLES	9,0 ±5%	1	1,44	28,10	32	46,08	959,20	-	-	-	-	-
120 x 278 47" x 109"	MATT RECT.	Nat.	Rect.	MARBLES	6,0 ±5%	1	3,33	50,40	18	59,94	1019	-	-	-	-	-
	POL.	Pol.	Rect.	MARBLES	6,0 ±5%	1	3,33	50,40	18	59,94	1019	-	-	-	-	-

1 inch = 2,54 cm.

- (4) O peso de uma caixa pode ter uma variação de ± 2%.
The weight of one box can have a variation of ± 2%.
Le poids d'un paquet peut varier de ± 2 %.
El peso de una caja puede tener una variación de ± el 2%.
- (5) O peso de uma Europaleta é de aproximadamente 21 Kg e está incluído nos valores indicados no quadro.
The weight of one Europallet is approximately 21 Kg and are included in the values mentioned in the table.
Une Europalette pèse environ 21 kg et est inclus dans les valeurs indiquées dans le tableau.
El peso de un Europalé es de aproximadamente 21 Kg y está incluido en los valores indicados en el cuadro.

Os valores das dimensões e pesos são aproximados.
Size and weight values are approximate.
Les valeurs des dimensions et du poids sont approximatives.
Los valores de las dimensiones y pesos son aproximados.

Os produtos das empresas referidas são meramente exemplificativos. Além destas, existem diversas empresas que dispõem de produtos similares e de qualidade.
The products of the referred companies are merely indicated as an example. There is a number of other companies that supply quality products for this purpose.
Les produits des sociétés citées ne sont donnés qu'à titre d'exemple. D'autres sociétés commercialisent également des produits de qualité.
Los productos de las empresas indicadas son meramente ejemplares. Además de estas, existen diversas empresas que disponen de productos similares y de calidad.

EMBALAGENS E PESOS

PACKING LIST AND WEIGHTS - EMBALLAGES ET POIDS - EMBALAJES Y PESOS

		ACABAMENTO FINISH FINITION ACABADO		PRODUTOS PRODUCTS PRODUITS PRODUCTOS		ESPESSURA THICKNESS ÉPAISSEUR ESPESOR (MM)		CAIXA BOX PAQUET CAJA			EUROPALETE EUROPALLET EUROPALETTE EUROPALÉ (N)			CAMIÃO 24 TON. 24 TONE TRUCK CAMION 24 T CAMIÓN 24 TON.			CONTENTOR 20 PÉS 20' CONTAINER CONTAINER 20 PIEDS CONTENEDOR 20 PIES			
		Superfície Surface Superficie	Aresta Edge Arête Arista	GRÊS PORCELÂNICO TÉCNICO · FULL BODY PORCELAIN TILES · GRÈS PORCELAINÉ PLEINE MASSE · GRÉS PORCELÁNICO TÉCNICO		Nº Peças No Pieces Nº Piezas	M2 Aprox. No of Sq. M. Approx.	Peso (Kg) Weight Kg Poids Kg (4)	Nº Caixas No Boxes Nº Cajas	M2 Aprox. No of Sq. M. Approx.	Peso (Kg) Weight Kg Poids Kg (5)	Nº Paletes No Pallets Nº Palés	M2 Aprox. No of Sq. M. Approx.	Peso (Kg) Weight Kg Poids Kg (5)	Nº Paletes No Pallets Nº Palés	M2 Aprox. No of Sq. M. Approx.	Peso (Kg) Weight Kg Poids Kg (5)	Nº Paletes No Pallets Nº Palés	M2 Aprox. No of Sq. M. Approx.	Peso (Kg) Weight Kg Poids Kg (5)
10 x 10 4" x 4"	Matt Rect Soft.	Nat.	Rect.	CROMÁTICA	8,5 ±5%	32	0,30	5,8	180	54,00	1065	22	1 188	23 430	23	1 242	24 495			
15x 15 6" x 6"	Matt Rect.	Nat.	Rect.	SLATE	8,5 ±5%	22	0,47	10,0	112	52,64	1141	21	1 105	23 961	22	1 158	25 102			
16,5 x 19 6" x 7"	Rect. Soft.	Nat.	Rect.	GERAL • GENERAL GÉNÉRAL • GENERAL	8,5 ±5%	6	0,15	3,50	106	15,90	392	-	-	-	-	-	-			
25 x 29 10" x 11"	Rect.	Nat.	Rect.	DI ALBA STONE	8,5 ±5%	12	0,67	15,0	30	20,02	471	-	-	-	-	-	-			
30 x 30 12" x 12"	Nat. Matt	Nat.	Normal (1)	GERAL • GENERAL GÉNÉRAL • GENERAL	7,7 ±5%	16	1,44	28,0	40	57,60	1141	21	1 210	23 961	24	1 382	27 384			
	Nat.	Nat.	Normal	ANTISLIP PIGMENTOS, PIGMENTOS, SATURNO	7,0 ±5%	16	1,44	24,0	48	69,12	1173	20	1 382	23 460	22	1 521	25 806			
	Rect. Matt Soft.	Nat.	Rect.	GERAL • GENERAL GÉNÉRAL • GENERAL	7,7 ±5%	16	1,39	28,0	40	55,60	1141	21	1 168	23 961	24	1 334	27 384			
	Pol.	Pol.	Rect.	CORTE DA PEÇA • CUT FROM • PIECE COUPE DU CARREAU - 30x60	8,5 ±5%	16	1,39	28,8	40	55,60	1173	20	1 112	23 460	22	1 223	25 806			
	Rect. Matt Soft.	Nat.	Rect.	CROSS • LINEA • SQUARE	8,5 ±5%	11	1,00	16,5	45	45,00	764	31	1 395	23 669	11	495	8 399			
	Pol.	Pol.	Rect.	GERAL • GENERAL GÉNÉRAL • GENERAL	8,0 ±5%	16	1,39	25,6	40	55,60	1045	22	1 223	22 990	26	1 446	27 170			
30 x 60 12" x 24"	Nat.	Nat.	Normal (1)	GERAL • GENERAL GÉNÉRAL • GENERAL	8,5 ±5%	8	1,44	28,8	32	46,08	943	25	1 152	23 565	26	1 198	24 508			
	Rect. Matt Soft.	Nat.	Rect.	GERAL • GENERAL GÉNÉRAL • GENERAL	8,5 ±5%	8	1,40	28,8	32	44,80	943	25	1 120	23 565	26	1 165	24 508			
	Pol.	Pol.	Rect.	OMNI • OMNISTONE	9,8 ±5%	8	1,40	33,0	32	44,80	1077	22	986	23 694	25	1 120	26 925			
	Rect. Matt Soft.	Nat.	Rect.	LINEA	8,5 ±5%	7	1,25	26,5	24	30,00	657	36	1 080	23 652	11	330	7 227			
	Pol.	Pol.	Rect.	GERAL • GENERAL GÉNÉRAL • GENERAL	8,0 ±5%	8	1,40	25,6	40	56,00	1045	22	1 232	22 990	24	1 344	25 080			
	Pol.	Pol.	Rect.	OMNI • OMNISTONE	9,3 ±5%	8	1,40	31,0	32	44,80	1013	23	1 030	23 299	27	1 210	27 351			
60 x 60 24" x 24"	Rect. Matt Rect. Soft.	Nat.	Rect.	GERAL • GENERAL GÉNÉRAL • GENERAL	8,5 ±5%	4	1,40	28,7	36	50,40	1053	22	1 109	23 166	24	1 210	25 272			
	Pol.	Pol.	Rect.	OMNI • OMNISTONE	9,8 ±5%	4	1,40	33,0	32	44,80	1077	22	986	23 694	25	1 120	26 925			
	Rect. Matt Rect. Soft.	Nat.	Rect.	CROMÁTICA 14 mm	14,0 ±0,5 mm	3	1,05	34,2	32	33,60	1117	21	706	23 448	22	739	24 564			
	Pol.	Pol.	Rect.	URBAN 20 mm	20,0 ±0,5 mm	2	0,72	30,96	32	23,04	990,72	-	-	-	-	-	-			
	Rect. Matt Rect. Soft.	Nat.	Rect.	GERAL • GENERAL GÉNÉRAL • GENERAL	8,0 ±5%	4	1,40	26,7	36	50,40	981	24	1 210	23 544	25	1 260	24 525			
	Pol.	Pol.	Rect.	OMNI • OMNISTONE	9,3 ±5%	4	1,40	31,0	32	44,80	1013	22	986	22 286	25	1 120	25 325			
15 x 120 6" x 47"	Rect. Matt Rect.	Nat.	Rect.	GERAL • GENERAL GÉNÉRAL • GENERAL	9,8 ±5%	8	1,39	34,7	18	25,02	646	37	926	23 887	39	976	25 178			
	Rect. Matt Rect.	Nat.	Rect.	DECK, JINKO, NORDIK	10,5 ±0,5 mm	8	1,41	34,7	16	22,56	576	37	835	21 319	39	880	22 472			
19,5 x 120 8" x 47"	Rect. Matt Rect.	Nat.	Rect.	GERAL • GENERAL GÉNÉRAL • GENERAL	9,8 ±5%	6	1,39	33,0	24	33,36	813	29	967	23 577	31	1 034	25 203			
	Rect. Matt Rect.	Nat.	Rect.	CHEVRON NORDIK	10,5 ±0,5 mm	4	0,78	18,0	16	12,48	309	34	424	10 506	34	424	10 506			
	Rect. Matt Rect.	Nat.	Rect.	JINKO, NORDIK	10,5 ±0,5 mm	6	1,41	33,0	22	31,02	747	32	993	23 904	31	962	23 157			
30 x 120 12" x 47"	Rect. Matt Rect.	Nat.	Rect.	GERAL • GENERAL GÉNÉRAL • GENERAL	9,8 ±5%	4	1,40	33,0	16	22,40	549	43	963	23 607	44	986	24 156			
	Rect. Matt Rect.	Nat.	Rect.	JINKO, NORDIK	10,5 ±0,5 mm	4	1,42	33,0	16	22,72	549	43	977	23 607	44	1 000	24 156			
60 x 120 24" x 47"	Rect. Matt Soft.	Nat.	Rect.	GERAL • GENERAL GÉNÉRAL • GENERAL	9,8 ±5%	2	1,40	33,0	30	42,00	1011	23	966	23 253	25	1 050	25 275			
	Pol.	Pol.	Rect.	LAVASTONE 20 mm	20,0 ±0,5 mm	1	0,72	31,04	36	25,92	1119,74	-	-	-	-	-	-			
	Pol.	Pol.	Rect.	GERAL • GENERAL GÉNÉRAL • GENERAL	9,3 ±5%	2	1,40	31,0	30	42,00	951	25	1 050	23 775	26	1 092	24 726			
45 x 45 18" x 18"	Nat.	Nat.	Normal (1)	Urban • HYDRAULIK	8,5 ±5%	6	1,22	24,0	34	41,48	837	28	1 161	23 436	30	1 244	25 110			
	Rect. Soft.	Nat.	Rect.	GERAL • GENERAL GÉNÉRAL • GENERAL	8,2 ±5%	6	1,18	24,0	34	40,12	837	28	1 123	23 436	30	1 204	25 110			
	Pol.	Pol.	Rect.	GERAL • GENERAL GÉNÉRAL • GENERAL	7,7 ±5%	6	1,18	21,6	34	40,12	755	31	1 244	23 417	33	1 324	24 928			
45x90 18" x 35"	Rect. Matt Soft.	Nat.	Rect.	GERAL • GENERAL GÉNÉRAL • GENERAL	10,5 ±0,5 mm	4	1,58	39,0	24	37,92	991	22	834	23 784	23	872	24 775			
	Pol.	Pol.	Rect.	GERAL • GENERAL GÉNÉRAL • GENERAL	9,8 ±5%	4	1,58	37,0	24	37,92	943	23	872	23 575	24	910	24 518			
90x90 35" x 35"	Rect. Matt Soft.	Nat.	Rect.	GERAL • GENERAL GÉNÉRAL • GENERAL	10,5 ±0,5 mm	2	1,58	39,0	24	37,92	991	24	910	23 784	25	948	24 775			
	Lap. Pol.	Lap. Pol.	Rect.	GERAL • GENERAL GÉNÉRAL • GENERAL	9,8 ±5%	2	1,58	37,0	24	37,92	943	25	948	23 575	26	986	24 518			
19,5x180 8" x 71"	Matt Rect.	Nat.	Rect.	NORDIK • RULE	11,2 ±0,5 mm	4	1,40	35,5	32	44,80	1162	20	896	23 240	14	627	16 268			
30x180 12" x 71"	Matt Rect.	Nat.	Rect.	NORDIK	11,2 ±0,5 mm	3	1,59	41,1	20	31,80	848	28	890	23 744	14	445	11 872			
30x180 12" x 71"	Matt Rect.	Nat.	Rect.	RULE	11,2 ±0,5 mm	3	1,58	41,1	20	31,60	848	28	885	23 744	14	442	11 872			
60x180 24" x 71"	Matt Rect.	Nat.	Rect.	RULE	11,2 ±0,5 mm	1	1,05	28,5	42	44,10	1222	-	-	-	-	-	-			
120 x 120 47" x 47"	Matt Rect.	Nat.	Rect.	GERAL • GENERAL GÉNÉRAL • GENERAL	9,0 ±5%	1	1,44	28,10	32	46,08	959,20	-	-	-	-	-	-			
120 x 278 47" x 109"	Matt Rect.	Nat.	Rect.	GERAL • GENERAL GÉNÉRAL • GENERAL	6,0 ±5%	1	3,33	50,40	18	59,94	1019	-	-	-	-	-	-			

EMBALAGENS E PESOS

PACKING LIST AND WEIGHTS - EMBALLAGES ET POIDS - EMBALAJES Y PESOS

						9,5 x 30 4" x 12"		8 x 60 3" x 24"		8 x 120 3" x 47"		8 x 45 3" x 18"		8 x 90 3" x 35"		10 x 30 4" x 12"		7,5 x 75 3" x 30"		9,5 x 90 3" x 35"	
		Nat. Matt Nat.	Rect. Matt Rect. Soft	Pol.	Nat. Matt Nat.	Rect. Matt Rect. Soft	Pol.	Nat. Matt Rect. Soft	Pol.	Nat. Matt Rect. Soft	Pol.	Nat. Matt Nat.	Rect. Matt Rect. Soft	Pol.	Nat. Matt Rect. Soft	Pol.	Nat.	Nat.	Nat.	Nat.	Nat.
RODAPÉ BOLEADO (RB) ROUND TOP BULLNOSE (RB) PLINTE À BORD ARRONDI (RB) RODAPIÉ REDONDEADO (RB)	Superfície - Surface Surface - Superficie	Nat.	Nat.	Pol.	Nat.	Nat.	Pol.	Nat.	Pol.	Nat.	Pol.	Nat.	Nat.	Pol.	Nat.	Pol.	Nat.	Nat.	Nat.	Nat.	Nat.
ACABAMENTO FINISH FINITION ACABADO	Aresta - Edge Arête - Arista	Normal (1)	Rect.	Rect.	Normal (1)	Rect.	Rect.	Rect.	Rect.	Rect.	Rect.	Normal (1)	Rect.	Rect.	Rect.	Rect.	Normal	Normal	Normal	Normal	Normal
ESPESSURA (MM) THICKNESS (MM) ÉPAISSEUR (MM) ESPESOR (MM)		7,7	8,5	8,0	8,5	8,5	8,0	9,8	9,3	8,2	8,2	7,7	10,5	9,8	8,0	8,5	10,5				
CAIXA BOX PAQUET CAJA	Nº Peças - No Pieces Nbre Pièces - N.º de piezas (2)	30	30	30	15	15	15	9	9	20	20	20	8	8	30	10	7				
	Peso (Kg) - Weight Kg Poids Kg - Peso Kg (4)	15	15	14,5	17	17	16	29	27	16,5	16,5	14,5	16	14,7	16	10	15				
EUROPALETE EUROPALLET EUROPALETTE EUROPALÉ	Nº Caixas - No Boxes Nbre Paquets - N.º de Cajas	32	32	32	54	54	54	20	20	35	35	35	20	20	46	96	20				
	Peso (Kg) - Weight Kg Poids Kg - Peso Kg (5)	501	501	485	939	939	885	601	561	599	599	529	341	315	757	981	321				
DEGRAU SULCADO BOLEADO (DG) CARVED ROUND TOP STEP (DG) MARCHE STRIÉE À BORD ARRONDI (DG) RANURADOS PASO BOLEADO (DG)	Superfície - Surface Surface - Superficie	Nat.	Rect. Matt Rect. Soft <td>Pol.</td> <td>Nat.</td> <td>Rect. Matt Rect. Soft <td>Pol.</td> <td>Nat.</td> <td>Rect. Matt Rect. Soft <td>Pol.</td> <td>Nat.</td> <td>Rect. Matt Rect. Soft <td>Pol.</td> <td>Nat.</td> <td>Rect. Soft <td>Pol.</td> <td>Rect. Matt Rect. Soft <td>Pol.</td> <td>Nat.</td> <td></td> <td></td> </td></td></td></td></td>	Pol.	Nat.	Rect. Matt Rect. Soft <td>Pol.</td> <td>Nat.</td> <td>Rect. Matt Rect. Soft <td>Pol.</td> <td>Nat.</td> <td>Rect. Matt Rect. Soft <td>Pol.</td> <td>Nat.</td> <td>Rect. Soft <td>Pol.</td> <td>Rect. Matt Rect. Soft <td>Pol.</td> <td>Nat.</td> <td></td> <td></td> </td></td></td></td>	Pol.	Nat.	Rect. Matt Rect. Soft <td>Pol.</td> <td>Nat.</td> <td>Rect. Matt Rect. Soft <td>Pol.</td> <td>Nat.</td> <td>Rect. Soft <td>Pol.</td> <td>Rect. Matt Rect. Soft <td>Pol.</td> <td>Nat.</td> <td></td> <td></td> </td></td></td>	Pol.	Nat.	Rect. Matt Rect. Soft <td>Pol.</td> <td>Nat.</td> <td>Rect. Soft <td>Pol.</td> <td>Rect. Matt Rect. Soft <td>Pol.</td> <td>Nat.</td> <td></td> <td></td> </td></td>	Pol.	Nat.	Rect. Soft <td>Pol.</td> <td>Rect. Matt Rect. Soft <td>Pol.</td> <td>Nat.</td> <td></td> <td></td> </td>	Pol.	Rect. Matt Rect. Soft <td>Pol.</td> <td>Nat.</td> <td></td> <td></td>	Pol.	Nat.		
	Aresta - Edge Arête - Arista	Normal (1)	Rect.	Rect.	Normal (1)	Rect.	Rect.	Rect.	Rect.	Rect.	Rect.	Normal (1)	Rect.	Rect.	Rect.	Rect.	Rect.	Rect.	Normal		
ESPESSURA (MM) THICKNESS (MM) ÉPAISSEUR (MM) ESPESOR (MM)		7,7	8,5	8,0	8,5	8,5	8,0	8,5	8,0	9,8	9,3	9,8	9,3	8,2	8,2	7,7	10,5	9,8	10,5		
CAIXA BOX PAQUET CAJA	Nº Peças - No Pieces Nbre Pièces - N.º de piezas (2)	11	11	11	7	7	7														

CARACTERÍSTICAS TÉCNICAS

TECHNICAL CHARACTERISTICS

	MÉTODOS DE ENSAIO TEST METHODS	REVESTIMENTOS CERÂMICO VIDRADO GLAZED WALL TILES IN WHITE BODY GRUPO . GROUP BIII GL (EN 14411)		GRÉS PORCELÂNICO ESMALTADO GLAZED PORCELAIN TILES GRUPO . GROUP BIA GL (EN 14411) (C)				
		NORMA / STANDARD	VALORES MÉDIOS / AVERAGE VALUES		NORMA / STANDARD	VALORES MÉDIOS / AVERAGE VALUES		
			NAT	RECT		NAT / MATT NAT	MATT RECT / RECT	POL
ISO 10545 - 2	Comprimento e largura Length and width	± 0,75 mm [7 cm < N < 15 cm] ± 0,5% máx ± 2,0 mm [N ≥ 15 cm]	± 0,3 % máx ± 2,0 mm	± 0,2 % máx ± 1,0 mm	± 0,9 mm [N < 15 cm] ± 0,6% máx ± 2 mm [N ≥ 15 cm]	± 0,2% máx ± 1,0 mm	± 0,1% máx ± 1,0 mm	± 0,1% máx ± 1,0 mm
	Desvio da espessura média para a espessura de fabrico Deviation of mean thickness from manufacturing thickness	± 5 % máx ± 0,5 mm [N < 15 cm] ± 10 % máx ± 0,5 mm [N ≥ 15 cm]	± 5 % máx ± 0,5 mm	± 5 % máx ± 0,5 mm	± 0,5 mm [7 cm ≤ N < 15 cm] ± 0,5% máx ± 2,0 mm [N ≥ 15 cm]	± 5% máx ± 0,5 mm	± 5% máx ± 0,5 mm	± 5% máx ± 0,5 mm
	Retililinearidade das arestas Straightness of the edges	± 0,5 mm [7 cm < N < 15 cm] ± 0,3% máx 1,5 mm [N ≥ 15 cm]	± 0,3 % máx ± 2,0 mm	± 0,2 % máx ± 1,5 mm	± 0,75 mm [7 cm ≤ N < 15 cm] ± 0,5% máx ± 2,0 mm [N ≥ 15 cm]	± 0,3% máx ± 1,0 mm	± 0,2% máx ± 1,0 mm	± 0,2% máx ± 1,0 mm
	Ortogonalidade Orthogonality	± 0,75 mm [7 cm < N < 15 cm] ± 0,5% máx ± 2,0 mm [N ≥ 15 cm]	± 0,3 % máx ± 2,0 mm	± 0,2 % máx ± 1,5 mm	± 0,75 mm [7 cm ≤ N < 15 cm] ± 0,5% máx ± 2,0 mm [N ≥ 15 cm]	± 0,3% máx ± 1,5 mm	± 0,2% máx ± 1,5 mm	± 0,2% máx ± 1,5 mm
	Planaridade da superfície Surface flatness	+ 0,75 mm - 0,5 mm [7 cm < N < 15 cm] + 0,5% - 0,3% / + 2,0 mm - 1,5 mm [N ≥ 15 cm]	+ 0,3 % - 0,2% máx ± 2,0 mm	+ 0,3 % - 0,2% máx ± 1,8 mm	± 0,75 mm [7 cm ≤ N < 15 cm] ± 0,5% máx ± 2,0 mm [N ≥ 15 cm]	± 0,3% máx ± 1,8 mm	± 0,3% máx ± 1,8 mm	± 0,2% máx ± 1,8 mm
Qualidade da superfície (% isenta de defeitos) Surface quality (% defect-free)	≥ 95%	Cumprido Compliant	Cumprido Compliant	≥ 95%	Cumprido Compliant	Cumprido Compliant	Cumprido Compliant	
ISO 10545 - 3	Absorção de água Water absorption	> 10 %	> 16 % - 19%	> 16 % - 19%	< 0,5 %	< 0,5 %	< 0,5 %	< 0,5 %
ISO 10545 - 4	Resistência à Flexão (N): Bending Strength (N):	> 600	> 600	> 600				
	8,5 mm ≤ Espessura ≤ 10,5 mm 8,5 mm ≤ Thickness ≤ 10,5mm (e)	-	-	-	≥ 1300	> 3500	> 3500	> 3500
	Espessura < 8,5 mm Thickness < 8,5 mm (d)	-	-	-	≥ 1300	> 1500	> 1500	> 1500
	Módulo de ruptura (N / mm ²) Rupture modulus (N / mm ²)	> 15	> 15	> 15	> 35	> 40	> 40	> 40
ISO 10545 - 7	Resistência à abrasão (grupos PEI) Resistance to deep abrasion (PEI groups) (b)	-	-	-	Grupos PEI II - III - IV - V	Ensaio disponível Test available	Ensaio disponível Test available	-
ISO 10545 - 8	Coefficiente de dilatação térmica linear (da temperatura ambiente até 100 °C) Coefficient of linear thermal expansion (with atmospheric temperature up to 100 °C)	Método de ensaio disponível Test method available	Ensaio disponível Test available	Ensaio disponível Test available	Método de ensaio disponível Test method available	≤ 8,0x10 ⁻⁶ /°C	≤ 8,0x10 ⁻⁶ /°C	≤ 8,0x10 ⁻⁶ /°C
ISO 10545 - 11	Resistência à fendilhagem (vidrados) Cracking resistance (glazed)	Exigida Required	Resiste Resistant	Resiste Resistant	-	-	-	-
ISO 10545 - 12	Resistência ao gelo Resistance to frost	-	-	-	Exigida Required	Sem defeitos visíveis Resistant	Sem defeitos visíveis Resistant	Sem defeitos visíveis Resistant
ISO 10545 - 13 (a)	Resistência a ácidos e bases de alta concentração Resistance to acids and high concentration bases	Método de ensaio disponível Test method available	Ensaio disponível Test available	Ensaio disponível Test available	Método de ensaio disponível Test method available	Classe HA Type HA	Classe HA Type HA	Ensaio disponível Test available
	Resistência a ácidos e bases de baixa concentração Resistance to low concentrations of acids and alkalis	Método de ensaio disponível Test method available	Ensaio disponível Test available	Ensaio disponível Test available	Método de ensaio disponível Test method available	Classe LA Type LA	Classe LA Type LA	Min. Classe LB Min. Type LB
	Resistência a produtos químicos domésticos e aditivos para piscinas Resistance to household chemicals and swimming pool water additives	Min. Classe B Min. Type B	Classe A Type A	Classe A Type A	Min. Classe B Min. Type B	Classe A Type A	Classe A Type A	Ensaio disponível Test available
ISO 10545 - 14	Resistência às manchas Resistance to staining	Método de ensaio disponível Test method available	Min. Classe 4 Min. Type 4	Min. Classe 4 Min. Type 4	Min. Classe 3 Min. Type 3	Classe 5 Type 5	Classe 5 Type 5	Min. Classe 3 Min. Type 3
EN 13823 . EN 9239-1	Reacção ao fogo Reaction to fire	A1 _{FL}	Classe A1 Type A1	Classe A1 Tv A1	A1 _{FL}	Classe A1 _{FL} /Classe A1 Type A1 _{FL} /Type A1	Classe A1 _{FL} /Classe A1 Type A1 _{FL} /Type A1	Classe A1 _{FL} /Classe A1 Type A1 _{FL} /Type A1

NOTES · NOTAS

- (a) Exceto ao ácido fluorídico.
Except hydrofluoric acid.
- (b) Resistência à Abrasão (Grupos PEI):
 ** Pavimento destinado a locais com tráfego ligeiro. (Equivalente a PEI II / G2)
 *** Pavimento destinado a locais com tráfego moderado. (Equivalente a PEI III / G3)
 **** Pavimento destinado a locais com tráfego médio-forte. (Equivalente a PEI IV / G4)
 ***** Pavimento destinado a locais com tráfego forte, excepto locais públicos de tráfego intenso (Equivalente a PEI V / G5)
 Recomendamos a colocação de um tapete nas áreas de comunicação com o exterior (entrada, acesso ao jardim ou terraços), a fim de eliminar as areias e matérias abrasivas.
- (c) Resistance to abrasion (PEI Groups):
 ** Floor Tiles for light traffic areas. (Equivalent to PEI II / G2)
 *** Floor Tiles for regular traffic areas. (Equivalent to PEI III / G3)
 **** Floor Tiles for areas of considerable traffic. (Equivalent to PEI IV / G4)
 ***** Floor Tiles for heavy traffic areas, except for intensively used public places. (Equivalent to PEI V / G5).
 We recommend that a doormat be placed at the entrance of any doors leading outside (e.g. front door, garden or terrace doorways), in order to remove any abrasive particles (e.g.: sand).
- (d) Os produtos podem ser aplicados em piso radiante.
The products can be used with underfloor heating.
- (e) Resistência à flexão do formato 15x75x0,85 cm: > 1500 N
Bending strength of size 15x75x0,85 cm: > 1500 N
- (f) Resistência à flexão do formato 20x90x1,05 cm: ≥ 2000 N
Bending strength of size 20x90x1,05 cm: ≥ 2000 N

CARACTERÍSTICAS TÉCNICAS

TECHNICAL CHARACTERISTICS

	CARACTERÍSTICAS TÉCNICAS TECHNICAL CHARACTERISTICS MÉTODOS DE ENSAIO / TEST METHODS	GRÉS PORCELÂNICO TÉCNICO FULL BODY PORCELAIN TILES GRUPO . GROUP BIA UGL (EN 14411) (C)			
		NORMA / STANDARD	VALORES MÉDIOS / AVERAGE VALUES		
			NAT / MATT NAT	MATT RECT / RECT / SILK / SOFT / GRIP	POL
ISO 10545-2	Comprimento e largura Length and width	± 0,9 mm [N < 15 cm] ± 0,6% máx ± 2 mm [N ≥ 15 cm]	± 0,2% máx ± 1,0 mm	± 0,1% máx ± 1,0 mm	± 0,1% máx ± 1,0 mm
	Desvio da espessura média para a espessura de fabrico Deviation of mean thickness from manufacturing thickness	± 0,5 mm [7 cm ≤ N < 15 cm] ± 5% máx ± 0,5 mm [N ≥ 15 cm]	± 5% máx ± 0,5 mm	± 5% máx ± 0,5 mm	± 5% máx ± 0,5 mm
	Retililinearidade das arestas Straightness of the edges	± 0,75 mm [7 cm ≤ N < 15 cm] ± 0,5% máx ± 2,0 mm [N ≥ 15 cm]	± 0,3% máx ± 1,0 mm	± 0,2% máx ± 1,0 mm	± 0,2% máx ± 1,0 mm
	Ortogonalidade Orthogonality	± 0,75 mm [7 cm ≤ N < 15 cm] ± 0,5% máx ± 2,0 mm [N ≥ 15 cm]	± 0,3% máx ± 1,5 mm	± 0,2% máx ± 1,5 mm	± 0,2% máx ± 1,5 mm
	Planaridade da superfície Surface flatness	± 0,75 mm [7 cm ≤ N < 15 cm] ± 0,5% máx ± 2,0 mm [N ≥ 15 cm]	± 0,3% máx ± 1,8 mm	± 0,3% máx ± 1,8 mm	± 0,2% máx ± 1,8 mm
	Qualidade da superfície (% isenta de defeitos) Surface quality (% defect-free)	≥ 95%	Cumprido Compliant	Cumprido Compliant	Cumprido Compliant
ISO 10545-3	Absorção de água Water absorption	< 0,5%	< 0,05%	< 0,05%	< 0,05%
ISO 10545-4	Módulo de Ruptura (N/mm ²) Rupture modulus (N/mm ²)	> 35	> 45	> 45	> 45
	Resistência à Flexão (N): Bending Strength (N):				
	Espessura 20 mm Thickness 20 mm	≥ 1300	> 13500	> 13500	> 13500
	Espessura 14 mm Thickness 14 mm	≥ 1300	> 6500	> 6500	> 6500
	8,5 mm ≤ Espessura ≤ 10,5 mm 8,5 mm ≤ Thickness ≤ 10,5 mm	≥ 1300	> 3500	> 3500	> 3500
	Espessura < 8,5 mm Thickness < 8,5 mm	≥ 1300	> 1500	> 1500	> 1500
ISO 10545-6	Resistência à abrasão profunda (Volume removido/mm ³) Resistance to deep abrasion (Removed volume/mm ³)	< 175	< 120	< 120	< 120
ISO 10545-8	Coefficiente de Dilatação Térmica Linear (da temperatura ambiente até 100 °C) Coefficient of Linear Thermal Expansion (with atmospheric temperature up to 100 °C)	Método de ensaio disponível Test method available	≤ 8,0x10 ⁻⁶ / °C	≤ 8,0x10 ⁻⁶ / °C	≤ 8,0x10 ⁻⁶ / °C
ISO 10545-9	Resistência ao choque térmico Resistance to thermal shock	Exigida Required	Resiste Resistant	Resiste Resistant	Resiste Resistant
ISO 10545-12	Resistência ao gelo Resistance to frost	Exigida Required	Sem defeitos visíveis Without visible defects	Sem defeitos visíveis Without visible defects	Sem defeitos visíveis Without visible defects
ISO 10545-13 (a)	Resistência a Ácidos e Bases de Alta Concentração Resistance to Acids and High Concentration Bases	O produtor declara a classificação The producer declares the classification	Classe HA Type HA (b)	Classe HA Type HA (b)	Ensaio disponível Test available
	Resistência a Ácidos e Bases de Baixa Concentração Resistance to low concentrations of acids and alkalis		Classe LA Type LA (b)	Classe LA Type LA (b)	Min. Classe LB Min. Type LB
	Resistência a Produtos Químicos Domésticos e Aditivos para Água de Piscinas Resistance to Household Chemicals and Swimming pool water additives	Min. Classe B Min. Type B	Classe A Type A	Classe A Type A	Ensaio disponível Test available
ISO 10545-14	Resistência a manchas Resistance to staining	Método de ensaio disponível Test method available	Classe 5 Type 5	Classe 5 Type 5	Min. Classe 3 Min. Type 3
DIN 51130		Máx R13 Max R13	Ensaio disponível Test available	Ensaio disponível Test available	-
DIN 51097		Máx C Max C	Ensaio disponível Test available	Ensaio disponível Test available	-
ENV 12633	Resistência ao escorregamento Anti slip resistance	Máx classe 3 Max type 3	Ensaio disponível Test available	Ensaio disponível Test available	-
BS 7976		Valor de referência declarado Declared reference value	Ensaio disponível Test available	Ensaio disponível Test available	-
ANSI A137.1		Valor de referência declarado Declared reference value (DCOF) (d)	Ensaio disponível Test available	Ensaio disponível Test available	-
EN 13823 . EN 9239-1	Reacção ao fogo Reaction to fire	A1 _{FL}	Classe A1 _{FL} / Classe A1 Type A1 _{FL} / Type A1	Classe A1 _{FL} / Classe A1 Type A1 _{FL} / Type A1	Classe A1 _{FL} / Classe A1 Type A1 _{FL} / Type A1

NOTES · NOTAS

- (a) Exceto ao ácido fluorídico.
Except hydrofluoric acid.
- (b) Excepto Iron e Copper; Classe B e HB, Excluding Iron and Copper: Type B and HB.
- (c) Os produtos podem ser aplicados em piso radiante.
The products can be used with underfloor heating.
- (d) DCOF ≥ 0,42 espaços interiores expectável de serem utilizados húmidos.
DCOF ≥ 0,42 interior spaces expected to be used wet.

- Para os produtos com relevo, dado serem superfícies não planas, não são considerados os valores de curvatura e de empeno.
- As especificações técnicas são válidas unicamente para os produtos classificados de 1ª escolha. O incumprimento dos valores indicados em outras classificações comerciais não será motivo de reclamação.
- Valores típicos que correspondem a valores de referência de inspeção e ensaio.
- Estão indicados os valores considerados mais relevantes das Características Técnicas dos vários produtos. No entanto, no caso de ser necessária alguma informação adicional, solicitamos o contato para: revigres@revigres.pt

- In products with structured surfaces, curving and bending values are not considered.
- Technical specifications are only valid for the products classified as 1st choice. The non-performance of the indicated values for other commercial classifications will not be considered as grounds for complaint.
- Typical values corresponding to inspection and testing reference values.
- The values considered to be most significant in terms of the Technical Properties of all products are specified. For more information please contact us at: revigres@revigres.pt

CARACTERISTIQUES TECHNIQUES

CARACTERÍSTICAS TÉCNICAS

CARACTERISTIQUES TECHNIQUES

CARACTERÍSTICAS TÉCNICAS

	MÉTHODES D'ESSAI MÉTODOS DE PRUEBA	FAÏENCE PÂTE BLANCHE REVESTIMIENTOS CERÁMICOS VIDRIADOS GRUPE . GRUPO BIII GL (EN 14411)		GRÉS PORCELAINÉ ÉMAILLÉ GRES PORCELÁNICO ESMALTADO GRUPE . GRUPO . BIA GL (EN 14411) (C)				
		STANDARD / ESTÁNDAR	VALEURS MOYENNES / VALORES MEDIOS		STANDARD / ESTÁNDAR	VALEURS MOYENNES / VALORES MEDIOS		
			NAT	RECT		NAT / MATT NAT	MATT RECT / RECT	POL
ISO 10545 - 2	Longueur et largeur Longitud y anchura	± 0,75 mm [7 cm < N < 15 cm] ± 0,5% máx 2,0 mm [N ≥ 15 cm]	± 0,3 % máx ±2,0 mm	± 0,2 % máx ±1,0 mm	± 0,9 mm [N < 15 cm] ± 0,6% máx ± 2 mm [N ≥ 15 cm]	± 0,2% máx ± 1,0 mm	± 0,1% máx ± 1,0 mm	± 0,1% máx ± 1,0 mm
	Écart entre l'épaisseur moyenne et l'épaisseur standard Desvío del grosor medio con respecto grosor de fabricación	± 5 % máx ± 0,5 mm [N ≥ 15 cm] ± 10 % máx ± 0,5 mm [N ≥ 15 cm]	± 5 % máx ±0,5 mm	± 5 % máx ±0,5 mm	± 0,5 mm [7 cm ≤ N < 15 cm] ± 5% máx ± 2,0 mm [N ≥ 15 cm]	± 5% máx ± 0,5 mm	± 5% máx ± 0,5 mm	± 5% máx ± 0,5 mm
	Straight edges Retilinéarité des arêtes	± 0,5 mm [7 cm < N < 15 cm] ± 0,3% máx 1,5 mm [N ≥ 15 cm]	± 0,3 % máx ±2,0 mm	± 0,3 % máx ±2,0 mm	± 0,75 mm [7 cm ≤ N < 15 cm] ± 0,5% máx ± 2,0 mm [N ≥ 15 cm]	± 0,3% máx ± 1,0 mm	± 0,2% máx ± 1,0 mm	± 0,2% máx ± 1,0 mm
	Orthogonalité ortogonalidad	± 0,75 mm [7 cm < N < 15 cm] ± 0,5% máx 2,0 mm [N ≥ 15 cm]	± 0,3 % máx ±2,0 mm	± 0,2 % máx ±1,5 mm	± 0,75 mm [7 cm ≤ N < 15 cm] ± 0,5% máx ± 2,0 mm [N ≥ 15 cm]	± 0,3% máx ± 1,5 mm	± 0,2% máx ± 1,5 mm	± 0,2% máx ± 1,5 mm
	Planéité de la surface Planeidad de la superficie	+ 0,75 mm -0,5 mm [7 cm < N < 15 cm] + 0,5% - 0,3% / + 2,0 mm - 1,5 mm [N ≥ 15 cm]	+ 0,3 % - 0,2% máx ±2,0 mm	+ 0,3 % - 0,2% máx ±1,8 mm	± 0,75 mm [7 cm ≤ N < 15 cm] ± 0,5% máx ± 2,0 mm [N ≥ 15 cm]	± 0,3% máx ± 1,8 mm	± 0,3% máx ± 1,8 mm	± 0,2% máx ± 1,8 mm
	Qualité de la surface (% sans défauts) Calidad de la superficie (% exenta de defectos)	≥ 95%	Conforme Cumple	Conforme Cumple	≥ 95%	Conforme Cumple	Conforme Cumple	Conforme Cumple
	Absorption d'eau Absorción del agua	> 10 %	> 16 % - 19%	> 16 % - 19%	< 0,5 %	< 0,5 %	< 0,5 %	< 0,5 %
ISO 10545 - 3	Résistance à la flexion (N) Resistencia a la flexión (N)	> 600	> 600	> 600				
	8,5 mm ≤ Épaisseur ≤ 10,5 mm 8,5 mm ≤ Grosor ≤ 10,5 mm (e)	-	-	-	≥ 1300	> 3500	> 3500	> 3500
	Épaisseur < 8,5 mm Grosor < 8,5 mm (d)	-	-	-	≥ 1300	> 1500	> 1500	> 1500
	Module de rupture (N / mm²) Módulo de ruptura (N / mm²)	> 15	> 15	> 15	> 35	> 40	> 40	> 40
ISO 10545 - 4	Résistance à l'abrasion (groupes PEI) Resistencia a la abrasión (grupos PEI) (b)	-	-	-	Groupes PEI Grupos PEI II - III - IV - V	Essai disponible Ensayo disponible	Essai disponible Ensayo disponible	-
	Coefficient de dilatation thermique linéaire (de la température ambiante jusqu'à 100°C) Coeficiente de dilatación térmica lineal (de la temperatura ambiente hasta 100 °C)	Méthode d'essai disponible Método de ensayo disponible	Essai disponible Ensayo disponible	Essai disponible Ensayo disponible	Méthode d'essai disponible Método de ensayo disponible	≈ 8,0x10 ⁻⁴ /°C	≈ 8,0x10 ⁻⁴ /°C	≈ 8,0x10 ⁻⁴ /°C
ISO 10545 - 7	Résistance au tressailage Resistencia al cuarteado (vidriados)	Requis Exigida	Résistant Resistente	Résistant Resistente	-	-	-	-
	Résistance au gel Resistencia al hielo	-	-	-	Exigida Required	Sans défaut apparent Sin defectos visibles	Sans défaut apparent Sin defectos visibles	Sans défaut apparent Sin defectos visibles
ISO 10545 - 8	Résistance aux acides et aux bases à haute concentration resistencia a ácidos y bases de alta concentración	Méthode d'essai disponible Método de ensayo disponible	Essai disponible Ensayo disponible	Essai disponible Ensayo disponible	Méthode d'essai disponible Método de ensayo disponible	Classe HA Clase HA	Classe HA Clase HA	Essai disponible Ensayo disponible
	Résistance aux acides et aux bases à faible concentration Resistencia a ácidos y bases de baja concentración	Méthode d'essai disponible Método de ensayo disponible	Essai disponible Ensayo disponible	Essai disponible Ensayo disponible	Méthode d'essai disponible Método de ensayo disponible	Classe LA Clase LA	Classe LA Clase LA	Min. Classe LB Min. Type LB
	Résistance aux produits chimiques ménagers et aux additifs pour eau de piscine: dalles vitrées Resistencia a productos químicos domésticos y aditivos para agua de piscinas: ladrillos vidriados	Min. Classe B Min. Type B	Classe A Clase A	Classe A Clase A	Min. Classe B Min. Classe B	Classe A Clase A	Classe A Clase A	Essai disponible Ensayo disponible
ISO 10545 - 11	Résistance aux taches Resistencia antimanchas	Méthode d'essai disponible Método de ensayo disponible	Min. Classe 4 Min. Classe 4	Min. Classe 4 Min. Classe 4	Min. Classe 3 Min. Type 3	Classe 5 Clase 5	Classe 5 Clase 5	Min. Classe 3 Min. Classe 3
	Réaction au feu Reacción al fuego	A1 _{FL}	Classe A1 Clase A1	Classe A1 Clase A1	A1 _{FL}	Classe A1 _{FL} /Classe A1 ClaseA1 _{FL} /Type A1	Classe A1 _{FL} /Classe A1 ClaseA1 _{FL} /Type A1	Classe A1 _{FL} /Classe A1 ClaseA1 _{FL} /Type A1

	MÉTHODES D'ESSAI MÉTODOS DE PRUEBA	GRÉS PORCELAINÉ PLEINE MASSE GRES PORCELÁNICO TÉCNICO GRUPE . GRUPO BIA UGL (EN 14411) (C)			
		STANDARD / ESTÁNDAR	VALEURS MOYENNES / VALORES MEDIOS		
			NAT / MATT NAT	MATT RECT / RECT / SILK / SOFT / GRIP	POL
ISO 10545 - 2	Longueur et largeur Longitud y anchura	± 0,9 mm [N < 15 cm] ± 0,6% máx ± 2 mm [N ≥ 15 cm]	± 0,2% máx ± 1,0 mm	± 0,1% máx ± 1,0 mm	± 0,1% máx ± 1,0 mm
	Écart entre l'épaisseur moyenne et l'épaisseur standard Desvío del grosor medio con respecto grosor de fabricación	± 0,5 mm [7 cm ≤ N < 15 cm] ± 5% máx ± 0,5 mm [N ≥ 15 cm]	± 5% máx ± 0,5 mm	± 5% máx ± 0,5 mm	± 5% máx ± 0,5 mm
	Rectilinéarité des côtés (côtés de la face principale) Rectilinearidad de los lados (lados de la cara principal)	± 0,75 mm [7 cm ≤ N < 15 cm] ± 0,5% máx ± 2,0 mm [N ≥ 15 cm]	± 0,3% máx ± 1,0 mm	± 0,2% máx ± 1,0 mm	± 0,2% máx ± 1,0 mm
	Orthogonalité Ortogonalidad	± 0,75 mm [7 cm ≤ N < 15 cm] ± 0,5% máx ± 2,0 mm [N ≥ 15 cm]	± 0,3% máx ± 1,5 mm	± 0,2% máx ± 1,5 mm	± 0,2% máx ± 1,5 mm
	Planéité de la surface Planeidad de la superficie	± 0,75 mm [7 cm ≤ N < 15 cm] ± 0,5% máx ± 2,0 mm [N ≥ 15 cm]	± 0,3% máx ± 1,8 mm	± 0,3% máx ± 1,8 mm	± 0,2% máx ± 1,8 mm
	Qualité de la surface (% sans défauts) Calidad de la superficie (% exenta de defectos)	≥ 95%	Conforme Cumple	Conforme Cumple	Conforme Cumple
	Absorption d'eau Absorción del agua	< 0,5%	< 0,05%	< 0,05%	< 0,05%
ISO 10545 - 3	Module de rupture (N/mm²) Módulo de Ruptura (N/mm²)	> 35	> 45	> 45	> 45
	Résistance à la flexion (N) Resistencia a la Flexión (N)				
	Épaisseur 20 mm Grosor 20 mm	≥ 1300	> 13500	> 13500	> 13500
	Épaisseur 14 mm Grosor 14 mm	≥ 1300	> 6500	> 6500	> 6500
	8,5 mm ≤ Épaisseur ≤ 10,5 mm 8,5 mm ≤ Grosor ≤ 10,5 mm	≥ 1300	> 3500	> 3500	> 3500
ISO 10545 - 4	Épaisseur < 8,5 mm Grosor < 8,5 mm	≥ 1300	> 1500	> 1500	> 1500
	Module de rupture (N / mm²) Módulo de ruptura (N / mm²)	> 15	> 15	> 15	> 40
ISO 10545 - 6	Résistance à l'abrasion profonde (volume extrait, mm³) Resistencia a la abrasión profunda (Volumen extraído/mm³)	< 175	< 120	< 120	< 120
	Coefficient de dilatation thermique linéaire (de la température ambiante jusqu'à 100°C) Coeficiente de dilatación térmica lineal (de la temperatura ambiente hasta 100 °C)	Méthode d'essai disponible Método de ensayo disponible	≤ 8,0x10 ⁻⁴ / °C	≤ 8,0x10 ⁻⁴ / °C	≤ 8,0x10 ⁻⁴ / °C
ISO 10545 - 8	Résistance aux chocs thermiques Resistencia al impacto térmico	Requis Exigida	Résistant Resistente	Résistant Resistente	Résistant Resistente
ISO 10545 - 9	Résistance aux produits chimiques ménagers et aux additifs pour eau de piscine: dalles vitrées Resistencia a productos químicos domésticos y aditivos para agua de piscinas	Min. Classe B Min. Type B	Classe A Clase A	Classe A Clase A	Essai disponible Ensayo disponible
ISO 10545 - 12	Résistance aux acides et aux bases à haute concentration Resistencia a ácidos y bases de alta concentración	Le producteur déclare la classification El productor declara la clasificación	Sans défaut apparent Sin defectos visibles	Sans défaut apparent Sin defectos visibles	Sans défaut apparent Sin defectos visibles
	Résistance aux acides et aux bases à faible concentration Resistencia a ácidos y bases de baja concentración	Classe HA Clase HA (b)	Classe LA Clase LA (b)	Classe LA Clase LA (b)	Essai disponible Ensayo disponible
ISO 10545 - 13	Résistance aux acides et aux bases à haute concentration Resistencia a ácidos y bases de alta concentración	Le producteur déclare la classification El productor declara la clasificación	Sans défaut apparent Sin defectos visibles	Sans défaut apparent Sin defectos visibles	Sans défaut apparent Sin defectos visibles
	Résistance aux acides et aux bases à faible concentration Resistencia a ácidos y bases de baja concentración	Classe A Clase A	Classe A Clase A	Classe A Clase A	Essai disponible Ensayo disponible
ISO 10545 - 14	Résistance aux taches Resistencia antimanchas	Méthode d'essai disponible Método de ensayo disponible	Classe 5 Clase 5	Classe 5 Clase 5	Min. Classe 3 Min. Classe 3
DIN 51130	Résistance aux taches Resistencia antimanchas	Méthode d'essai disponible Método de ensayo disponible	Classe 5 Clase 5	Classe 5 Clase 5	Min. Classe 3 Min. Classe 3
DIN 51097	Résistance aux taches Resistencia antimanchas	Méthode d'essai disponible Método de ensayo disponible	Classe 5 Clase 5	Classe 5 Clase 5	Min. Classe 3 Min. Classe 3
ENV 12633	Résistance à la glissance Resistencia antideslizamiento	Méthode d'essai disponible Método de ensayo disponible	Classe 5 Clase 5	Classe 5 Clase 5	Min. Classe 3 Min. Classe 3
BS 7976	Résistance à la glissance Resistencia antideslizamiento	Méthode d'essai disponible Método de ensayo disponible	Classe 5 Clase 5	Classe 5 Clase 5	Min. Classe 3 Min. Classe 3
ANSI A137.1	Résistance à la glissance Resistencia antideslizamiento	Méthode d'essai disponible Método de ensayo disponible	Classe 5 Clase 5	Classe 5 Clase 5	Min. Classe 3 Min. Classe 3
EN 13823 EN 9239-1	Réaction au feu Reacción al fuego	A1 _{FL}	Classe A1 _{FL} /Classe A1 ClaseA1 _{FL} /Type A1	Classe A1 _{FL} /Classe A1 ClaseA1 _{FL} /Type A1	Classe A1 _{FL} /Classe A1 ClaseA1 _{FL} /Type A1

NOTES · NOTAS

- (a) Sauf à l'acide fluorhydrique.
Excepto al ácido fluorhídrico.
- (b) Résistance à l'abrasion (Groupes PEI):
 *** Revêtement de sol destiné aux endroits à faible circulation. (Équivalent à PEI II / G2)
 **** Revêtement de sol destiné aux endroits à circulation modérée. (Équivalent à PEI III / G3)
 ***** Revêtement de sol destiné aux endroits à circulation moyenne et intense. (Équivalent à PEI IV / G4)
 ***** Revêtement de sol destiné aux endroits à circulation intense, à l'exception des lieux publics intenses (Équivalent à PEI V / G5)
 Nous vous recommandons la pose d'un tapis sur les zones de communication avec l'extérieur (entrée, accès au jardin ou aux terrasses), afin d'éliminer les grains de sable et les matières abrasives.
- (b) Resistencia a la Abrasión (Grupos PEI):
 *** Pavimento destinado a lugares con tráfico ligero. (Equivalente a PEI II / G2)
 **** Pavimento destinado a lugares con tráfico moderado. (Equivalente a PEI III / G3)
 ***** Pavimento destinado a lugares con tráfico medio-fuerte. (Equivalente a PEI IV / G4)
 ***** Pavimento destinado a lugares con tráfico fuerte, excepto lugares públicos de tráfico intenso (Equivalente a PEI V / G5).
 Recomendamos la colocación de una alfombra en las áreas de comunicación con el exterior (entrada, acceso al jardín o a las terrazas), con el fin de eliminar las arenas y los materiales abrasivos.

- (c) Les produits peuvent être posés sur sols chauffants.
Los productos pueden aplicarse en suelos radiantes.
- (d) Résistance à la flexion du format 15x75x0,85 cm : >1300 N
Resistencia a la flexión del formato 15x75x0,85 cm: >1300 N
- (e) Résistance à la flexion du format 20x90x1,05 cm > 3000N
Resistencia a la flexión del formato 20x90x1,05 cm > 3000N

NOTES · NOTAS

- (a) Sauf à l'acide fluorhydrique.
Excepto al ácido fluorhídrico.
- (b) Sauf Iron et Copper : classe B et HB.
Excepto Iron y Copper: clase B y HB.
- (c) Les produits peuvent être posés sur sols chauffants.
Los productos pueden aplicarse en suelos radiantes.
- (d) DCOF ≥ 0,42 Espaces intérieurs présumés d'être utilisés humides.
DCOF ≥ 0,42 espacios interiores que presumiblemente se vayan a utilizar húmedos.

1. Pour les produits à reliefs, étant donné qu'il s'agit de surfaces non planes, les valeurs de bombement et de gauchissement ne sont pas considérées.
2. Les spécifications techniques ne sont valables que pour les produits classés de 1er choix. Le non respect des valeurs indiquées pour d'autres classifications commerciales ne pourra donner lieu à réclamation.
3. Valeurs typiques qui correspondent aux valeurs de référence de contrôle et d'essai.
4. Sont indiquées les valeurs les plus pertinentes des Caractéristiques Techniques des différents produits. Toutefois, pour toutes informations complémentaires, la direction technique reste à votre disposition. Contactez-nous à: revigres@revigres.pt
1. Para los productos con relieve, al tratarse de superficies no planas, no se considerarán los valores de curvatura y deformación.
2. Las características técnicas son válidas únicamente para los productos clasificados como 1ª opción. El incumplimiento de los valores indicados para otras categorías comerciales no podrá ser motivo de reclamación.
3. Valores típicos que corresponden a los valores de referencia de inspección y ensayo.
4. Se indican los valores más relevantes de las características técnicas de los distintos productos. Para más información, pueden contactar con: revigres@revigres.pt

CERTIFICADOS

CERTIFICATES _ CERTIFICATS _ CERTIFICADOS

A Revigrés tem a quádrupla certificação dos seus sistemas de gestão integrados, nos seguintes referenciais: Qualidade; Ambiente; Responsabilidade Social; Investigação, Desenvolvimento e Inovação.

Revigrés has quadruple certification of its integrated management systems in terms of the following standards: Quality; Environment; Social Accountability; Research, Development and Innovation.

Revigrés possède une quadruple certification de ses systèmes de gestion intégrés dans les référentiels suivants: Qualité; Environnement; Responsabilité Sociale; Recherche, Développement et Innovation.

Revigrés cuenta con una quádruple certificación de sus sistemas de gestión integrados, en las siguientes categorías: Calidad; Medio Ambiente; Responsabilidad Social; Investigación, Desarrollo e Innovación.



NP EN ISO 9001: 2015
1.ª empresa do setor de revestimentos e pavimentos cerâmicos CERTIFICADA PELO SISTEMA DE GESTÃO DA QUALIDADE

NP EN ISO 9001: 2015
1st company in the wall and floor ceramic tiles sector to be CERTIFIED FOR ITS QUALITY MANAGEMENT SYSTEM

NP EN ISO 9001: 2015
1re entreprise du secteur des revêtements de sol et muraux en céramique CERTIFIÉE POUR SON SYSTÈME DE GESTION DE LA QUALITÉ

NP EN ISO 9001: 2015
1.ª empresa del sector de revestimientos y pavimentos cerámicos CERTIFICADA POR EL SISTEMA DE GESTIÓN DE LA CALIDAD

NP EN ISO 14001 : 2015
CERTIFICAÇÃO DO SISTEMA DE GESTÃO AMBIENTAL

NP EN ISO 14001 : 2015
ENVIRONMENTAL MANAGEMENT SYSTEM CERTIFICATION

NP EN ISO 14001 : 2015
CERTIFICATION DU SYSTÈME DE GESTION DE L'ENVIRONNEMENT

NP EN ISO 14001 : 2015
CERTIFICACIÓN DEL SISTEMA DE GESTIÓN AMBIENTAL

NP 4469: 2019
1.ª e única empresa do setor cerâmico CERTIFICADA PELO SISTEMA DE GESTÃO DA RESPONSABILIDADE SOCIAL

NP 4469: 2019
1st and only company in the ceramic sector CERTIFIED BY SOCIAL ACCOUNTABILITY MANAGEMENT SYSTEM

NP 4469: 2019
1re et unique entreprise du secteur céramique CERTIFIÉE POUR SYSTÈME DE GESTION DE LA RESPONSABILITÉ SOCIALE

NP 4469: 2019
1.ª y única empresa del sector cerámico certificada por el SISTEMA DE GESTIÓN DE RESPONSABILIDAD SOCIAL

NP 4457: 2007
1.ª e única empresa do setor cerâmico CERTIFICADA PELO SISTEMA DE GESTÃO DA INVESTIGAÇÃO, DESENVOLVIMENTO E INOVAÇÃO

NP 4457: 2007
1st and only company in the ceramic sector CERTIFIED BY RESEARCH, DEVELOPMENT AND INNOVATION MANAGEMENT SYSTEM

NP 4457: 2007
1re et unique entreprise du secteur céramique CERTIFIÉE POUR SYSTÈME DE GESTION DE LA RECHERCHE, DU DÉVELOPPEMENT ET DE L'INNOVATION

NP 4457: 2007
1.ª y única empresa del sector cerámico CERTIFICADA POR EL SISTEMA DE GESTIÓN DE LA INVESTIGACIÓN, EL DESARROLLO Y LA INNOVACIÓN

As cores podem apresentar ligeiras diferenças de tonalidade. A Revigrés reserva-se o direito de eliminar ou modificar, qualquer dos modelos, cores, formatos, referências e preços contidos neste catálogo.
Colours may show slight shade variations. Revigrés reserves the right to eliminate or change any model, colour, format, reference and price in this catalogue.
Les coloris peuvent présenter de légères différences de teinte. Revigrés se réserve le droit de supprimer ou de modifier les modèles, les couleurs, les formats, les références et les prix contenus dans ce catalogue.
Los colores pueden presentar ligeras diferencias de tonalidad. Revigrés se reserva el derecho de eliminar o modificar cualquiera de los modelos, los colores, los formatos, las referencias y los precios de este catálogo.



ÁGUEDA:

Apartado 1 · 3754-001 BARRÔ AGD · Portugal
Tel. +351 234 660 100 [1]
GPS 40.532865 N, 8.449056 W (Gândara do Vale do Grou)

LISBOA:

Pç. José Fontana 26 A-C · 1050-129 LISBOA · Portugal
Tel. +351 213 170 280 [1]
GPS 38.730144 N, 9.144978 W

Showrooms:

2^a a 6^a feira: 9:00-19:30h (Águeda: 19:00h); Sábado: 9:30-13:30h
Monday to Friday: 9.00am-7.30pm (Águeda: 7.00pm); Saturday: 9.30am-1.30pm

revigres@revigres.pt

www.revigres.com

