

Valadares

ORIGINAL BATHROOMS

SINCE 1921

2024

TABELA DE PREÇOS
TARIFA DE PRECIOS
PRICE LIST



Índice | Index



COLEÇÕES SANITÁRIAS
COLECCIONES SANITARIAS
SANITARY COLLECTIONS

010



ESTRUTURAS
ESTRUCTURAS
STRUCTURES

062



LAVATÓRIOS
LAVABOS
WASHBASINS

072



MÓVEIS
MUEBLES
FURNITURE

102



TORNEIRAS
GRIFERIA
TAPS

118



ESPAÇOS PÚBLICOS
ESPACIOS PÚBLICOS
PUBLIC SPACES

186



BASES DE CHUVEIRO
PLATOS DE DUCHA
SHOWER TRAYS

212



BANHEIRAS
BAÑERAS
BATHTUBS

222









RESGUARDOS
MAMPARAS
SHOWER CABINS

232

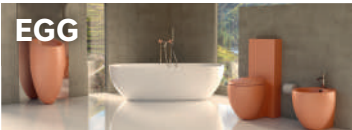

ACESSÓRIOS CERÂMICOS
ACCESORIOS CERÁMICA
CERAMIC ACCESSORIES

242

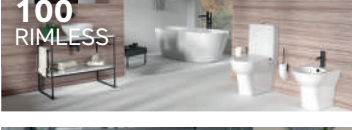
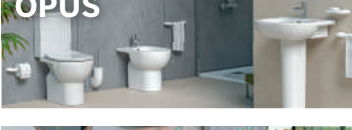
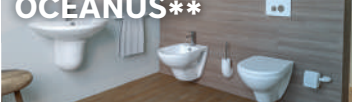
	COMPACTA <i>Para tanque bajo . Close coupled</i>	NORMAL	BTW	SUSPENSA <i>Suspendida . Wall hung</i>
	Sanita + tanque + mecanismo + tampo SC Inodoro + tanque + mecanismo + tapa SC WC + cistern + mechanism + SC seat <i>Branco . Blanco . White</i>	Sanita + tampo Inodoro + tapa WC + seat <i>Branco . Blanco . White</i>	Sanita + tampo SC Inodoro + tapa SC WC + SC seat <i>Branco . Blanco . White</i>	Sanita + tampo SC Inodoro + tapa SC WC + SC seat <i>Branco . Blanco . White</i>
EGG 	1.181 € PAG. 18		594 € PAG. 18	570 € PAG. 19
NAUTILUS RIMLESS 	665 € PAG. 22			436 € PAG. 23
ONE 	660 € PAG. 26			382 € PAG. 27
TWO RIMLESS 	496 € PAG. 31			270 € PAG. 33
TWO BTW RIMLESS 			322 € PAG. 32	
LIGHT 				400 € PAG. 37
NEOCLÁSSICA* 	693 € PAG. 39	798 € PAG. 40	521 € PAG. 42	607 € PAG. 43
100 RIMLESS 	410 € PAG. 48			233 € PAG. 49
OPUS 	311 € PAG. 52		211 € PAG. 52	210 € PAG. 53
OCEANUS** 	225 € PAG. 57	134 € PAG. 58		134 € PAG. 58

*O conjunto Neoclássica Normal considerado é Neoclássica com tanque alto. Neste caso estão considerados sanita + tanque + mecanismo + tampo SC.
 El conjunto Neoclássica Normal considerado es Neoclássica con tanque alto. En este caso, se considera inodoro + tanque + mecanismo + tapa SC.
 The set Neoclássica Normal considered is Neoclássica with high level cistern. In this case are considered WC + Cistern + mechanism + SC seat.

**Conjunto Oceanus apenas dispõe de tampo de descida normal.
 El conjunto Oceanus solo tiene tapa de queda normal.
 Oceanus set only has normal descent toilet seat.



PACK 100



SANITA SUSPensa RIMLESS + TAMPO SC

*Inodoro Suspendido Rimless + Tapa SC
Wall Hung WC Rimless + Toilet Seat SC*

REF
42501002KT

230 €

SANITA SUSPensa RIMLESS + TAMPO

*Inodoro Suspendido Rimless + Tapa
Wall Hung WC Rimless + Toilet Seat*

REF
42501002KN

206 €

ver pag. 51 . see pag. 51



PACK OPUS



SANITA COMPACTA + TANQUE + TAMPO SC

*Inodoro para tanque bajo + Tanque + Tapa SC
Close coupled WC + Cistern + Toilet Seat SC*

REF
37904002K

305 €

SANITA COMPACTA + TANQUE + TAMPO

*Inodoro para tanque bajo + Tanque + Tapa
Close coupled WC + Cistern + Toilet Seat*

REF
37900002K

283 €

ver pag. 55 . see pag. 55



PACK OCEANUS



SANITA COMPACTA + TANQUE + TAMPO

*Inodoro para tanque bajo + Tanque + Tapa
Close coupled WC + Cistern + Toilet Seat*

REF
13900002K

224 €

ver pag. 60 . see pag. 60

informações

información · information

abreviaturas

abreviaturas · abbreviations

	PT	ES	EN
SC	Tampo soft-close	Tapa soft-close	Soft-close toilet seat
CM	Tampo em contraplacado marítimo	Tapa en laminado marino	Toilet seat in marine plywood
V	Sanita de descarga vertical	Inodoro de descarga vertical	Vertical outlet WC
H	Sanita de descarga horizontal	Inodoro de descarga horizontal	Horizontal outlet WC
VCC	Válvula clic-clac	Válvula clic-clac	Pop-up waste
DD	Mecanismo de dupla descarga	Mecanismo de doble descarga	Dual flush mechanism
PMR	Pessoas com mobilidade reduzida	Personas con movilidad reducida	People with reduced mobility
	CORES STANDARD:	COLORES STANDARD:	STANDARD COLORS:
	Preto Ardósia Branco Ártico	Negro Pizarra Blanco Ártico	Black Slate Artic White

NOTAS IMPORTANTES | NOTA IMPORTANTE | IMPORTANT NOTES:

Qualquer alteração de especificação dos produtos constantes da presente tabela de preços terá um agravamento de 10% aos preços indicados.

Cualquier cambio en la especificación de los productos enumerados en esta tarifa de precios dará lugar a un aumento del 10% en relación con los precios indicados.

Any change in the specification of the products listed in this price list will result in an increase of 10% in relation to the indicated prices.

A presente tabela de preços entra em vigor em Janeiro 2024

Esta tarifa de precios entra en vigor en Enero de 2024

This price list takes effect in January 2024

simbologia

simbologia · symbology



Descarga eficaz c/ 2,5L/ 4L
Descarga efectiva c/ 2,5L/ 4L
Effective discharge w/ 2,5L/ 4L



Descarga eficaz c/ 3L/ 5L
Descarga efectiva c/ 3L/ 5L
Effective discharge w/ 3L/ 5L



Estructuras de sanita suspendida con 10 años de garantía
Estructuras para inodoro suspendido con 10 años de garantía
Conceled systems for wall - hung WC with 10 year warranty



Sanita c/ comprimento 60cm
Inodoro con longitud 60cm
WC length 60cm



Resistência ao escorregamento
Resistencia a la resbaladidad
Resistance slip



Artigos cerâmico com 20 anos de garantia
Artículos cerámicos con 20 años de garantía
Ceramic articles with 20 years warranty



Tampo soft-close
Tapa soft-close
Soft-close toilet seat



Certificação hídrica do autoclismo
Certificación hidrica
Hydric certification toilet



G[®]
GRESANIT[®]

	00	23	46	20	18	41	21	28	15
	BRANCO BLANCO WHITE	BRANCO ÁRTICO BLANCO ÁRTICO WHITE ARTIC	MARFIL MARFIL IVORY	PERGAMON	AMARELO SAARA AMARILLO SAARA YELLOW SAARA	ROSA QUARTZO ROSA CUARZO ROSE QUARTZ	AZUL CAPRI BLUE CAPRI	VERDE JADE JADE VERDE JADE GREEN	CAPPUCCINO
EGG	•	•			•	•			•
NAUTILUS	•	•							•
ONE	•	•	•		•	•			•
NEOCLÁSSICA	•	•		•					
TWO	•	•							
LIGHT	•	•							
100	•								
OPUS	•								
OCEANUS	•								
JÚNIOR	•								
PMR	•								
URINÓIS URINARIOS URINALS	•								
LAVATÓRIOS POUSAR LAVABOS SOBRE MUEBLE STANDING WASHBASINS	•	•	•		•	•	•	•	•
LAVATÓRIOS ESPECIAIS LAVABOS ESPECIALES SPECIAL WASHBASINS	•	•							
OUTROS LAVATÓRIOS OTROS LAVABOS OTHER WASHBASINS	•								
BASES DE CHUVEIRO PLATOS DE DUCHA SHOWER TRAYS	•								
PEÇAS TÉCNICAS PIEZAS TÉCNICAS TECHNICAL PIECES	•								
ACESSÓRIOS ACCESORIOS ACCESSORIES	•								
TORNEIRAS LUNA GRIFOS LUNA LUNA TAPS	•	•							
PLACA CERÂMICA ENCIMERA EN CERÁMICA CERAMIC TOP	•	•							

torneiras e estruturas para lavatórios

grifería y estructuras para lavabos .
taps and structures for washbasins



0 Níquel escovado . Níquel pulido .
Brushed nickel



3 Preto mate . Negro mate .
Black matt



1 Branco . Blanco .
White



4 Dourado . Dorado .
Gold



2 Cromado .
Cromo . Chrome



5 Dourado mate . Dorado mate .
Gold matt





COLEÇÕES SANITÁRIAS

COLECCIONES SANITARIAS
SANITARY COLLECTIONS



EGG 18

NAUTILUS 22

ONE 26

TWO 31

LIGHT 37

NEOCLÁSSICA 39

100 48

OPUS 52

OCEANUS 57



EGG



SANITA COMPACTA
INODORO P/ TANQUE BAJO
CLOSE COUPLED WC
PAG 18



SANITA NORMAL BTW
INODORO P/ TANQUE EMPOTRADO BTW
WC CONCEALED BTW
PAG 18



SANITA SUSPENSA
INODORO SUSPENDIDO
WALL HUNG WC
PAG 19



BIDÉ
BIDÉ
BIDET
PAG 19



BIDÉ SUSPENSO
BIDÉ SUSPENDIDO
WALL HUNG BIDET
PAG 19



LAVATÓRIO
LAVABO
WASHBASIN
PAG 20



LAVATÓRIO SUSPENSO
LAVABO SUSPENDIDO
WALL HUNG WASHBASIN
PAG 20



LAVATÓRIO POUSAR
LAVABO SOBRE MUEBLE
STANDING WASHBASIN
PAG 20

NAUTILUS



SANITA COMPACTA
INODORO P/ TANQUE BAJO
CLOSE COUPLED WC
PAG 22



SANITA SUSPENSA
INODORO SUSPENDIDO
WALL HUNG WC
PAG 23



BIDÉ
BIDÉ
BIDET
PAG 22



BIDÉ SUSPENSO
BIDÉ SUSPENDIDO
WALL HUNG BIDET
PAG 23



LAVATÓRIO MÉDIO
LAVABO MÉDIO
WASHBASIN MEDIUM
PAG 24



LAVATÓRIO MÉDIO SUSPENSO
LAVABO MÉDIO SUSPENDIDO
WALL HUNG WASHBASIN MEDIUM
PAG 24



ONE



SANITA COMPACTA
INODORO P/ TANQUE BAJO
CLOSE COUPLED WC
PAG 26



SANITA SUSPENSA
INODORO SUSPENDIDO
WALL HUNG WC
PAG 27



BIDÉ
BIDÉ
BIDET
PAG 26



BIDÉ SUSPENSO
BIDÉ SUSPENDIDO
WALL HUNG BIDET
PAG 27



LAVATÓRIO ONE LINE
LAVABO ONE LINE
WASHBASIN ONE LINE
PAG 28



LAVATÓRIO ONE SLIM
LAVABO ONE SLIM
WASHBASIN ONE SLIM
PAG 29



TWO



SANITA COMPACTA
INODORO P/ TANQUE BAJO
CLOSE COUPLED WC
PAG 31



SANITA NORMAL BTW
INODORO P/ TANQUE EMPOTRADO BTW
WC CONCEALED BTW
PAG 32



SANITA SUSPENSA
INODORO SUSPENDIDO
WALL HUNG WC
PAG 33



BIDÉ
BIDÉ
BIDET
PAG 33



BIDÉ SUSPENSO
BIDÉ SUSPENDIDO
WALL HUNG BIDET
PAG 34



LIGHT



SANITA SUSPENSA
INODORO SUSPENDIDO
WALL HUNG WC
PAG 37



BIDÉ SUSPENSO
BIDE SUSPENDIDO
WALL HUNG BIDE
PAG 38



LAVATÓRIO
LAVABO
WASHBASIN
PAG 38

NEOCLÁSSICA



SANITA COMPACTA
INODORO P/ TANQUE BAJO
CLOSE COUPLED WC
PAG 39



SANITA NORMAL BTW
INODORO P/ TANQUE EMPOTRADO BTW
WC CONCEALED BTW
PAG 42



SANITA NORMAL TANQUE ALTO
INODORO NORMAL TANQUE ALTO
WC CONCEALED HIGH LEVEL CISTERN
PAG 40



SANITA NORMAL
INODORO P/ TANQUE EMPOTRADO
WC CONCEALED
PAG 40



SANITA SUSPENSA
INODORO SUSPENDIDO
WALL HUNG WC
PAG 43



SANITA NORMAL BTW H/V
INODORO P/TANQUE EMPOTRADO H/V
WC CONCEALED BTW H/V
PAG 41



BIDÉ BTW
BIDÉ BTW
BIDET BTW
PAG 42



BIDÉ SUSPENSO
BIDÉ SUSPENDIDO
WALL HUNG BIDE
PAG 43



BIDÉ
BIDÉ
BIDET
PAG 40



LAVA MÃOS C/ ESPALDAR
LAVA MANOS C/ COPETE
HAND WASHBASIN W/ BACK SPLASH
PAG 44



LAVATÓRIO MÉDIO C/ ESPALDAR
LAVABO MEDIO C/ COPETE
WASHBASIN MEDIUM W/ BACK SPLASH
PAG 45



LAVATÓRIO NEO EMBUTIR
LAVABO NEO SOBRE ENCIMERA
EMBEDDED WASHBASIN NEO
PAG 45



SERRAS
PAG 45



LAVATÓRIO NORMAL/MÉDIO
LAVABO NORMAL/MEDIO
WASHBASIN NORMAL/MEDIUM
PAG 44

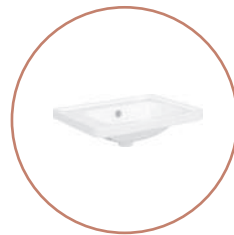

LAVATÓRIO NEO RETANGULAR EMBUTIR
LAVABO SOBRE ENCIMERA NEO RETANGULAR
EMBEDDED RECTANGULAR WASHBASIN NEO
PAG 44



100



SANITA COMPACTA
INODORO P/ TANQUE BAJO
CLOSE COUPLED WC
PAG 48



SANITA SUSPENSA
INODORO SUSPENDIDO
WALL HUNG WC
PAG 49



BIDÉ
BIDÉ
BIDET
PAG 49



BIDÉ SUSPENSO
BIDÉ SUSPENDIDO
WALL HUNG BIDET
PAG 50



LAVATÓRIO POU SAR
LAVABO SOBRE MUEBLE
STANDING WASHBASIN
PAG 51



OPUS



SANITA COMPACTA
INODORO P/ TANQUE BAJO
CLOSE COUPLED WC
PAG 52



SANITA NORMAL
INODORO P/ TANQUE EMPOTRADO
WC CONCEALED
PAG 52



SANITA SUSPENSA
INODORO SUSPENDIDO
WALL HUNG WC
PAG 53



BIDÉ
BIDÉ
BIDET
PAG 53



BIDÉ BTW
BIDÉ BTW
BIDET BTW
PAG 53



BIDÉ SUSPENSO
BIDÉ SUSPENDIDO
WALL HUNG BIDET
PAG 54



LAVATÓRIO MÉDIO/JÚNIOR SUSPENSO
LAVABO MÉDIO/JÚNIOR SUSPENDIDO
WALL HUNG WASHBASIN MEDIUM/JÚNIOR
PAG 55



LAVATÓRIO MÉDIO/JÚNIOR
LAVABO MÉDIO/JÚNIOR
WASHBASIN MEDIUM/JÚNIOR
PAG 54



OCEANUS



SANITA COMPACTA
INODORO P/ TANQUE BAJO
CLOSE COUPLED WC
PAG 57



SANITA SUSPENSA
INODORO SUSPENDIDO
WALL HUNG WC
PAG 58



SANITA NORMAL
INODORO P/ TANQUE EMPOTRADO
WC CONCEALED
PAG 58



BIDÉ
BIDÉ
BIDET
PAG 58



LAV. NORMAL/MÉDIO/JÚNIOR
LAV. NORMAL/MÉDIO/JÚNIOR
NORMAL/MEDIUM/JUNIOR
WASHBASIN
PAG 59



LAV. NORMAL/MÉDIO/JÚNIOR SUSPENSO
LAV. NORMAL/MÉDIO/JÚNIORSUSPENDIDO
NORMAL/MEDIUM/JUNIOR WALL HUNG
WASHBASIN
PAG 60



BIDÉ SUSPENSO
BIDÉ SUSPENDIDO
WALL HUNG BIDET
PAG 59



SANITA COMPACTA V/H

REF

BRANCO
BLANCO
WHITE

CORES STANDARD
COLORES STANDARD
STANDARD COLORS

CORES ESPECIAIS
COLORES ESPECIALES
SPECIAL COLORS

XX=

00

23 / 47 / 48

PÁG. 8

Inodoro p/ tanque baixo V/H
Close coupled WC V/H

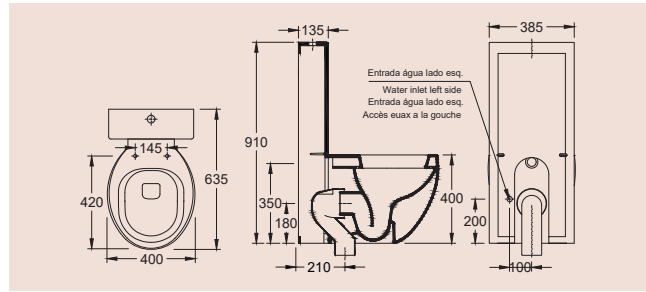

(40x50x40 cm)

39071xx2V

587 €

1.026 €

1.173 €

(40x50x40 cm)

39071xx2H

587 €

1.026 €

1.173 €

**TANQUE CERÂMICO C/
MECANISMO**

Tanque cerâmico con mecanismo
Ceramic cistern with mechanism

(39x14x91 cm)

39142xx2K

462 €

809 €

923 €

SANITA NORMAL BTW V/H

REF

BRANCO
BLANCO
WHITE

CORES STANDARD
COLORES STANDARD
STANDARD COLORS

CORES ESPECIAIS
COLORES ESPECIALES
SPECIAL COLORS

XX=

00

23 / 47 / 48

PÁG. 8

Inodoro p/ tanque empotrado BTW V/H
WC concealed BTW V/H

(40x50x40 cm)

39071xx2K

462 €

809 €

923 €

(40x50x40 cm)

39071xx2W

462 €

809 €

923 €

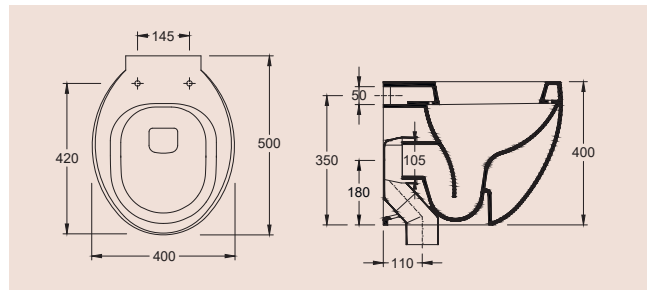

TAMPO SC TAKE-OFF

REF

BRANCO
BLANCO
WHITE

CORES STANDARD
COLORES STANDARD
STANDARD COLORS

CORES ESPECIAIS
COLORES ESPECIALES
SPECIAL COLORS

XX=

00

23 / 47 / 48

PÁG. 8

Tapa SC take-off
Toilet seat SC take-off

50264xx5

132 €

229 €

262 €

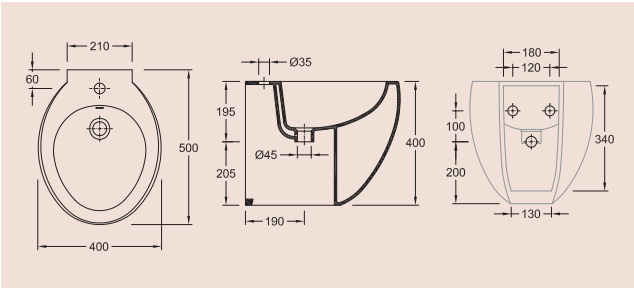

BIDÉ	REF	BRANCO BLANCO WHITE	CORES STANDARD COLORES STANDARD STANDARD COLORS	CORES ESPECIAIS COLORES ESPECIALES SPECIAL COLORS
Bidé Bidet (40x50x40 cm)	39411xx2K	XX= 00	23 / 47 / 48	PÁG. 8
		402 €	704 €	803 €
				

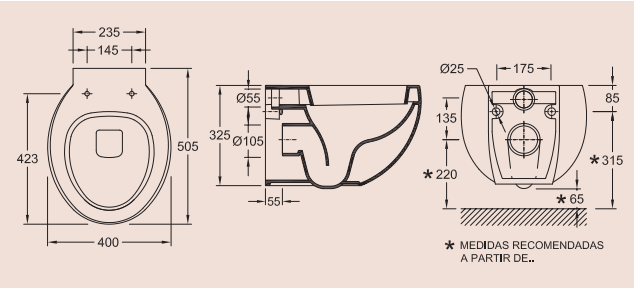

SANITA SUSPENSA	REF	BRANCO BLANCO WHITE	CORES STANDARD COLORES STANDARD STANDARD COLORS	CORES ESPECIAIS COLORES ESPECIALES SPECIAL COLORS
Inodoro suspenso Wall hung WC (40x51x33cm)	39001xx2K	XX= 00	23 / 47 / 48	PÁG. 8
		438 €	765 €	875 €
				



TAMPO SC TAKE-OFF	REF	BRANCO BLANCO WHITE	CORES STANDARD COLORES STANDARD STANDARD COLORS	CORES ESPECIAIS COLORES ESPECIALES SPECIAL COLORS
Tapa SC take-off Toilet seat SC take-off (40x51x33 cm)	50268xx5	XX= 00	23 / 47 / 48	PÁG. 8
		132 €	229 €	262 €
				



LAVATÓRIO POUSAR

REF

BRANCO
BLANCO
WHITE

CORES STANDARD
COLORES STANDARD
STANDARD COLORS

CORES ESPECIAIS
COLORES ESPECIALES
SPECIAL COLORS

XX= 00 23 / 47 / 48 PÁG. 8

Lavabo sobre mueble
Standing washbasin

39357xx2C

194 €

341 €

389 €

(50x38x12 cm)

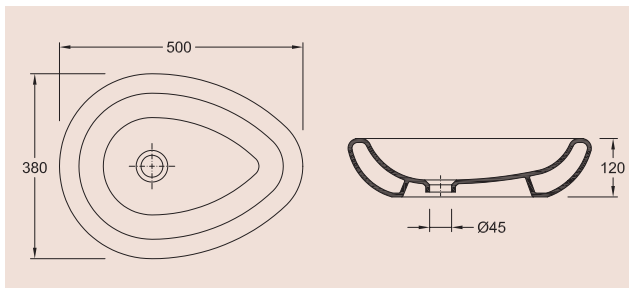

LAVATÓRIO COLUNA INTEGRADA

REF

BRANCO
BLANCO
WHITE

CORES STANDARD
COLORES STANDARD
STANDARD COLORS

CORES ESPECIAIS
COLORES ESPECIALES
SPECIAL COLORS

XX= 00 23 / 47 / 48 PÁG. 8

Lavabo columna
Washbasin with integrated pedestal

39881xx2C

1.184 €

2.073 €

2.369 €

(48x52x90 cm)

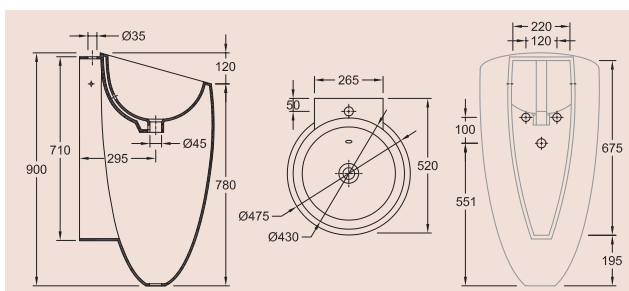

LAVATÓRIO SUSPENSO COLUNA INTEGRADA

REF

BRANCO
BLANCO
WHITE

CORES STANDARD
COLORES STANDARD
STANDARD COLORS

CORES ESPECIAIS
COLORES ESPECIALES
SPECIAL COLORS

XX= 00 23 / 47 / 48 PÁG. 8

Lavabo columna suspenso
Wall hung washbasin with integrated pedestal

39871xx2K

331 €

578 €

659 €

(35x34x59 cm)

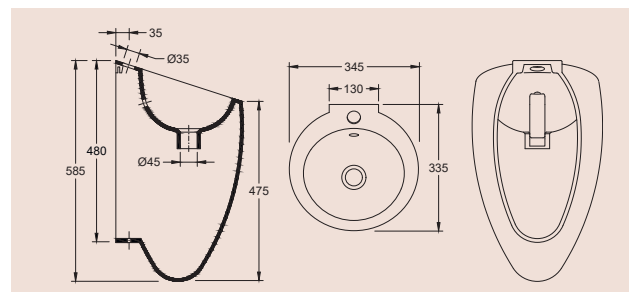

MONOCOMANDO DE LAVATÓRIO EGG SUSPENSO

REF

CROMADO
CROMO
CHROME

NIQUEL ESCOVADO
NIQUEL PULIDO
BRUSHED NICKEL

PRETO MATE
NEGRO MATE
BLACK MATT

X= 2 0 3

Monomando de lavabo EGG suspenso
Single lever washbasin mixer EGG washbasin

5061532x

151 €

227 €

227 €

JUNTA ANTI RUÍDO P/ SANITA SUSPensa (ARTIGO OPCIONAL)	REF	
Junta anti ruido para inodoro suspendido (artículo opcional) Anti noise joint for wall hung WC (optional article)	55034601	13 €
PULSADOR CROMADO P/ MECANISMO	REF	
Pulsador cromo p/ mecanismo Chromed pushbutton for mechanism	55094000	10 €
KIT DE FIXAÇÃO LATERAL	REF	
Kit de fijación lateral Side fixing kit	55185000	7 €
SUPORE DE FIXAÇÃO (LAVATÓRIO SUSPENSO)	REF	
Soporte de fijación (lavabo suspendido) Fixing bracket (wall hung washbasin)	55150210	13 €
CURVA DE DESCARGA VERTICAL (SANITA COMPACTA)	REF	
Curva de descarga vertical (inodoro compacto) Vertical discharge curve (close coupled WC)	55114030	21 €
CURVA DE DESCARGA VERTICAL (SANITA BTW)	REF	
Manguito de descarga vertical (inodoro BTW) Vertical discharge curave (BTW WC)	55114011	21 €
TUBO DE DESCARGA HORIZONTAL 30CM (SANITA COMPACTA)	REF	
Tubo de descarga horizontal 30cm (inodoro compacto) Horizontal discharge tube 30cm (close coupled WC)	55023031	26 €
TUBO DE DESCARGA HORIZONTAL 25CM (SANITA BTW)	REF	
Tubo de descarga horizontal 25cm (inodoro BTW) Horizontal discharge tube 25cm (BTW WC)	55040010	21 €
KIT DE FIXAÇÃO POSTERIOR (SANITA COMPACTA)	REF	
Kit de fijación trasera (inodoro compacto) Rear fixation kit (close coupled WC)	55150180	46 €
KIT DE FIXAÇÃO POSTERIOR (SANITA BTW)	REF	
Kit de fijación trasera (inodoro BTW) Rear fixation kit (BTW WC)	55150190	46 €
KIT FIXAÇÃO (SANITA E BIDÉ SUSPENSOS EGG)	REF	
Kit de fijación (inodoro y bidé suspendidos Egg) Fixing kit (Egg wall hung WC and bidet)	55150200	32 €
TANQUE PLÁSTICO C/ MECANISMO DD	REF	
Tanque plastico c/ mecanismo DD Plastic cistern w/ DD mechanism	55064011	95 €





SANITA COMPACTA HIDE RIMLESS V/H

REF

BRANCO
BLANCO
WHITE

CORES STANDARD
COLORES STANDARD
STANDARD COLORS

CORES ESPECIAIS
COLORES ESPECIALES
SPECIAL COLORS

Inodoro Rimless p/ T.Bajo Hide V/H
Close coupled Rimless Hide WC V/H

XX=

00

23 / 47 / 48

PÁG. 8

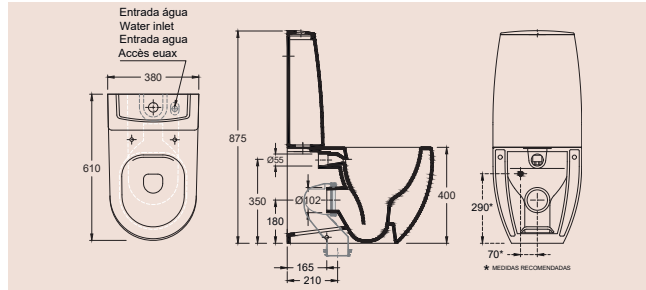

(38x61x40 cm)

34554xx2V

393 €

688 €

784 €

(38x61x40 cm)

34554xx2H

393 €

688 €

784 €

TANQUE CERÂMICO C/ MECANISMO

Tanque cerâmico con mecanismo
Ceramic cistern with mechanism

34192xx2K

190 €

295 €

329 €

TANQUE OPCIONAL

Tanque opcional
Optional cistern
(37x15x48 cm)

34182xx2K

223 €

327 €

361 €

TAMPO TERMODUR SC TAKE-OFF

REF

BRANCO
BLANCO
WHITE

CORES STANDARD
COLORES STANDARD
STANDARD COLORS

CORES ESPECIAIS
COLORES ESPECIALES
SPECIAL COLORS

Tapa termodur SC take-off
Toilet seat SC take-off

XX=

00

23 / 47 / 48

PÁG. 8

50239xx0

82 €

143 €

163 €

TAMPO TERMODUR TAKE-OFF

Tapa termodur take-off
Toilet seat take-off

50235xx0

63 €

123 €

138 €

BIDÉ HIDE

REF

BRANCO
BLANCO
WHITE

CORES STANDARD
COLORES STANDARD
STANDARD COLORS

CORES ESPECIAIS
COLORES ESPECIALES
SPECIAL COLORS

Bidé Hide
Bidet Hide

XX=

00

23 / 47 / 48

PÁG. 8

(37x56x40 cm)

34414xx2K

266 €

466 €

532 €

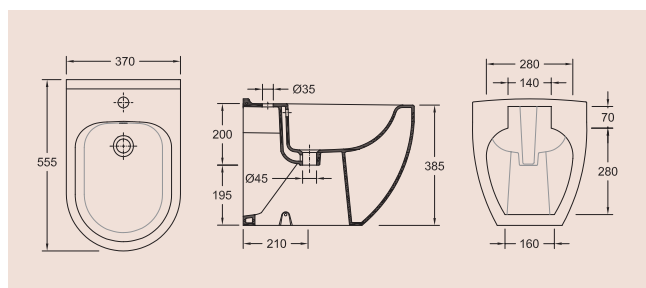



SANITA SUSPENSA HIDE

REF

BRANCO
BLANCO
WHITE

CORES STANDARD
COLORES STANDARD
STANDARD COLORS

CORES ESPECIAIS
COLORES ESPECIALES
SPECIAL COLORS

Inodoro suspendido hide
Wall hung WC Hide

XX=

00

23 / 47 / 48

PÁG. 8

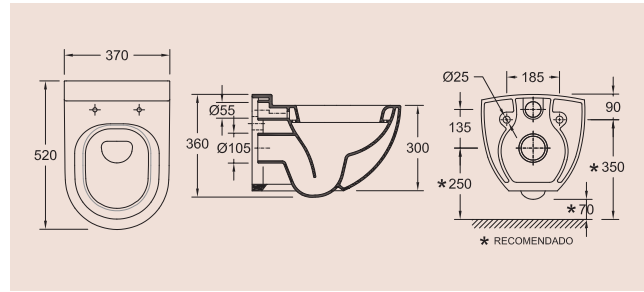

(37x52x36 cm)

34004xx2K

329 €

576 €

658 €

SANITA SUSPENSA HIDE RIMLESS

Inodoro suspendido hide rimless
Wall hung rimless hide WC

(37x52x36 cm)

34504xx2K

354 €

620 €

708 €

TAMPO TERMODUR SC TAKE-OFF

REF

BRANCO
BLANCO
WHITE

CORES STANDARD
COLORES STANDARD
STANDARD COLORS

CORES ESPECIAIS
COLORES ESPECIALES
SPECIAL COLORS

Tapa termodur SC take-off
Toilet seat SC take-off

XX=

00

23 / 47 / 48

PÁG. 8

50239xx0

82 €

143 €

163 €

TAMPO TERMODUR TAKE-OFF

Tapa termodur take-off
Toilet seat take-off

50235xx0

63 €

123 €

138 €

BIDÉ SUSPENSO HIDE

REF

BRANCO
BLANCO
WHITE

CORES STANDARD
COLORES STANDARD
STANDARD COLORS

CORES ESPECIAIS
COLORES ESPECIALES
SPECIAL COLORS

Bidé suspendido hide
Wall hung bidet hide

XX=

00

23 / 47 / 48

PÁG. 8

(38x52x32 cm)

34404xx2K

266 €

466 €

531 €

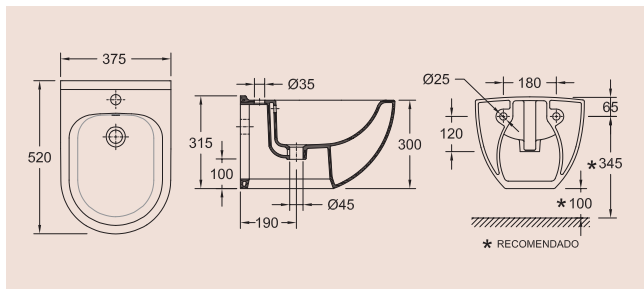

LAVATÓRIO MÉDIO

REF

BRANCO
BLANCO
WHITE

CORES STANDARD
COLORES STANDARD
STANDARD COLORS

CORES ESPECIAIS
COLORES ESPECIALES
SPECIAL COLORS

Lavabo médio
Washbasin medium

XX=

00

23 / 47 / 48

PÁG. 8

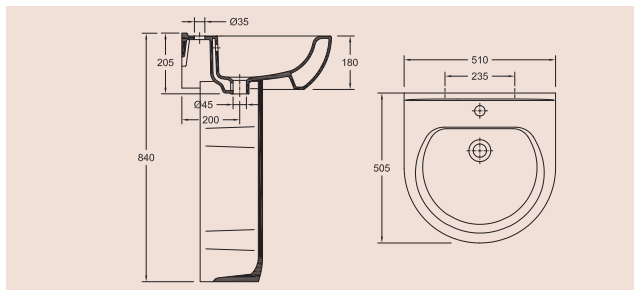

(51x51x21 cm)

34331xx2C

209 €

366 €

418 €

COLUNA

Columna
Pedestal

34200xx2K

139 €

242 €

278 €

LAVATÓRIO MÉDIO SUSPENSO

REF

BRANCO
BLANCO
WHITE

CORES STANDARD
COLORES STANDARD
STANDARD COLORS

CORES ESPECIAIS
COLORES ESPECIALES
SPECIAL COLORS

Lavabo médio suspenso
Wall hung washbasin medium

XX=

00

23 / 47 / 48

PÁG. 8

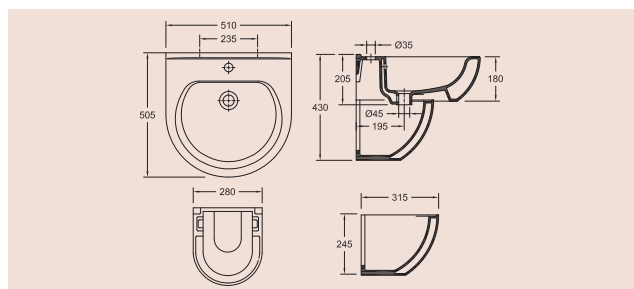

(51x51x20 cm)

34331xx2C

209 €

366 €

418 €

COLUNA SUSPENSA

Columna suspendida
Wall hung pedestal

34220xx2K

133 €

233 €

266 €



JUNTA ANTI RUÍDO P/ SANITA SUSPENSA (ARTIGO OPCIONAL)

REF

Junta anti ruido para inodoro suspendido (artículo opcional)
Anti noise joint for wall hung WC (optional article)

55034602

13 €

PULSADOR CROMADO P/ MECANISMO

REF

Pulsador cromo p/ mecanismo
Chromed pushbutton for mechanism

55040003

14 €

KIT FIXAÇÃO (LAVATÓRIO MÉDIO)

REF

Kit de fijación (lavabo médio)
Fixing kit (medium washbasin)

55007001

6 €

KIT FIXAÇÃO (COLUNA SUSPENSA)

REF

Kit de fijación (columna suspendida)
Fixing kit (wall hung column)

55126010

22 €

KIT FIXAÇÃO LATERAL

REF

Kit de fijación lateral
Side fixing kit

55185030

9 €

CURVA DE DESCARGA VERTICAL (SANITA COMPACTA)

REF

Curva de descarga vertical (inodoro compacto)
Vertical discharge curve (close coupled WC)

55114030

21 €

TUBO DE DESCARGA HORIZONTAL (SANITA COMPACTA)

REF

Tubo de descarga horizontal (inodoro compacto)
Horizontal discharge tube (close coupled WC)

55040010

21 €

KIT DE RETENÇÃO (TANQUE)

REF

Kit de retención (tanque)
Retention kit (cistern)

55150023

14 €

TUBO FLEXÍVEL (TANQUE)

REF

Tubo flexible (tanque)
Flexible pipe (cistern)

55150031

10 €

VÁLVULA DE CORTE (TANQUE)

REF

Válvula de cierre (tanque)
Shut-off valve (cistern)

50679001

20 €

KIT FIXAÇÃO SANITA SUSPENSA

REF

Kit de fijación para inodoro suspendido
Wall hung toilet fixing kit

55150202

22 €

KIT FIXAÇÃO BIDÉ SUSPENSO

REF

Kit de fijación para bidé suspendido
Wall hung bidet fixing kit

55150204

23 €

MECANISMO DD

REF

Mecanismo DD
DD mechanism

50592042

51 €

SANITA COMPACTA V/H

REF

BRANCO
BLANCO
WHITE

CORES STANDARD
COLORES STANDARD
STANDARD COLORS

CORES ESPECIAIS
COLORES ESPECIALES
SPECIAL COLORS

Inodoro para tanque baixo V/H
Close coupled WC V/H

XX=

00

23 / 47 / 48

PÁG. 8

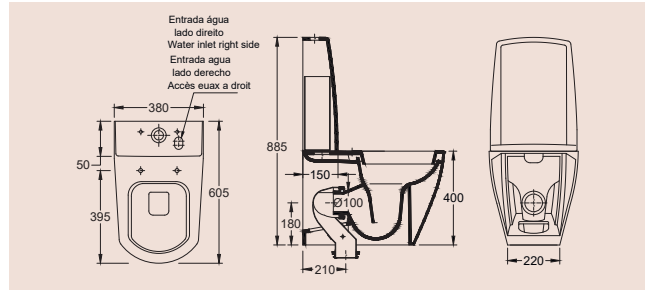

(38x61x40 cm)

40051xx2V

357 €

624 €

713 €

(38x61x40 cm)

40051xx2H

357 €

624 €

713 €

TANQUE CERÂMICO C/ MECANISMO

Tanque cerâmico con mecanismo
Ceramic cistern with mechanism

(38x15x49 cm)

40182xx2K

223 €

327 €

361 €

TAMPO TERMODUR SC TAKE-OFF

REF

BRANCO
BLANCO
WHITE

CORES STANDARD
COLORES STANDARD
STANDARD COLORS

CORES ESPECIAIS
COLORES ESPECIALES
SPECIAL COLORS

Tapa termodur SC take-off
Toilet seat SC take-off

XX=

00

23 / 47 / 48

PÁG. 8

50202xx0

80 €

141 €

160 €

TAMPO TERMODUR TAKE-OFF

Tapa termodur take-off
Toilet seat take-off

50203xx0

63 €

111 €

126 €

BIDÉ

REF

BRANCO
BLANCO
WHITE

CORES STANDARD
COLORES STANDARD
STANDARD COLORS

CORES ESPECIAIS
COLORES ESPECIALES
SPECIAL COLORS

Bidé
Bidet

XX=

00

23 / 47 / 48

PÁG. 8

(36x50x40 cm)

40411xx2K

255 €

447 €

510 €

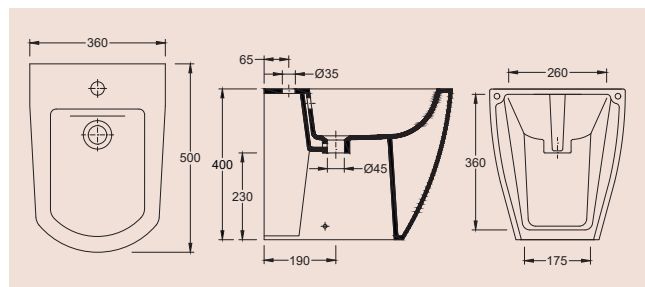

SANITA SUSPENS	REF	BRANCO BLANCO WHITE	CORES STANDARD COLORES STANDARD STANDARD COLORS	CORES ESPECIAIS COLORES ESPECIALES SPECIAL COLORS
Inodoro suspenido Wall hung WC (38x50x35 cm)	40001xx2K	XX= 00	23 / 47 / 48	PÁG. 8 604 €
				302 € 529 €

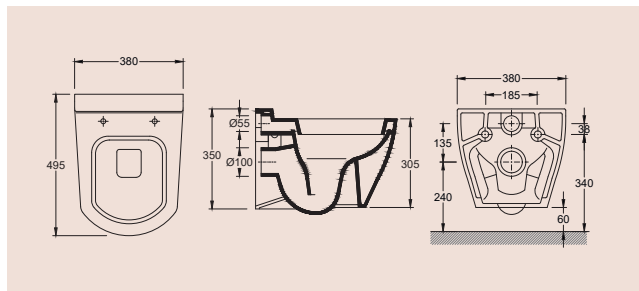

TAMPO TERMODUR SC TAKE-OFF	REF	BRANCO BLANCO WHITE	CORES STANDARD COLORES STANDARD STANDARD COLORS	CORES ESPECIAIS COLORES ESPECIALES SPECIAL COLORS
Tapa termodur SC take-off Toilet seat SC take-off	50202xx0	XX= 00	23 / 47 / 48	PÁG. 8 160 €
				80 € 141 €

TAMPO TERMODUR TAKE-OFF	REF	BRANCO BLANCO WHITE	CORES STANDARD COLORES STANDARD STANDARD COLORS	CORES ESPECIAIS COLORES ESPECIALES SPECIAL COLORS
Tapa termodur take-off Toilet seat take-off	50203xx0	XX= 00	23 / 47 / 48	PÁG. 8 126 €
				63 € 111 €



BIDÉ SUSPENSO	REF	BRANCO BLANCO WHITE	CORES STANDARD COLORES STANDARD STANDARD COLORS	CORES ESPECIAIS COLORES ESPECIALES SPECIAL COLORS
Bidé suspenido Wall hung bidet (36x50x30 cm)	40401xx2K	XX= 00	23 / 47 / 48	PÁG. 8 489 €
				245 € 428 €

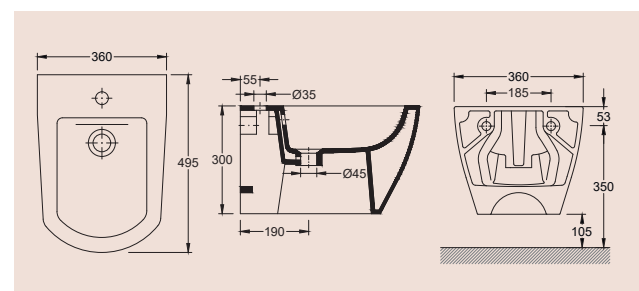

LAVATÓRIO ONE LINE

REF

BRANCO
BLANCO
WHITE

CORES STANDARD
COLORES STANDARD
STANDARD COLORS

CORES ESPECIAIS
COLORES ESPECIALES
SPECIAL COLORS

Lavabo ONE LINE
Washbasin ONE LINE

XX=

00

23 / 47 / 48

PÁG. 8

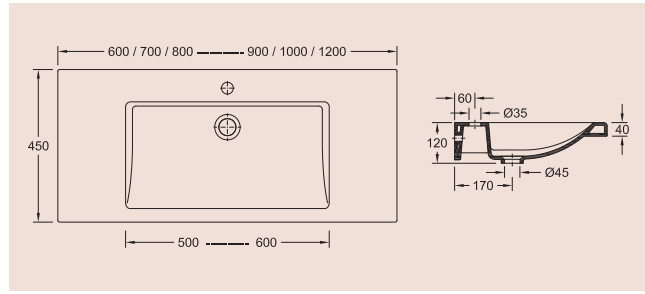

120 (120x45x12 cm)	40331xx2C	423 €	740 €	845 €
100 (100x45x12 cm)	40321xx2C	335 €	587 €	670 €
90 (90x45x12 cm)	40361xx2C	297 €	520 €	594 €
80 (80x45x12 cm)	40311xx2C	264 €	462 €	528 €
70 (70x45x12 cm)	40341xx2C	234 €	410 €	468 €
60 (60x45x12 cm)	40301xx2C	206 €	359 €	411 €

TOALHEIRO ONE LINE

REF

INOX POLIDO
ACERO INOXIDABLE PULIDO
POLISHED STAINLESS STEEL

PRETO
NEGRO
BLACK

Toallero ONE LINE
Towel rail ONE LINE

x = 0

x = 3

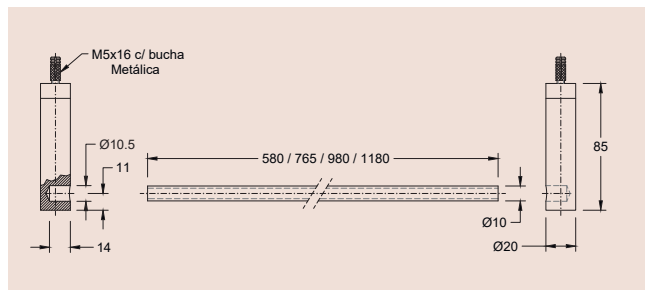

120	5517414x	113 €	169 €
100	5517413x	110 €	165 €
90	5517405x	110 €	165 €
80	5517418x	104 €	156 €
70	5517402x	101 €	151 €
60	5517407x	101 €	151 €

LAVATÓRIO ONE SLIM

REF

BRANCO
BLANCO
WHITE

CORES STANDARD
COLORES STANDARD
STANDARD COLORS

CORES ESPECIAIS
COLORES ESPECIALES
SPECIAL COLORS

Lavabo One Slim
Washbasin One Slim

(47x35x13 cm)

40357xx2C

XX=

00

23 / 47 / 48

PÁG. 8

197 €

344 €

393 €

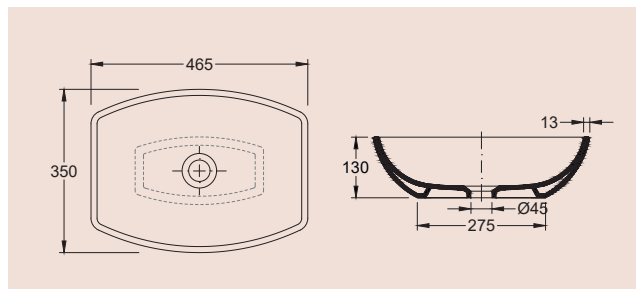

**JUNTA ANTI RÚIDO P/ SANITA SUSPENSA
(ARTIGO OPCIONAL)**
REF

 Junta anti ruido para inodoro suspendido
(artículo opcional)
Anti noise joint for wall hung WC (optional article)

55034603

13 €

PULSADOR CROMADO P/ MECANISMO ONE
REF

 Pulsador cromo p/ mecanismo ONE
Chromed pushbutton for mechanism ONE

55094000

10 €

KIT FIXAÇÃO (LAVATÓRIOS ONE LINE)
REF

 Kit de fijación (lavabos ONE Line)
Fixing kit (ONE Line washbasins)

55007001

6 €

KIT FIXAÇÃO (LAVATÓRIO ONE LINE 80)
REF

 Kit de fijación (lavabo ONE Line 80)
Fixing kit (ONE Line 80 washbasin)

55007320

6 €

KIT FIXAÇÃO LATERAL
REF

 Kit de fijación lateral
Side fixing kit

55185030

9 €

**CURVA DE DESCARGA VERTICAL
(SANITA COMPACTA)**
REF

 Curva de descarga vertical (inodoro compacta)
Vertical discharge curve (close coupled WC)

55114030

21 €

**TUBO DE DESCARGA HORIZONTAL 25CM
(SANITA COMPACTA)**
REF

 Tubo de descarga horizontal 25cm
(inodoro compacta)
Horizontal discharge tube 25cm (close coupled WC)

55040010

21 €

KIT DE RETENÇÃO (TANQUE)
REF

 Kit de retención (tanque)
Retention kit (cistern)

55150021

14 €

TUBO FLEXÍVEL (TANQUE PLÁSTICO)
REF

 Tubo flexible (tanque plástico)
Flexible pipe (plastic cistern)

55150031

10 €

VÁLVULA DE CORTE (TANQUE PLÁSTICO)
REF

 Válvula de cierre (tanque plástico)
Shut-off valve (plastic cistern)

50679001

20 €

KIT FIXAÇÃO SANITA SUSPENSA
REF

 Kit de fijación para inodoro suspendido
Wall hung toilet fixing kit

55150202

22 €

KIT FIXAÇÃO BIDÉ SUSPENSO
REF

 Kit de fijación para bidet suspendido
Wall hung bidet fixing kit

55150204

23 €

TANQUE PLÁSTICO C/ MECANISMO DD
REF

 Tanque plástico c/ mecanismo DD
Plastic cistern w/ DD mechanism

50542031

82 €

SANITA COMPACTA RIMLESS V/H

REF

BRANCO
BLANCO
WHITE

CORES STANDARD
COLORES STANDARD
STANDARD COLORS

Inodoro para tanque baixo Rimless V/H
Close coupled WC Rimless V/H

XX= 00 23 / 47 / 48

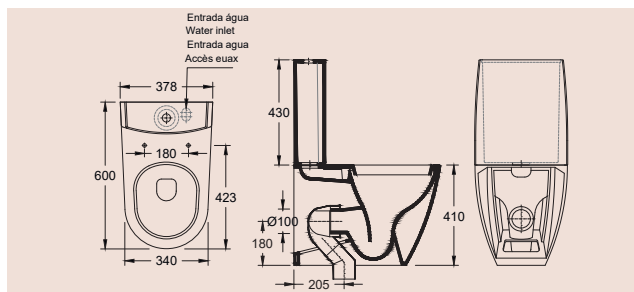

(38x60x41cm)

41551xx2V

260 €

455 €

(38x60x41 cm)

41551xx2H

260 €

455 €

**TANQUE ALIMENTAÇÃO INFERIOR
C/ MECANISMO**

Tanque alimentación inferior
con mecanismo
Bottom inlet cistern with mechanism

(38x13x43 cm)

41182xx2K

154 €

246 €

TAMPO TERMODUR SLIM SC TAKE-OFF

REF

BRANCO
BLANCO
WHITE

CORES STANDARD
COLORES STANDARD
STANDARD COLORS

Tapa termodur slim SC take-off
Toilet seat slim SC take-off

XX= 00 23 / 47 / 48



50204xx0

82 €

141 €

TAMPO TERMODUR SLIM TAKE-OFF

Tapa termodur slim take-off
Toilet seat slim take-off

50205xx0

58 €

107 €

TAMPO TERMODUR SC TAKE-OFF

REF

BRANCO
BLANCO
WHITECORES STANDARD
COLORES STANDARD
STANDARD COLORSTapa termodur SC take-off
Toilet seat SC take-off

XX=

00

23 / 47 / 48



50210xx0

82 €

141 €

TAMPO TERMODUR TAKE-OFFTapa termodur take-off
Toilet seat take-off

50211xx0

58 €

102 €

SANITA NORMAL BTW RIMLESS V/H

REF

BRANCO
BLANCO
WHITECORES STANDARD
COLORES STANDARD
STANDARD COLORSInodoro rimless BTW p/t. empotrado V/H
Normal rimless BTW WC V/H

XX=

00

23 / 47 / 48

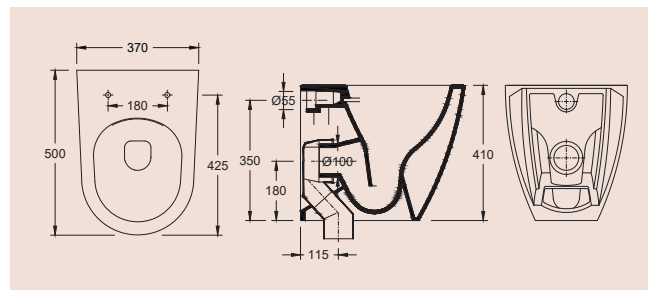

(37x50x41 cm)

41541xx2V

240 €

421 €

(37x50x41 cm)

41541xx2H

240 €

421 €

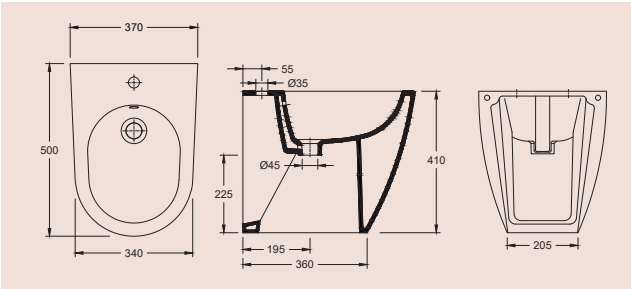

BIDÉ	REF	BRANCO BLANCO WHITE	CORES STANDARD COLORES STANDARD STANDARD COLORS
Bidé Bidet		XX= 00	23 / 47 / 48
(37x50x41 cm)	41411xx2K	188 €	328 €
			

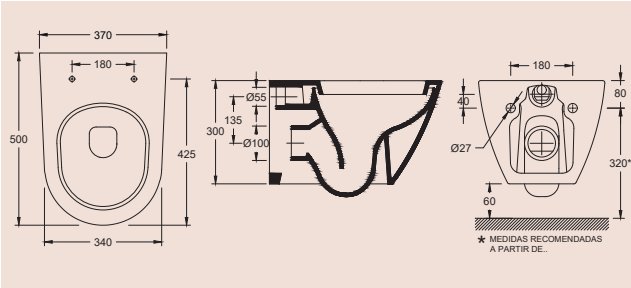

SANITA SUSPensa	REF	BRANCO BLANCO WHITE	CORES STANDARD COLORES STANDARD STANDARD COLORS
Inodoro suspenso Wall hung WC		XX= 00	23 / 47 / 48
			



(37x50x30 cm)	41001xx2K	188 €	328 €
---------------	-----------	-------	-------



SANITA SUSPensa RIMLESS	REF	BRANCO BLANCO WHITE	CORES STANDARD COLORES STANDARD STANDARD COLORS
Inodoro suspenso rimless Wall hung WC rimless		XX= 00	23 / 47 / 48
(37x55x31 cm)	41502xx2K	188 €	328 €
SANITA SUSPensa RIMLESS 55cm		XX= 00	23 / 47 / 48
Inodoro suspenso rimless 55cm Wall hung WC rimless 55cm	41505xx2K	224 €	392 €



TAMPO TERMODUR SLIM SC TAKE-OFF	REF	BRANCO BLANCO WHITE	CORES STANDARD COLORES STANDARD STANDARD COLORS
Tapa termodur slim SC take-off Toilet seat slim SC take-off		XX= 00	23 / 47 / 48
	50204xx0	82 €	141 €
TAMPO TERMODUR SLIM TAKE-OFF		XX= 00	23 / 47 / 48
Tapa termodur slim take-off Toilet seat slim take-off	50205xx0	58 €	107 €



TAMPO TERMODUR SC TAKE-OFF

REF

BRANCO
BLANCO
WHITECORES STANDARD
COLORES STANDARD
STANDARD COLORSTapa termodur SC take-off
Toilet seat SC take-off

XX= 00

23 / 47 / 48



50210xx0

82 €

141 €

TAMPO TERMODUR TAKE-OFFTapa termodur take-off
Toilet seat take-off

50211xx0

58 €

102 €

BIDÉ SUSPENSO

REF

BRANCO
BLANCO
WHITECORES STANDARD
COLORES STANDARD
STANDARD COLORSBidé suspenso
Wall hung bidet

XX= 00

23 / 47 / 48

(37x50x30cm)

41401xx2K

160 €

281 €

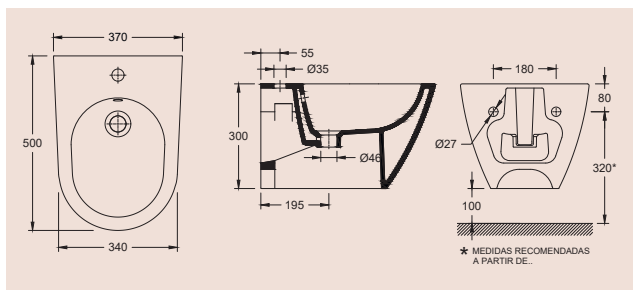

JUNTA ANTI RUÍDO P/ SANITA SUSPENSA (ARTIGO OPCIONAL)			REF
Junta anti ruido para inodoro suspendido (artículo opcional) Anti noise joint for wall hung WC (optional article)	55034600	13 €	
MECANISMO DD			REF
Mecanismo DD DD mechanism	55519020	33 €	
KIT FIXAÇÃO LATERAL			REF
Kit de fijación lateral Side fixing kit	55185030	9 €	
CURVA DE DESCARGA VERTICAL (SANITA COMPACTA)			REF
Curva de descarga vertical (inodoro compacta) Vertical discharge curve (close coupled WC)	55114030	21 €	
CURVA DE DESCARGA VERTICAL (SANITA BTW)			REF
Curva de descarga vertical (inodoro BTW) Vertical discharge curve (BTW WC)	55114011	21 €	
TUBO DE DESCARGA HORIZONTAL 25CM (SANITA COMPACTA)			REF
Tubo de descarga horizontal 25cm (inodoro compacta) Horizontal discharge tube 25cm (close coupled WC)	55040010	21 €	
KIT DE RETENÇÃO (TANQUE)			REF
Kit de retención (tanque) Retention kit (cistern)	55150023	14 €	
TUBO FLEXÍVEL (TANQUE)			REF
Tubo flexible (tanque) Flexible pipe (cistern)	55150031	10 €	
VÁLVULA DE CORTE (TANQUE)			REF
Válvula de cierre (tanque) Shut-off valve (cistern)	50679001	20 €	



KIT FIXAÇÃO SANITA SUSPENSA

REF

Kit de fijación para inodoro suspendido
Wall hung toilet fixing kit

55150202

22 €

KIT FIXAÇÃO BIDÉ SUSPENSO

REF

Kit de fijación para bidé suspendido
Wall hung bidet fixing kit

55150204

23 €

EMBOQUE (SANITA SUSPENSA RIMLESS)

REF

Conexión (inodoro suspendido rimless)
Rubber connection (wall hung rimless WC)

55005030

6 €

**REDUTOR DE CAUDAL
(SANITA SUSPENSA RIMLESS)**

REF

Reductor de flujo (inodoro suspendido
rimless)
Flow reducer (wall hung rimless WC)

50649020

6 €



SANITA SUSPENSA	REF	BRANCO BLANCO WHITE	CORES STANDARD COLORES STANDARD STANDARD COLORS	CORES ESPECIAIS COLORES ESPECIALES SPECIAL COLORS
-----------------	-----	---------------------------	---	---

Inodoro Suspendido
Wall hung WC

XX= 00 23 / 47 / 48 PÁG. 8

(39x56x33 cm)

36001xx2K

262 €

458 €

521 €

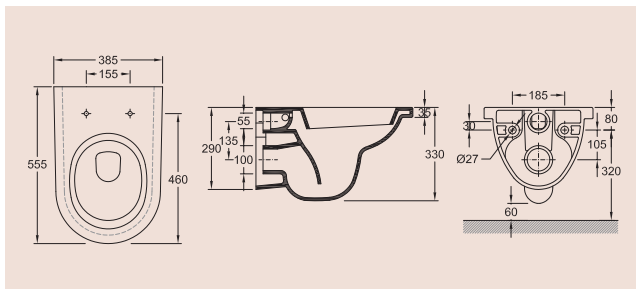

TAMPO CM SC TAKE-OFF	REF	BRANCO BLANCO WHITE	CORES STANDARD COLORES STANDARD STANDARD COLORS	CORES ESPECIAIS COLORES ESPECIALES SPECIAL COLORS
----------------------	-----	---------------------------	---	---

Tapa CM SC take-off
Toilet seat CM SC take-off

XX= 00 23 / 47 / 48 PÁG. 8

50243xx0

138 €

240 €

276 €

TAMPO CM

Tapa CM
Toilet seat CM

50242xx0

108 €

189 €

215 €



SIFÃO LIGHT	REF	CROMADO CROMO CHROME
-------------	-----	----------------------------

Sifón Light
Light Siphon

55109152

63 €

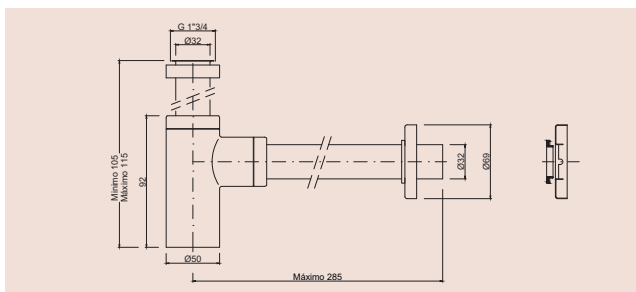

BIDÉ SUSPENSO

REF

BRANCO
BLANCO
WHITE

CORES STANDARD
COLORES STANDARD
STANDARD COLORS

CORES ESPECIAIS
COLORES ESPECIALES
SPECIAL COLORS

Bidé suspenso
Wall hung bidet

XX=

00

23 / 47 / 48

PÁG. 8

(39x56x23 cm)

36401xx2K

184 €

322 €

367 €

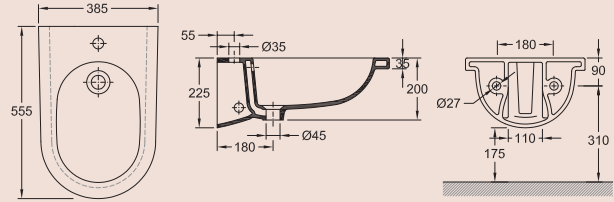

LAVATÓRIO MÉDIO

REF

BRANCO
BLANCO
WHITE

CORES STANDARD
COLORES STANDARD
STANDARD COLORS

CORES ESPECIAIS
COLORES ESPECIALES
SPECIAL COLORS

Lavabo médio
Washbasin medium

XX=

00

23 / 47 / 48

PÁG. 8

(55x45x18 cm)

36331xx2C

169 €

295 €

338 €

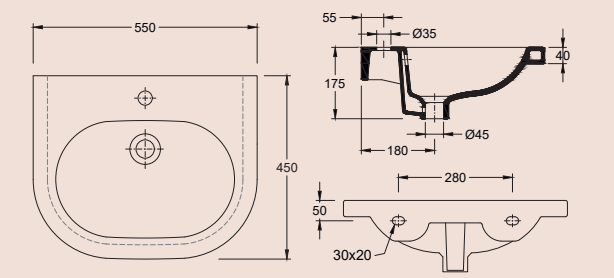

SANITA COMPACTA V/H

REF

BRANCO
BLANCO
WHITE

CORES STANDARD
COLORES STANDARD
STANDARD COLORS

CORES ESPECIAIS
COLORES ESPECIALES
SPECIAL COLORS

Inodoro compacto V/H
Close coupled WC V/H

XX=

00

23 / 47 / 48

PÁG. 8

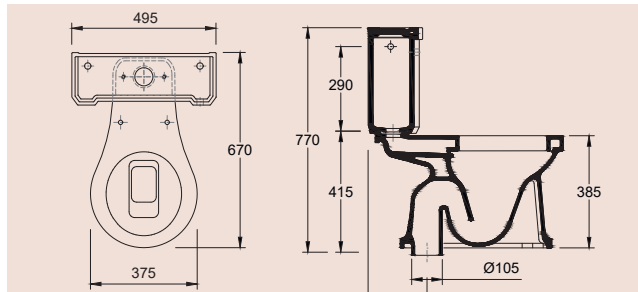

(38x67x39 cm) **V** 16024xx2K

287 €

504 €

573 €

(38x67x39 cm) **H** 16021xx2K

287 €

504 €

573 €

**TANQUE ALIMENTAÇÃO INFERIOR
C/ MECANISMO**

Tanque alimentación inferior con
mecanismo
Bottom inlet cistern with mechanism

(50x18x37 cm) 16163xx2K

281 €

451 €

528 €

**TANQUE ALIMENTAÇÃO LATERAL
C/ MECANISMO**

Tanque alimentación lateral con
mecanismo
Side inlet cistern with
mechanism

(50x18x37 cm) 16161xx2K

281 €

451 €

528 €

TAMPO CM SC TAKE-OFF

REF

BRANCO
BLANCO
WHITE

CORES STANDARD
COLORES STANDARD
STANDARD COLORS

CORES ESPECIAIS
COLORES ESPECIALES
SPECIAL COLORS

MADEIRA
MADERA
WOOD

Tapa CM SC take-off
Toilet seat CM SC take-off
hinges

XX=

00

23 / 47 / 48

PÁG. 8

22 / 72

50376xx0

125 €

218 €

249 €

187 €

TAMPO CM

Tapa CM
Toilet seat CM

50343xx0

98 €

171 €

196 €

125 €

Cores : "00" - branco/ "48" - preto/ "72" - castanho/ "22" - carvalho
Colores: "00" - blanco/ "48" - negro/ "72" - marron/ "22" - roble
Colors: "00" - white/ "48" - black/ "72" - brown/ "22" - oak





BIDÉ

REF

BRANCO
BLANCO
WHITE

CORES STANDARD
COLORES STANDARD
STANDARD COLORS

CORES ESPECIAIS
COLORES ESPECIALES
SPECIAL COLORS

Bidé
Bidet

XX=

00

23 / 47 / 48

PÁG. 8

(35x60x38 cm)

16411xx2K

241 €

422 €

482 €

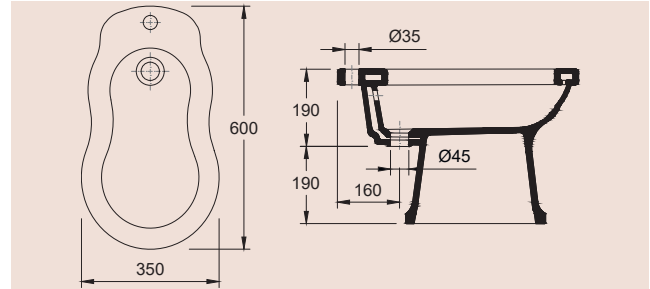

SANITA NORMAL V

REF

BRANCO
BLANCO
WHITE

CORES STANDARD
COLORES STANDARD
STANDARD COLORS

CORES ESPECIAIS
COLORES ESPECIALES
SPECIAL COLORS

Inodoro p/ tanque empotrado / alto V
WC concealed V

XX=

00

23 / 47 / 48

PÁG. 8

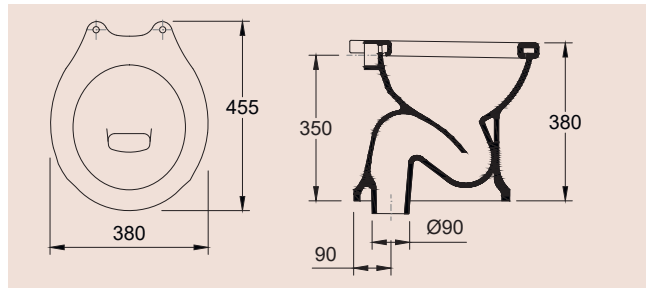

(38x46x38 cm)

16014xx2K

241 €

422 €

482 €

SANITA NORMAL H

Inodoro p/ tanque empotrado / alto H
WC concealed H

(38x46x38 cm)

16011xx2K

241 €

422 €

482 €

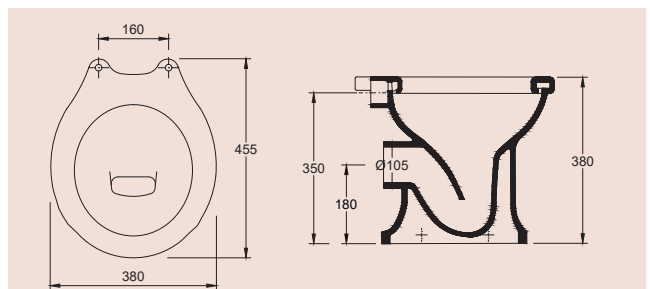

TANQUE ALIMENTAÇÃO INFERIOR C/ MECANISMO REF

Tanque alimentación inferior con mecanismo
Bottom inlet cistern with mechanism

(50x18x37 cm) 16163xx2SK

BRANCO
BLANCO
WHITE

XX= 00

CORES STANDARD
COLORES STANDARD
STANDARD COLORS

23 / 47 / 48

CORES ESPECIAIS
COLORES ESPECIALES
SPECIAL COLORS

PÁG. 8

330 €

501 €

578 €

TANQUE ALTO C/ MECANISMO

Tanque alto con mecanismo
High level cistern with mechanism

(50x18x37 cm) 16131xx2K

432 €

612 €

684 €

TAMPO CM SC TAKE-OFF REF

Tapa CM SC take-off
Toilet seat CM SC take-off hinges

50377xx0

XX= 00

23 / 47 / 48

PÁG. 8

22 / 72

125 €

218 €

249 €

187 €

TAMPO CM

Tapa CM
Toilet seat CM

50344xx0

98 €

171 €

196 €

125 €

Cores: "00" - branco/ "48" - preto/ "72" - castanho/ "22" - carvalho
Colores: "00" - blanco/ "48" - negro/ "72" - marron/ "22" - roble
Colors: "00" - white/ "48" - black/ "72" - brown/ "22" - oak

SANITA NORMAL BTW H/V ALIMENTAÇÃO TRASEIRA REF

Inodoro p/ tanque empotrado
BTW alimentación trasera H/V
Rear inlet WC concealed BTW H/V



BRANCO
BLANCO
WHITE

XX= 00

CORES STANDARD
COLORES STANDARD
STANDARD COLORS

23 / 47 / 48

CORES ESPECIAIS
COLORES ESPECIALES
SPECIAL COLORS

PÁG. 8

396 €

693 €

792 €

VERTICAL

(50x33x22 cm) 16071xx2V

HORIZONTAL

(50x33x22 cm) 16071xx2H

396 €

693 €

792 €

SANITA NORMAL BTW H/V ALIMENTAÇÃO SUPERIOR

Inodoro p/ tanque empotrado
BTW alimentación superior H/V
Top inlet WC concealed BTW H/V

VERTICAL

(50x33x22 cm) 16070xx2V

HORIZONTAL

(50x33x22 cm) 16070xx2H

396 €

693 €

792 €

396 €

693 €

792 €

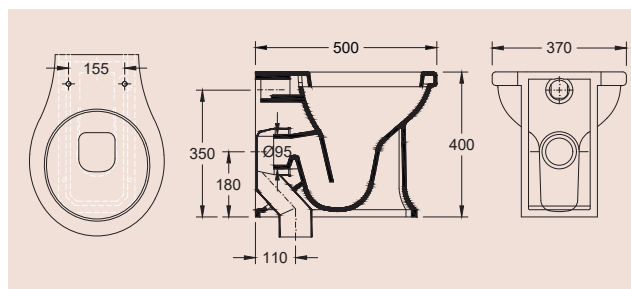

**TANQUE ALTO C/
MECANISMO P/ BTW
DUAL ALIM. SUPERIOR**

REF

BRANCO
BLANCO
WHITE

CORES STANDARD
COLORES STANDARD
STANDARD COLORS

CORES ESPECIAIS
COLORES ESPECIALES
SPECIAL COLORS

Tanque Alto c/ Mecanismo p/
BTW Dual Alim. Superior
High Level Cistern w/
Mechanism f/ BTW Dual
Top Inlet

16131xx2SK

XX= 00 23 / 47 / 48 PÁG. 8

432 € 612 € 684 €

Inodoro p/ tanque
empotrado BTW H
WC concealed BTW H

(37x50x40cm)

16041xx2K

XX= 00 23 / 47 / 48 PÁG. 8

377 € 662 € 755 €

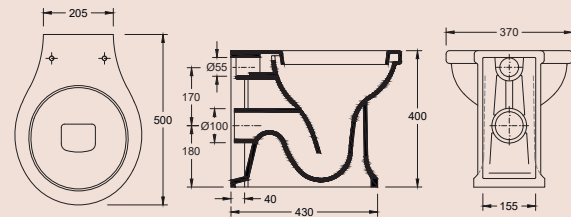

TAMPO CM SC TAKE-OFF

REF

BRANCO
BLANCO
WHITE

CORES STANDARD
COLORES STANDARD
STANDARD COLORS

CORES ESPECIAIS
COLORES ESPECIALES
SPECIAL COLORS

MADEIRA
MADERA
WOOD

Tapa CM SC take-off
Toilet seat CM SC take-off
hinges

50377xx0

XX= 00 23 / 47 / 48 PÁG. 8 22 / 72

125 € 218 € 249 € 187 €

TAMPO CM

Tapa CM
Toilet seat CM

50344xx0

98 € 171 € 196 € 125 €

Cores: "00" - branco/ "48" - preto/ "72" - castanho/ "22" - carvalho
Colores: "00" - blanco/ "48" - negro/ "72" - marron/ "22" - roble
Colors: "00" - white/ "48" - black/ "72" - brown/ "22" - oak

BIDÉ BTW

REF

BRANCO
BLANCO
WHITE

CORES STANDARD
COLORES STANDARD
STANDARD COLORS

CORES ESPECIAIS
COLORES ESPECIALES
SPECIAL COLORS

Bidé BTW
Bidet BTW

(37x50x40 cm)

16441xx2K

XX= 00 23 / 47 / 48 PÁG. 8

331 € 581 € 662 €

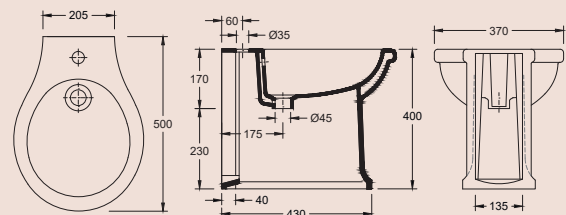

SANITA SUSPENSA **REF** **BRANCO BLANCO WHITE** **CORES STANDARD COLORES STANDARD STANDARD COLORS** **CORES ESPECIAIS COLORES ESPECIALES SPECIAL COLORS**

Inodoro suspenso
Wall hung WC

(37x50x30 cm)

16001xx2K

XX= 00

23 / 47 / 48

PÁG. 8

482 €

844 €

964 €

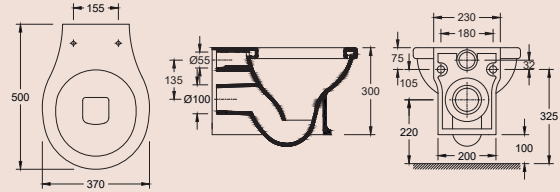

TAMPO CM SC TAKE-OFF **REF** **BRANCO BLANCO WHITE** **CORES STANDARD COLORES STANDARD STANDARD COLORS** **CORES ESPECIAIS COLORES ESPECIALES SPECIAL COLORS** **MADEIRA MADERA WOOD**

Tapa CM SC take-off
Toilet seat CM SC take-off hinges

50376xx0

XX= 00

23 / 47 / 48

PÁG. 8

22 / 72

125 €

218 €

249 €

187 €

TAMPO CM

Tapa CM
Toilet seat CM

50343xx0

98 €

171 €

196 €

125 €

Cores: "00" - branco/ "48" - preto/ "72" - castanho/ "22" - carvalho
Colores: "00" - blanco/ "48" - negro/ "72" - marron/ "22" - roble
Colors: "00" - white/ "48" - black/ "72" - brown/ "22" - oak



BIDÉ SUSPENSO **REF** **BRANCO BLANCO WHITE** **CORES STANDARD COLORES STANDARD STANDARD COLORS** **CORES ESPECIAIS COLORES ESPECIALES SPECIAL COLORS**

Bidé suspenso
Wall hung bidet

(37x50x30 cm)

16401xx2K

XX= 00

23 / 47 / 48

PÁG. 8

377 €

662 €

754 €

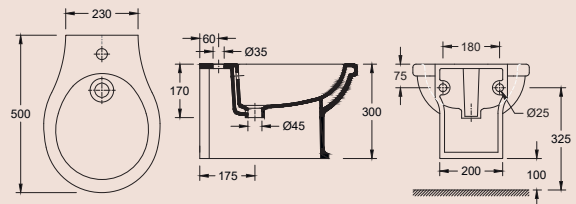

LAVATÓRIO NORMAL

REF

BRANCO
BLANCO
WHITE

CORES STANDARD
COLORES STANDARD
STANDARD COLORS

CORES ESPECIAIS
COLORES ESPECIALES
SPECIAL COLORS

Lavabo normal
Washbasin normal

XX=

00

23 / 47 / 48

PÁG. 8

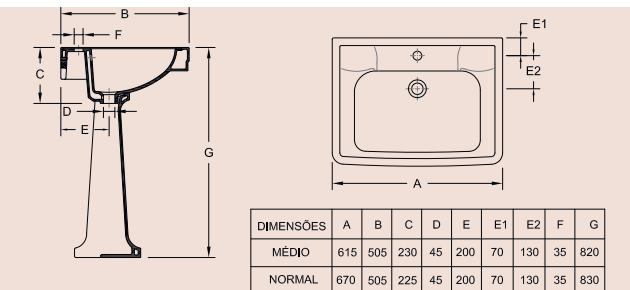

(67x51x23 cm)

16321xx2C

188 €

328 €

376 €

LAVATÓRIO MÉDIO

Lavabo médio
Washbasin medium
(62x51x23 cm)

16331xx2C

156 €

274 €

312 €

COLUNA

Columna
Pedestal

16200xx2K

142 €

246 €

284 €

LAVATÓRIO RETANGULAR DE EMBUTIR

REF

BRANCO
BLANCO
WHITE

CORES STANDARD
COLORES STANDARD
STANDARD COLORS

CORES ESPECIAIS
COLORES ESPECIALES
SPECIAL COLORS

Lavabo sobre encimera retangular
Embedded rectangular washbasin
(60x47x4 cm)

XX=

00

23 / 47 / 48

PÁG. 8

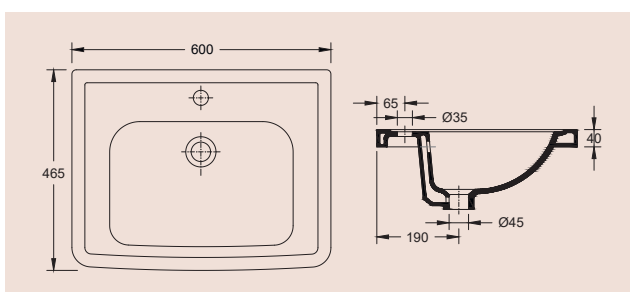

(60x47x4 cm)

16381xx2C

377 €

660 €

755 €

LAVA MÃOS C/ ESPALDAR 1 F.

REF

BRANCO
BLANCO
WHITE

CORES STANDARD
COLORES STANDARD
STANDARD COLORS

CORES ESPECIAIS
COLORES ESPECIALES
SPECIAL COLORS

Lava manos c/ copete 1 orifício
Hand washbasin w/ back splash 1 hole
(50x33x22 cm)

XX=

00

23 / 47 / 48

PÁG. 8

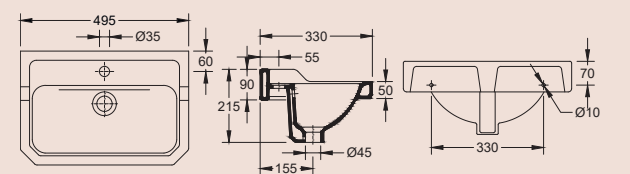

(50x33x22 cm)

16361xx2C

142 €

246 €

284 €

LAVATÓRIO MÉDIO C/ ESPALDAR

REF

BRANCO
BLANCO
WHITE

CORES STANDARD
COLORES STANDARD
STANDARD COLORS

CORES ESPECIAIS
COLORES ESPECIALES
SPECIAL COLORS

Lavabo médio con copete
Washbasin medium w/ back splash

XX=

00

23 / 47 / 48

PÁG. 8

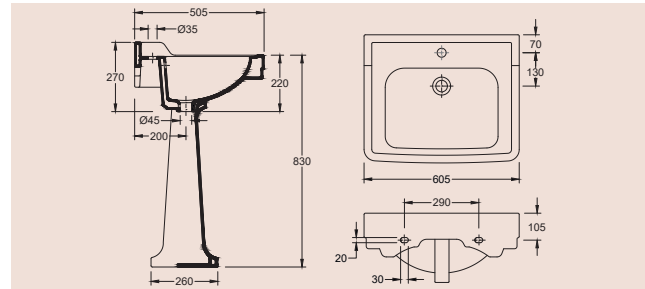

(61x51x27 cm)

16351xx2C

249 €

435 €

498 €

COLUNA

Columna
Pedestal

16200xx2K

142 €

246 €

284 €

LAVATÓRIO REDONDO DE EMBUTIR

REF

BRANCO
BLANCO
WHITE

CORES STANDARD
COLORES STANDARD
STANDARD COLORS

CORES ESPECIAIS
COLORES ESPECIALES
SPECIAL COLORS

Lavabo sobre encimera
redondo
Embedded round
washbasin
(Ø 45 cm)

XX=

00

23 / 47 / 48

PÁG. 8

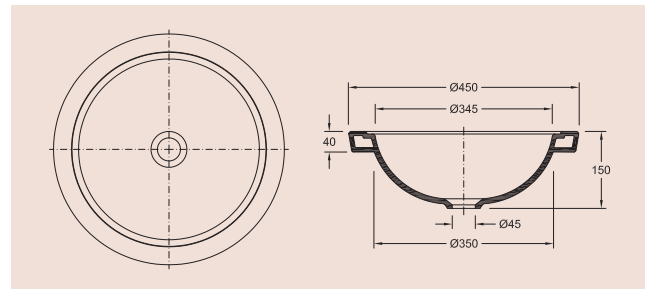

(Ø 45 cm)

16387xx2C

377 €

660 €

754 €

LAVATÓRIO SERRAS

REF

BRANCO
BLANCO
WHITE

CORES STANDARD
COLORES STANDARD
STANDARD COLORS

CORES ESPECIAIS
COLORES ESPECIALES
SPECIAL COLORS

Lavabo Serras
Washbasin Serras

XX=

00

23 / 47 / 48

PÁG. 8

(Ø 40 cm)

78840xx2C

260 €

455 €

519 €

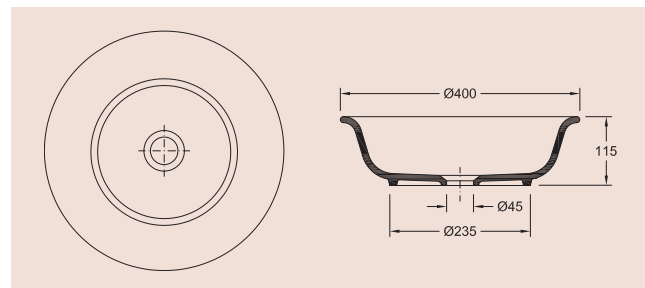

KIT FIXAÇÃO (LAVATÓRIOS)

REF

Kit de fijación nº1 (lavabos)
Fixing kit nº1 (washbasin)

55007001

6 €

KIT FIXAÇÃO (SANITAS E BIDÉS)

REF

Kit de fijación nº3 (inodoros y bidés)
Fixing kit nº3 (WC and bidets)

55007003

6 €

PRATELEIRA CERÂMICA P/ ESTRUTURA DE LAVATÓRIO SERRAS

REF

BRANCO
BLANCO
WHITE

CORES STANDARD
COLORES STANDARD
STANDARD COLORS

CORES ESPECIAIS
COLORES ESPECIALES
SPECIAL COLORS

Estante de cerâmica para estrutura de lavabo Serras
Ceramic Shelf for Serras washbasin structure

21500xx2

XX=

00

23 / 47 / 48

PÁG. 8

74 €

129 €

147 €

TUBO DE DESCARGA HORIZONTAL 25CM (SANITA BTW)

REF

Tubo de descarga horizontal 25cm (inodoro BTW)
Horizontal discharge tube 25cm(BTW WC)

55040010

21 €

MANÍPULO FRONTAL CERÂMICO

REF

BRANCO
BLANCO
WHITE

CORES STANDARD
COLORES STANDARD
STANDARD COLORS

CORES ESPECIAIS
COLORES ESPECIALES
SPECIAL COLORS

Palanca frontal en cerâmica
Ceramic front handle

51004xx2

XX=

00

23 / 47 / 48

PÁG. 8

59 €

102 €

118 €

MECANISMO COMPACTO ENTRADA INFERIOR S/ MANÍPULO

REF

Mecanismo compacto de entrada inferior sin palanca
Mechanism f/ close coupled WC, bottom inlet, without handle

55503000

32 €

MECANISMO COMPACTO ENTRADA LATERAL S/ MANÍPULO

REF

Mecanismo compacto de entrada lateral sin palanca
Mechanism f/ close coupled WC, side inlet, without handle

55504000

32 €

MECANISMO NORMAL ENTRADA INFERIOR S/ MANÍPULO

REF

Mecanismo normal de entrada inferior sin palanca
Mechanism f/ close normal WC, bottom inlet, without handle

55500000

43 €

PUXADOR CERÂMICO P/ TANQUE ALTO

REF

BRANCO
BLANCO
WHITE

CORES STANDARD
COLORES STANDARD
STANDARD COLORS

CORES ESPECIAIS
COLORES ESPECIALES
SPECIAL COLORS

Tirador de cerâmica para tanque alto
Ceramic handle for high level cistern

51006xx2

XX=

00

23 / 47 / 48

PÁG. 8

30 €

54 €

60 €

MECANISMO P/ TANQUE ALTO S/ PUXADOR CERÂMICO

REF

Mecanismo para tanque alto sin tirador cerámico
Mechanism for high level cistern without ceramic handle

50591000

156 €

MECANISMO P/ TANQUE ALTO S/ TUBO

REF

Mecanismo para tanque alto sin tubo
Mechanism for high level cistern w/o tube

50591011

57 €



TUBO CROMADO P/ MECANISMO DE TANQUE ALTO

REF

Tubo cromado para mecanismo de tanque alto
Chrome tube for high level cistern mechanism

55112001

182 €



MECANISMO COMPACTO ALIMENTAÇÃO INFERIOR C/ MANÍPULO FRONTAL CERÂMICO

REF

BRANCO
BLANCO
WHITE

Mecanismo compacto alimentación inferior c/ manípulo cerámica
Mechanism for close coupled WC, bottom inlet w/ ceramic frontal handle

55503001

89 €



MECANISMO COMPACTO ALIMENTAÇÃO LATERAL C/ MANÍPULO FRONTAL CERÂMICO

REF

BRANCO
BLANCO
WHITE

Mecanismo compacto alimentación lateral c/ palanca cerámica
Mechanism for close coupled WC, side inlet w/ ceramic frontal handle

55503002

89 €



MECANISMO NORMAL ALIMENTAÇÃO INFERIOR C/ MANÍPULO FRONTAL CERÂMICO

REF

BRANCO
BLANCO
WHITE

Mecanismo normal alimentación inferior con manípulo en cerámica
Mechanism for concealed WC w/ bottom inlet and frontal ceramic handle

55500001

129 €



MECANISMO P/ TANQUE ALTO COM PUXADOR CERÂMICO

REF

BRANCO
BLANCO
WHITE

Mecanismo tanque alto con tirador cerámico
Mechanism for high level cistern, with ceramic handle

50591001

234 €



SIFÃO DE GARRAFA

REF

CROMADO
CROMO
CHROME

Sifón
Siphon

55109162

22 €

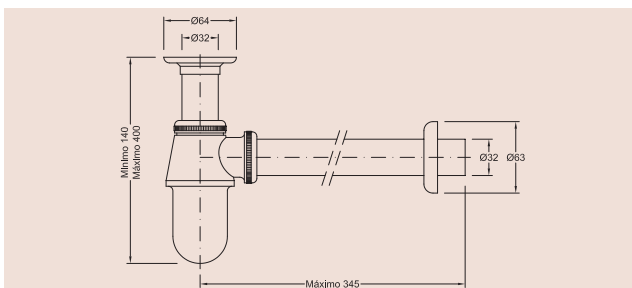

SANITA COMPACTA RIMLESS V/H

REF

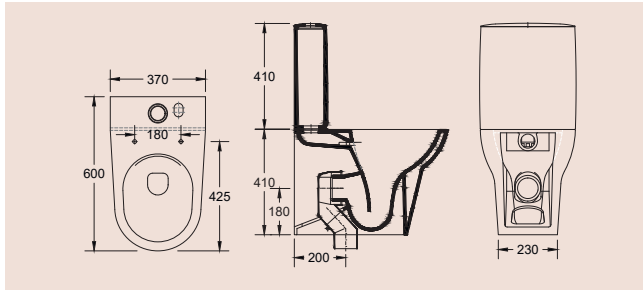
BRANCO
BLANCO
WHITEInodoro p/ tanque baixo rimless V/H
Close coupled WC rimless V/H

(37x60x41 cm)

42551002V

212 €

(37x60x41 cm)

42551002H

212 €

**TANQUE DE ALIMENTAÇÃO
INFERIOR C/ MECANISMO**Tanque alimentación inferior con mecanismo
Bottom inlet cistern with mechanism

(37x13x41 cm)

42182002K

116 €

TAMPO TERMODUR SC TAKE-OFF

REF

BRANCO
BLANCO
WHITETapa termodur SC take-off
Toilet seat SC take-off

50210000

82 €

TAMPO TERMODUR TAKE-OFFTapa termodur take-off
Toilet seat take-off

50211000

58 €

TAMPO TERMODUR SLIM SC TAKE-OFF

REF

BRANCO
BLANCO
WHITE

Tapa termodur slim SC take-off
Toilet seat slim SC take-off



50204000

82 €

TAMPO TERMODUR SLIM TAKE-OFF

Tapa termodur slim take-off
Toilet seat slim take-off

50205000

58 €

BIDÉ

REF

BRANCO
BLANCO
WHITE

Bidé
Bidet

(37x50x41 cm)

42411002K

145 €

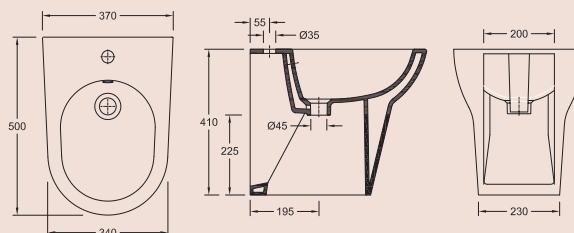

SANITA SUSPENSA RIMLESS

REF

BRANCO
BLANCO
WHITE

Inodoro suspenso rimless
Wall hung WC rimless

(37x50x35 cm)

42501002K

151 €

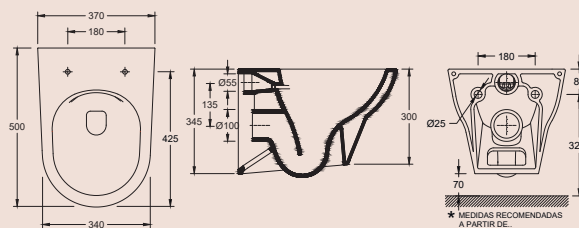

TAMPO TERMODUR SC TAKE-OFF

REF

BRANCO
BLANCO
WHITETapa termodur SC take-off
Toilet seat SC take-off

50210000

82 €

TAMPO TERMODUR TAKE-OFFTapa termodur take-off
Toilet seat take-off

50211000

58 €

TAMPO TERMODUR SLIM SC TAKE-OFF

REF

BRANCO
BLANCO
WHITETapa termodur slim SC take-off
Toilet seat slim SC take-off

50204000

82 €

TAMPO TERMODUR SLIM TAKE-OFFTapa termodur slim take-off
Toilet seat slim take-off

50205000

58 €

BIDÉ SUSPENSO

REF

BRANCO
BLANCO
WHITEBidé suspenso
Wall hung bidet

(37x50x33 cm)

42401002K

127 €

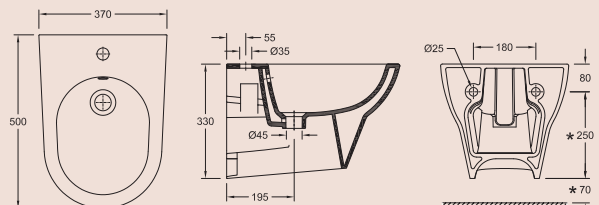
* MEDIDAS RECOMENDADAS
A PARTIR DE...



MECANISMO DD REF BRANCO BLANCO WHITE

Mecanismo DD
DD mechanism

55519032

33 €

LAVATÓRIO DE POUSAR REF BRANCO BLANCO WHITE

Lavabo sobre mueble
Standing washbasin

42350002C

193 €

(Ø 40 cm)

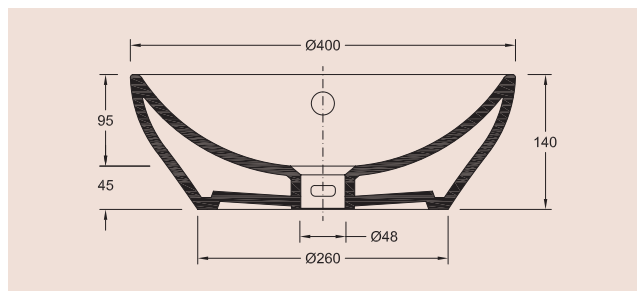

PACK 100 SANITA SUSPENSA RIMLESS, TAMPO SC REF BRANCO BLANCO WHITE

Pack 100 Inodoro Suspendido
Rimless, Tapa SC
Pack 100 Wall Hung WC
Rimless, Toilet Seat SC

42501002KT

230 €



Também disponíveis com descarga horizontal e alimentação lateral
Tambien disponibles con descarga horizontal y alimentación lateral
Also available with horizontal discharge and side inlet mechanism

PACK 100 SANITA SUSPENSA RIMLESS, TAMPO REF BRANCO BLANCO WHITE

Pack 100 Inodoro Suspendido
Rimless, Tapa
Pack 100 Wall Hung WC
Rimless, Toilet seat

42501002KN

206 €

SANITA COMPACTA V/H

REF

BRANCO
BLANCO
WHITE

Inodoro p/ tanque baixo V/H
Close coupled WC V/H

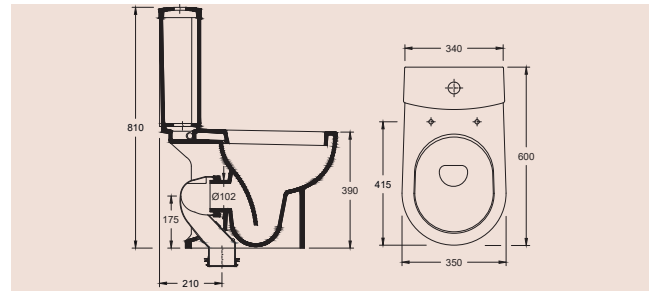

(35x60x39 cm)

37051002V

133 €

(35x60x39 cm)

37051002H

133 €

TANQUE ALIMENTAÇÃO INFERIOR C/ MECANISMO

Tanque alimentación inferior con mecanismo
Bottom inlet cistern with mechanism

(32x15x40 cm)

37182002K

100 €

TANQUE ALIMENTAÇÃO LATERAL C/ MECANISMO

Tanque alimentación lateral con mecanismo
Side inlet cistern with mechanism

(32x15x40 cm)

37181002K

100 €

SANITA NORMAL BTW V/H

REF

BRANCO
BLANCO
WHITE

Inodoro p/ tanque empotrado BTW V/H
WC concealed BTW V/H

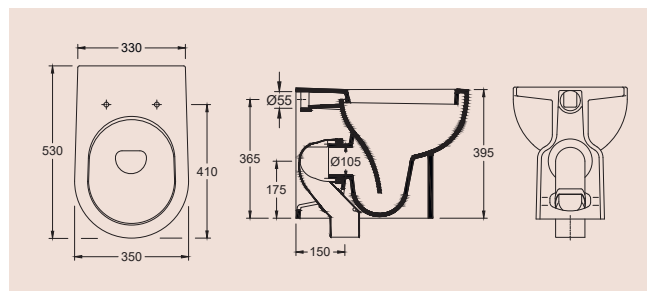

(35x53x40 cm)

37071002V

133 €

(35x53x40 cm)

37071002H

133 €

TAMPO TERMODUR SC CLIP-OFF

REF

BRANCO
BLANCO
WHITE

Tapa termodur SC clip-off
Toilet seat SC clip-off

50206000

78 €

TAMPO TERMODUR CLIP-OFF

Tapa termodur clip-off
Toilet seat clip-off

50207000

56 €



BIDÉ REF BRANCO BLANCO WHITE

Bidé
Bidet
(36x55x41 cm)

37411002K

88 €

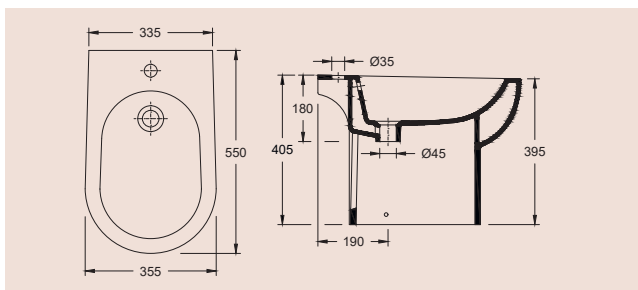

BIDÉ BTW REF BRANCO BLANCO WHITE

Bidé BTW
Bidet BTW
(36x53x41cm)

37441002K

128 €

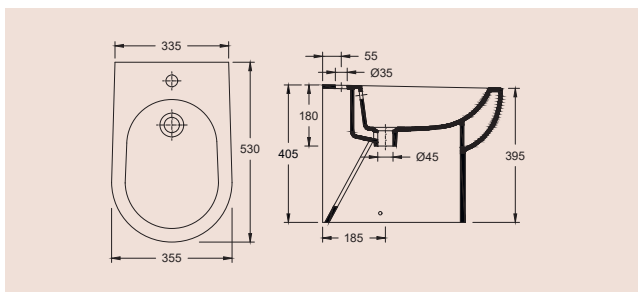

SANITA SUSPensa REF BRANCO BLANCO WHITE

Inodoro suspenso
Wall hung WC

(35x50x36 cm)

37001002K

132 €

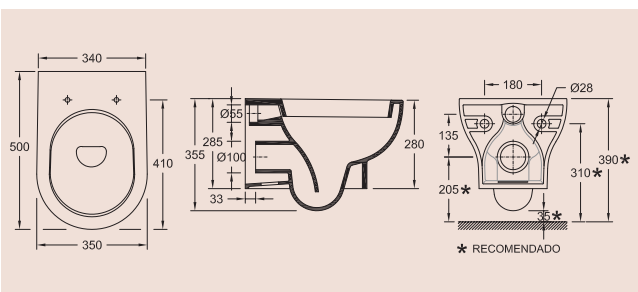

TAMPO TERMODUR SC CLIP-OFF REF BRANCO BLANCO WHITE

Tapa termodur SC clip-off
Toilet seat SC clip-off hinges

50208000

78 €

TAMPO TERMODUR CLIP-OFF

Tapa termodur clip-off
Toilet seat clip-off

50209000

56 €



BIDÉ SUSPENSO

REF

BRANCO
BLANCO
WHITE

Bidé suspenso
Wall hung bidet
(36x51x28 cm)

37401002K

88 €

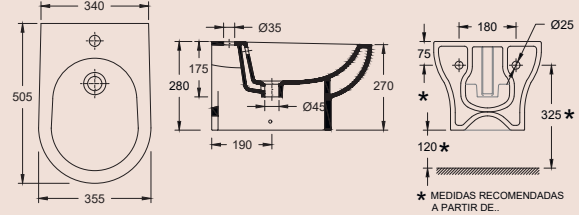

LAVATÓRIO MÉDIO

REF

BRANCO
BLANCO
WHITE

Lavabo médio
Washbasin medium

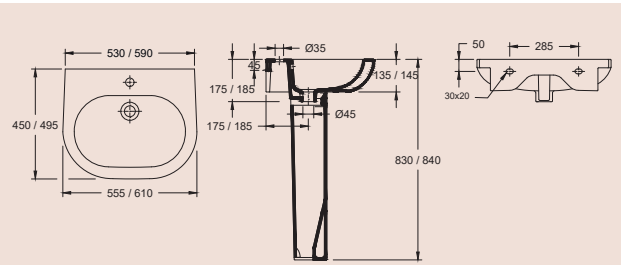

(61x50x19 cm)

37331002C

88 €

LAVATÓRIO JÚNIOR

Lavabo júnior
Washbasin júnior
(56x45x18 cm)

37311002C

78 €

COLUNA

Columna
Pedestal

37200002K

40 €

LAVATÓRIO MÉDIO

REF

BRANCO
BLANCO
WHITE

Lavabo médio
Washbasin medium

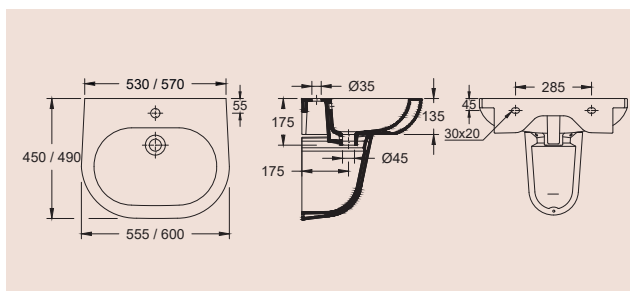

(60x49x18 cm)

37331002C

88 €

LAVATÓRIO JÚNIOR

Lavabo júnior
Washbasin júnior

37311002C

78 €

COLUNA SUSPensa

Columna suspendida
Wall hung pedestal

37220002K

70 €

**PACK OPUS DESCARGA VERTICAL,
MECANISMO ALIMENTAÇÃO INFERIOR,
TAMPO SC**

REF

BRANCO
BLANCO
WHITE

Pack Opus descarga vertical, mecanismo
alimentación inferior, tapa SC
Pack Opus vertical discharge,
bottom inlet mechanism, SC toilet seat

37904002K

305 €



Também disponíveis com descarga horizontal e alimentação lateral
También disponibles con descarga horizontal y alimentación lateral
Also available with horizontal discharge and side inlet mechanism

**PACK OPUS DESCARGA VERTICAL,
MECANISMO ALIMENTAÇÃO
INFERIOR, TAMPO**

REF

BRANCO
BLANCO
WHITE

Pack Opus descarga vertical, mecanismo
alimentación inferior, tapa
Pack Opus vertical discharged,
bottom inlet mechanism, toilet seat

37900002K

283 €



Também disponíveis com descarga horizontal e alimentação lateral
También disponibles con descarga horizontal y alimentación lateral
Also available with horizontal discharge and side inlet mechanism

KIT FIXAÇÃO P/LAVATÓRIO

REF

Kit de fijación p/ lavabo
Fixing kit for washbasin

55007001

6 €

KIT FIXAÇÃO LATERAL

REF

Kit de fijación lateral
Side fixing kit

55185000

7 €

KIT FIXAÇÃO P/ COLUNA SUSPENSA

REF

Kit de fijación p/ columna suspendida
Fixing kit for wall hung pedestal

55126010

22 €

CURVA DE DESCARGA VERTICAL (BTW)

REF

Curva de descarga vertical (BTW)
Vertical discharge curve (BTW)

55114011

21 €

TUBO DE DESCARGA HORIZONTAL 25CM

REF

Tubo de descarga horizontal 25cm
Horizontal discharge tube 25cm

55040010

21 €

MECANISMO DD ALIMENTAÇÃO INFERIOR

REF

Mecanismo DD alimentación inferior
Bottom inlet DD mechanism

55519010

29 €

MECANISMO DD DE ALIMENTAÇÃO LATERAL

REF

Mecanismo DD alimentación lateral
Side inlet DD mechanism

55517101

29 €

CURVA DE DESCARGA VERTICAL

REF

Curva de descarga vertical
Vertical discharge curve

55114030

21 €

SANITA COMPACTA V

REF

BRANCO
BLANCO
WHITE

Inodoro p/ tanque baixo V
Close coupled WC V

(37x69x40 cm)

13023002K

87 €

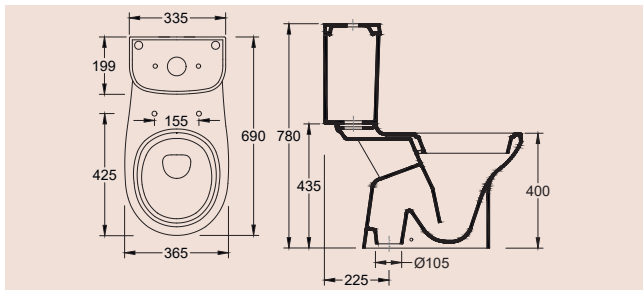

SANITA COMPACTA H

Inodoro p/ tanque baixo H
Close coupled WC H

(37x69x40 cm)

13021002K

87 €

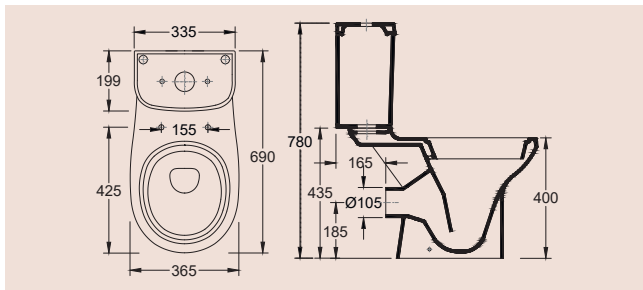

**TANQUE ALIMENTAÇÃO INFERIOR
C/ MECANISMO**

REF

BRANCO
BLANCO
WHITE

Tanque alimentación inferior con
mecanismo
Bottom inlet cistern with
mechanism

(34x20x34 cm)

13182002K

91 €

**TANQUE ALIMENTAÇÃO LATERAL
C/ MECANISMO**

Tanque alimentación lateral con
mecanismo
Side inlet cistern with mechanism

(34x20x34 cm)

13181002K

91 €



SANITA NORMAL V

REF

BRANCO
BLANCO
WHITE

Inodoro p/ tanque empotrado V
WC concealed V
(37x57x42 cm)

13013002K

87 €

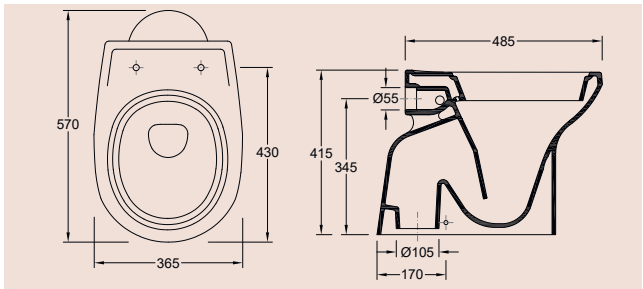

TAMPO TERMODUR

REF

BRANCO
BLANCO
WHITE

Tapa termodur
Toilet seat

50340000

47 €

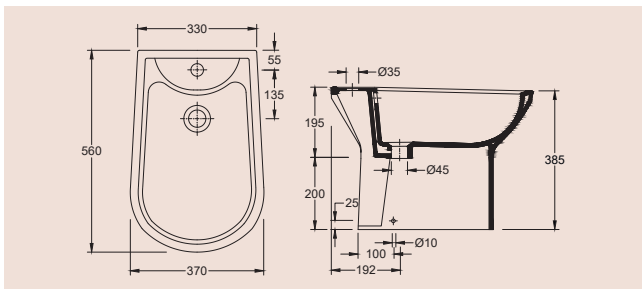

BIDÉ

REF

BRANCO
BLANCO
WHITE

Bidé
Bidet

(37x56x40 cm)

13411002K

82 €

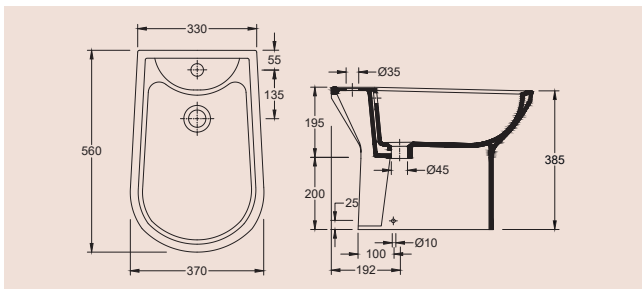

SANITA SUSPENSA

REF

BRANCO
BLANCO
WHITE

Inodoro suspenso
Wall hung WC

(37x53x37 cm)

13002002K

87 €

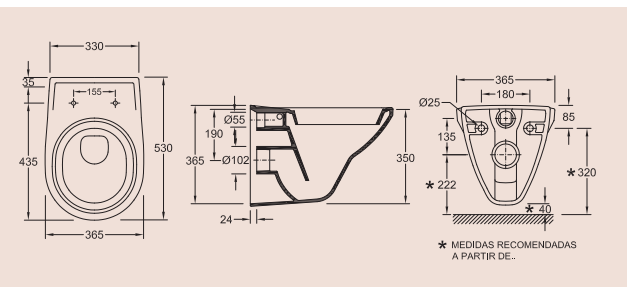



TAMPO TERMODUR

REF

BRANCO
BLANCO
WHITE

Tapa termodur
Toilet seat

50340000

47 €

BIDÉ SUSPENSO

REF

BRANCO
BLANCO
WHITE

Bidé suspenso
Wall hung bidet

(37x54x37 cm)

13401002K

77 €

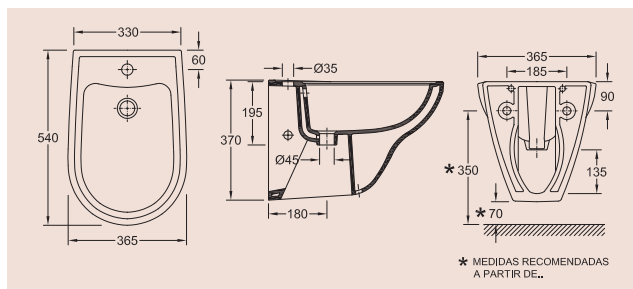

LAVATÓRIO NORMAL

REF

BRANCO
BLANCO
WHITE

Lavabo normal
Washbasin normal

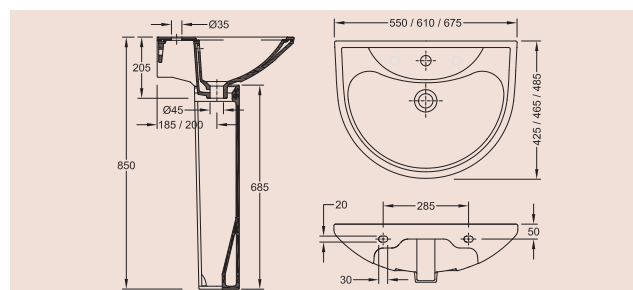

(68x49x21 cm)

13321002C

74 €

LAVATÓRIO MÉDIO

Lavabo médio
Wasbasin medium

(61x47x21 cm)

13331002C

65 €

LAVATÓRIO JÚNIOR

Lavabo júnior
Wasbasin júnior

(55x43x21 cm)

13311002C

54 €

COLUNA

Columna
Pedestal

37200002K

40 €



LAVATÓRIO NORMAL

REF

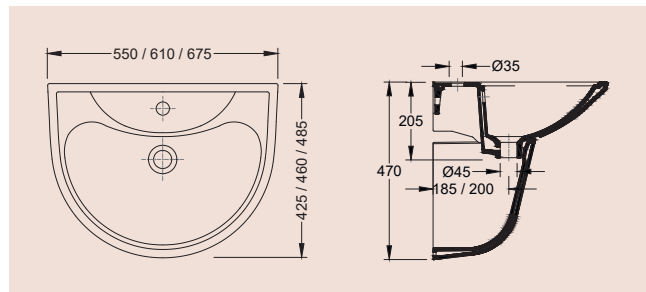
BRANCO
BLANCO
WHITELavabo normal
Washbasin normal

(68x49x21 cm)

13321002C

74 €

LAVATÓRIO MÉDIOLavabo médio
Wasbasin medium

(61x46x21 cm)

13331002C

65 €

LAVATÓRIO JÚNIORLavabo júnior
Wasbasin júnior

(55x43x21 cm)

13311002C

54 €

COLUNA SUSPENSAColumna suspendida
Wall hung pedestal

(22x27x32 cm)

37220002K

70 €

**PACK OCEANUS DESCARGA VERTICAL,
MECANISMO ALIMENTAÇÃO INFERIOR,
TAMPO**

REF

BRANCO
BLANCO
WHITEPack Oceanus descarga vertical,
mecanismo alimentación inferior, tapa
Pack Oceanus vertical discharge, bottom
inlet mechanism, toilet seat

13900002K

224 €

Também disponível com descarga horizontal e alimentação lateral
Tambien disponible con descarga horizontal e alimentación lateral
Also available with horizontal discharge and side inlet mechanism

KIT FIXAÇÃO P/ LAVATÓRIO

REF

Kit de fijación p/ lavabo
Fixing kit for washbasin

55007001

6 €



KIT FIXAÇÃO LATERAL

REF

Kit de fijación lateral
Side fixing kit

55185001

7 €



KIT FIXAÇÃO P/ COLUNA SUSPENSA

REF

Kit de fijación p/ columna suspendida
Fixing kit for wall hung pedestal

55126010

22 €



MECANISMO DD ALIMENTAÇÃO INFERIOR

REF

Mecanismo DD alimentación inferior
Bottom inlet DD mechanism

55517021

29 €



MECANISMO DD ALIMENTAÇÃO LATERAL

REF

Mecanismo DD alimentación lateral
Side inlet DD mechanism

55517041

29 €



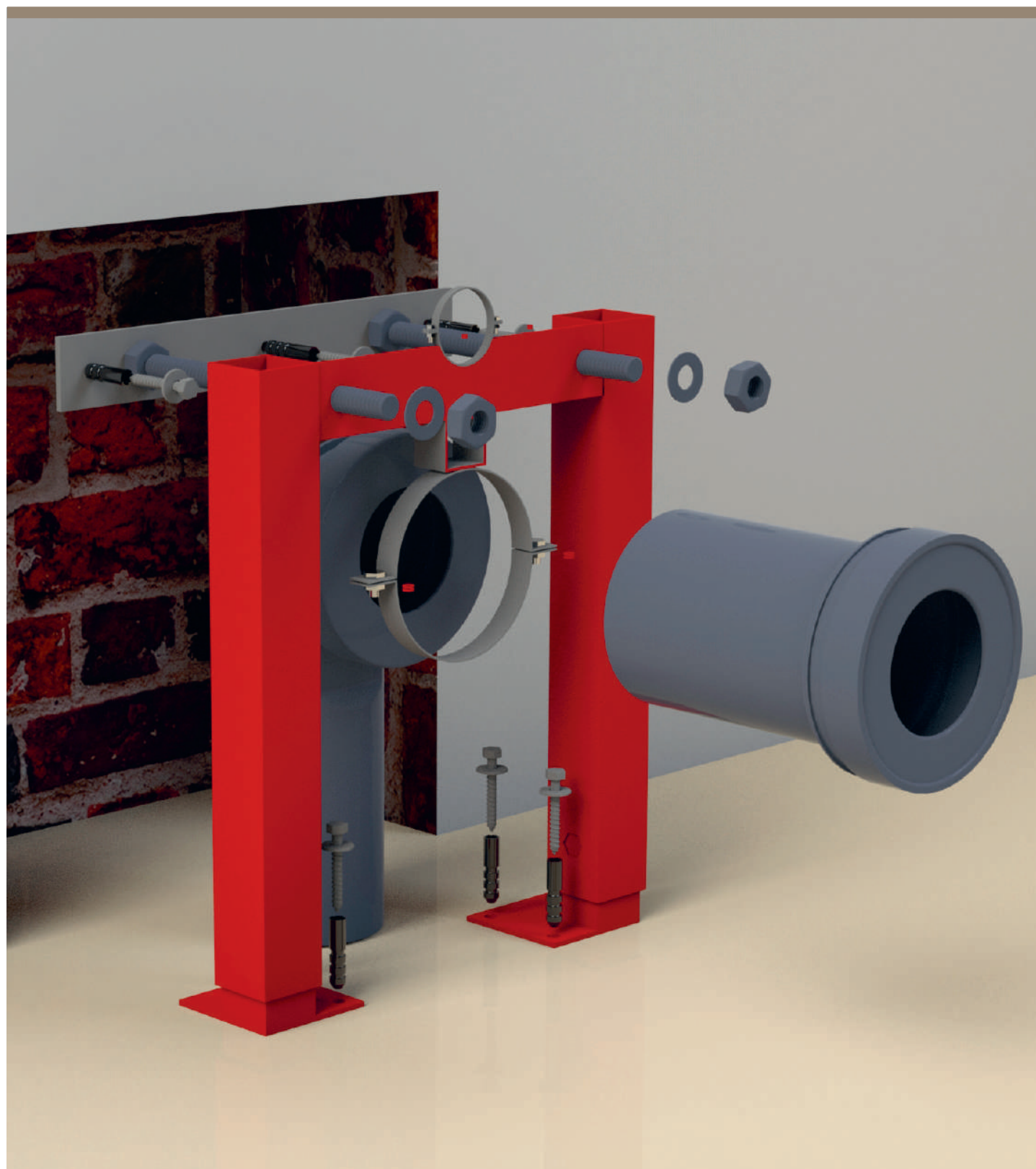

ESTRUTURAS

ESTRUCTURAS

STRUCTURES

ESTRUTURAS P/ SANITÁRIO SUSPENSO ESTRUCTURAS P/ SANITARIOS SUSPENDIDOS CONCEALED SYSTEMS FOR WALL HUNG WC	64
PLACAS DE COMANDO PANELES DE CONTROL COMMAND PANELS	66
ESTRUTURAS P/ INSTALAÇÃO DE URINÓIS ESTRUCTURAS PARA LA INSTALACIÓN DE URINARIOS URINALS INSTALLATION FRAMES	70



ESTRUTURA INTEGRAL (PLADUR E ALVENARIA; ESPESSURA 147MM)

REF

Estructura integral (manposteria y pladur; espesor 147mm)
Concealed full frame (masonry and plasterboard; depth 147mm)

55037074

173 €

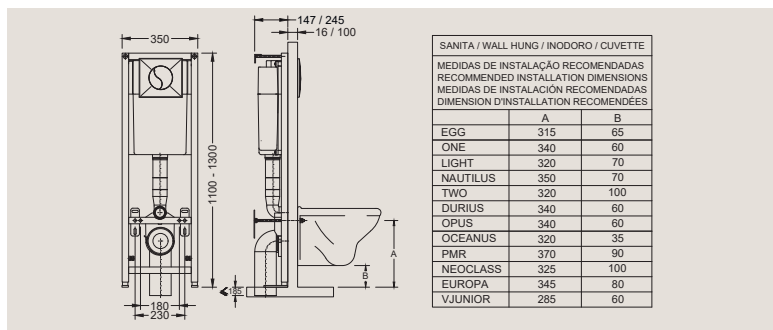

ESTRUTURA AUTOPORTANTE (PAREDES DE PLADUR; ESPESSURA 147MM)

REF

Estructura autoportante (paredes de pladur; espesor 147mm)
Self-supporting frame (plasterboard walls; depth 147mm)

55037076

225 €

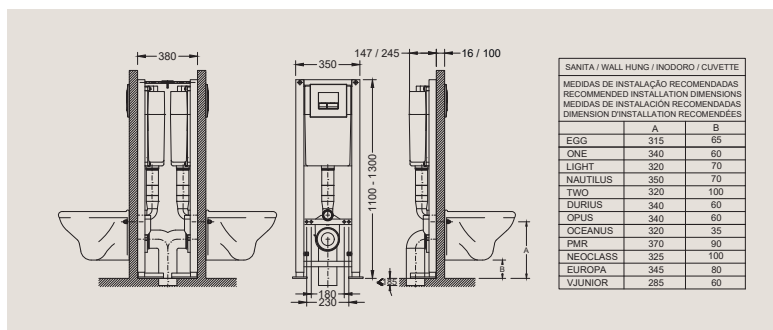

KIT DE CONVERSÃO DE 2 ESTRUTURAS 55037076 EM ESTRUTURA DUPLA

REF

Kit de conversión de 2 estructuras 55037076 en estructura doble
Conversion kit of 2 structures 55037076 in double structure

55037070

14 €

"T" DE EVACUAÇÃO PARA ESTRUTURA DUPLA DE SANITA

REF

"T" de evacuación para estructura doble de inodoro
Evacuation "T" for double toilet structure

55037071

15 €

ESTRUTURA INTEGRAL SLIM (PLADUR E ALVENARIA; ESPESSURA 93MM)

REF

Estructura integral Slim (manposteria y pladur; espesor 93mm)
Concealed full frame Slim (masonry and plasterboard; depth 93mm)

55037075

167 €

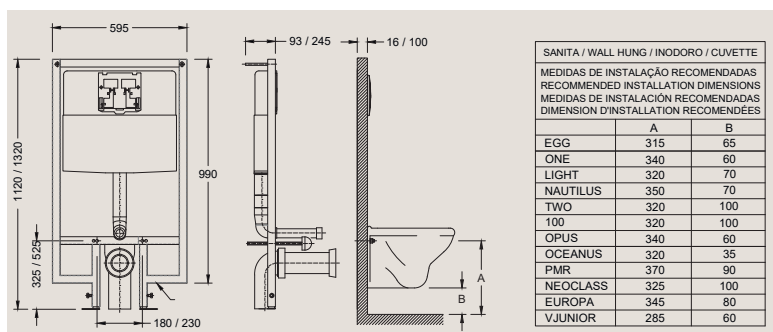

ESTRUTURA INTRASLIM (PAREDES DE ALVENARIA; ESPESSURA 93MM)

REF

Estructura Intraslim (paredes manposteria); espesor 93mm
Concealed half frame Intraslim (masonry walls); depth 93mm

55037094

119 €

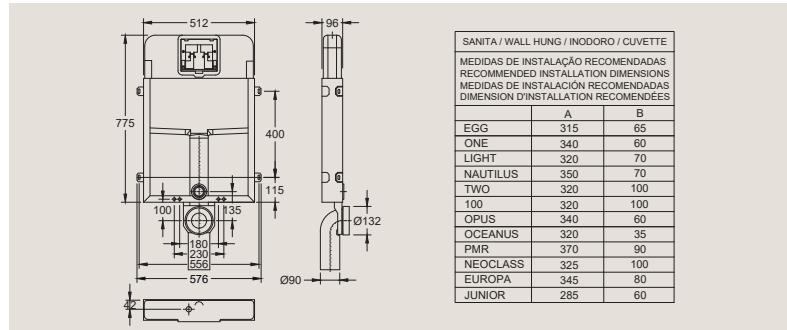

BARRAS DE REFORÇO P/ 55037094 (OPCIONAL)

Barras de refuerzo para 55037094 (opcional)
Reinforcement bars for 55037094 (optional)

55086021

55 €

TANQUE ENCASTRÁVEL DD INTRASLIM

REF

Tanque empotrado DD intraslim
Concealed cistern with DD mechanism intraslim

55037091

108 €

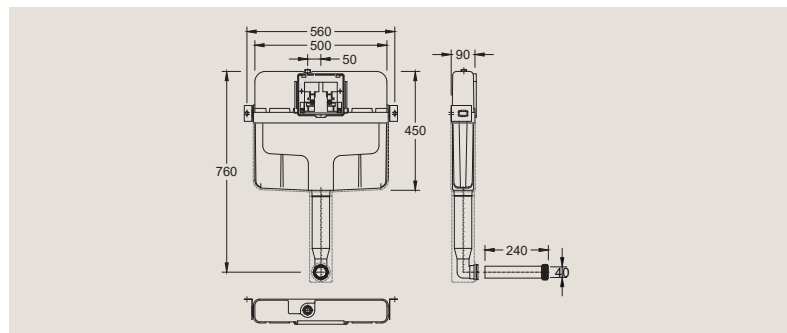
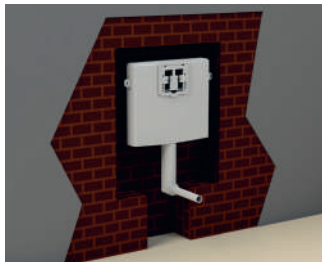

TILE C/ FRONTAL CERÂMICO E FRAME CROMADA

REF

BRANCO
BLANCO
WHITE

CORES STANDARD
COLORES STANDARD
STANDARD COLORS

Tile con frontal cerâmico e cuadro cromo
Tile with ceramic front panel and frame chrome

55038xx2

XX= 00 23 / 47 / 48

119 €

177€

TILE C/ FRONTAL CERÂMICO E FRAME BRANCA

Tile con frontal cerâmico e cuadro blanco
Tile with ceramic front panel and frame white

55038xx1

119 €

177 €

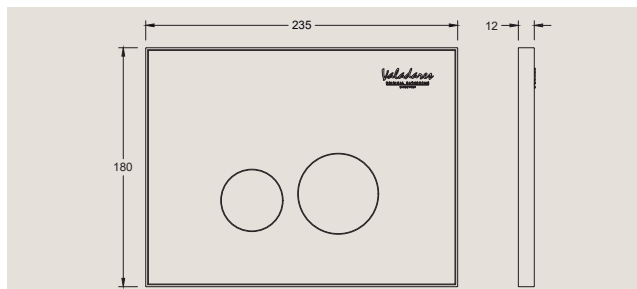
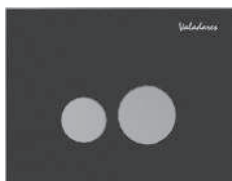

SQUARE CROMADO

REF

Square cromo
Square chrome plated

55034301

45 €

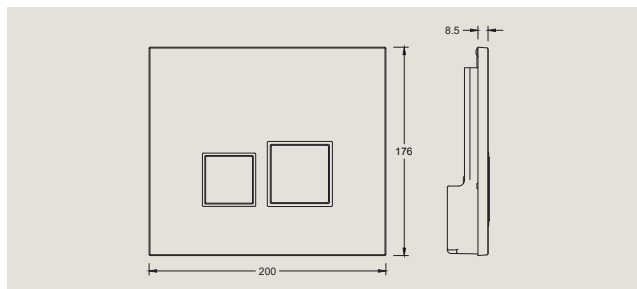

SQUARE BRANCO

Square blanco
Square white

55034303

45 €

SQUARE CROMADO MATE

Square cromo mate
Square matt chrome

55034304

45 €

SQUARE PRETO

Square negro
Square black

55034305

45 €

PLAT2 CROMADO REF

PLAT2 cromo
PLAT2 chrome plated

55034201

37 €

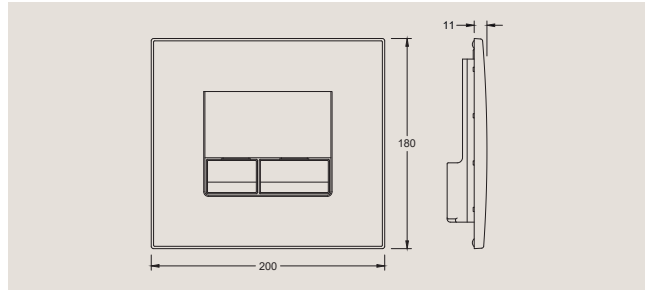

PLAT2 BRANCO

PLAT2 blanco
PLAT2 white

55034203

37 €

PLAT2 CROMO MATE

PLAT2 cromo mate
PLAT2 matt chrome

55034204

37 €

PLAT2 ANTIVANDALISMO CROMADO

PLAT2 antivandálico cromado
PLAT2 anti-vandalism chrome

55034211

75 €

GLOBE CROMADO REF

Globo cromo
Globe chrome plated

55034701

45 €

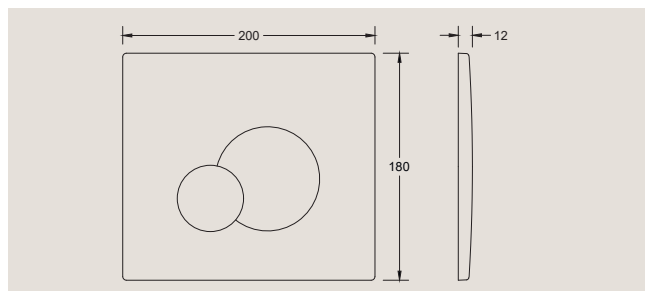

GLOBE BRANCO

Globe blanco
Globe white

55034703

45 €

GLOBE CROMADO MATE

Globe cromo mate
Globe matt chrome

55034704

45 €



ESTRUTURA INGENIO

REF

Estrutura Ingenio
Ingenio frame

55037080

296 €

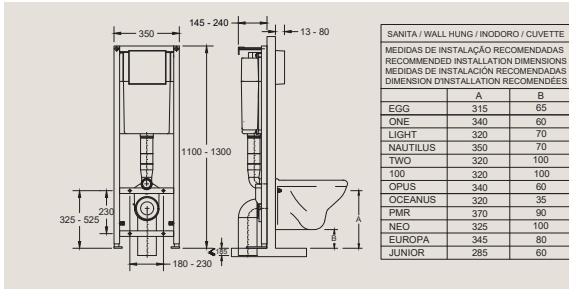

PLACA INGENIO CROMADO

REF

Panel ingenio cromo
Ingenio chrome plated panel

55034411

578 €

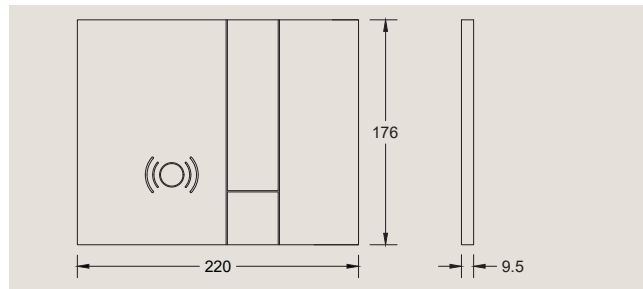
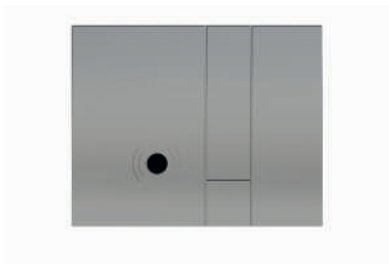

PLACA INGENIO BRANCO

Panel ingenio branco
Ingenio white panel

55034413

578 €

PLACA INGENIO PRETO

Panel ingenio negro
Ingenio black panel

55034415

578 €

ESTRUTURA P/ SANITA SEM TANQUE

REF

Estructura para inodoro suspenso sin tanque
WC wall mount half frame without flushing cistern

55036201

140 €

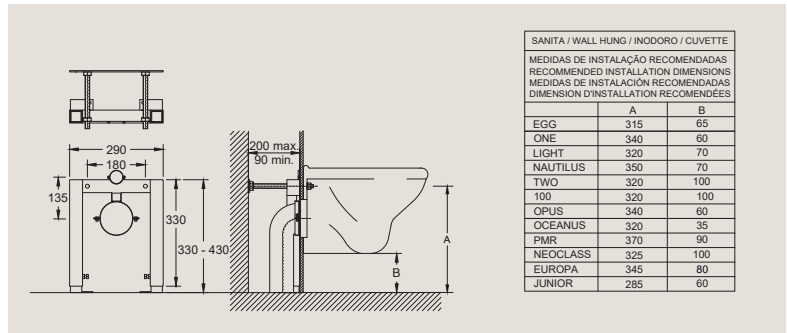
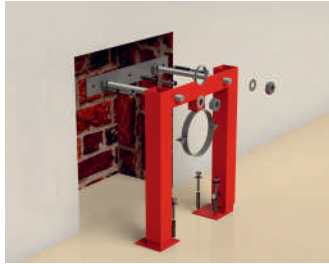

ESTRUTURA P/ BIDÉS SUSPENSOS HIDE

REF

Estructura para bidés suspendidos hide
Frame for wall hung hide bidets

55046001

99 €

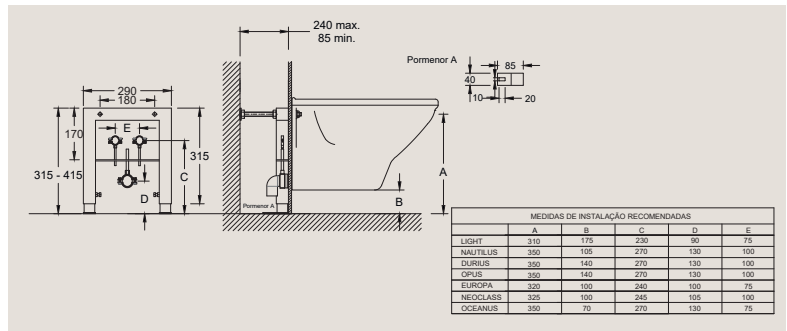

ESTRUTURA P/ BIDÉS SUSPENSOS C/ FIXAÇÃO VISÍVEL

REF

Estructura para bidés suspendidos con fijación visible
Frame for wall hung bidets with visible fixation

55046001K

105 €

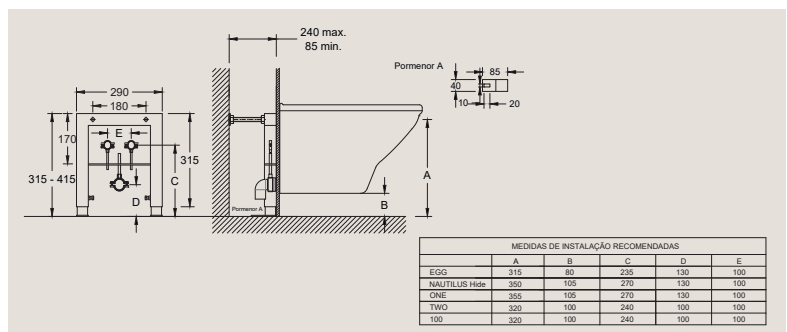

ESTRUTURA P/ LAVATÓRIO SUSPENSO

REF

Estructura para lavabo suspenso
Washbasin wall mount frame

55035001

155 €

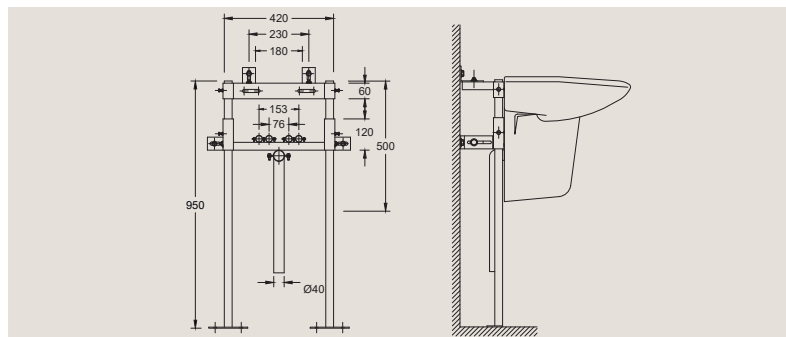
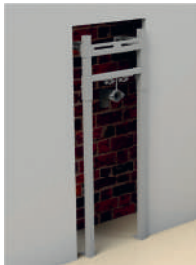

ESTRUTURA PARA URINOIS EGG/ KINO

REF

Estructura para urinarios EGG/KINO
Urinals wall mount frame EGG/KINO

55036010

403 €

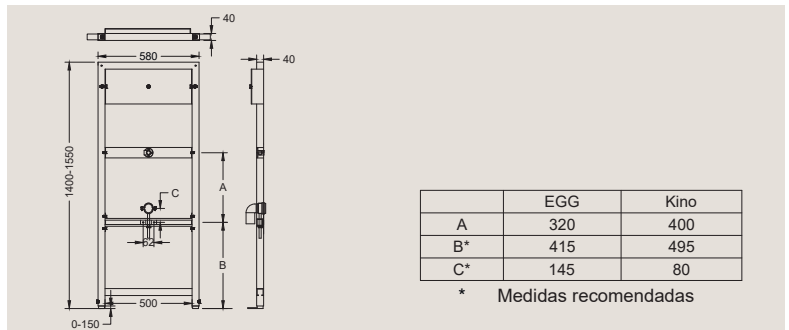

ESTRUTURA PARA URINOIS ORBITAL/ FLORIDA

REF

Estructura para urinarios ORBITAL/FLORIDA
Urinals wall mount frame ORBITAL/FLORIDA

55036011

403 €

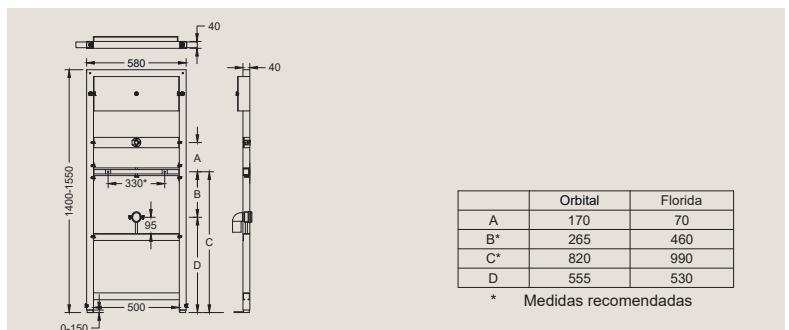

**ESTRUTURA PARA URINOL
FACE**

REF

Estructura para urinario FACE
Urinal wall mount frame FACE

55036012

403 €

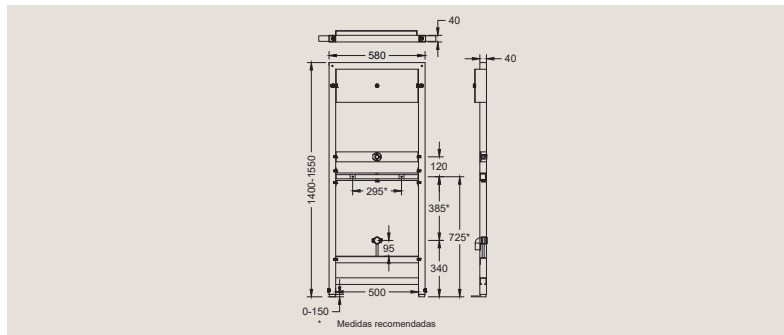
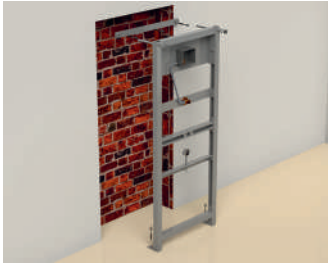





LAVATÓRIOS

LAVABOS

WASHBASINS



ESPECIAIS 78
ESPECIALES
SPECIALS

SUSPENSOS 84
SUSPENDIDOS
WALL HUNG

LAVA MÃOS 86
LAVA MANOS
HAND WASHBASINS

POUSAR 88
SOBRE MUEBLE
STANDING

EMBUTIR 95
SOBRE ENCIMERA
EMBEDDED

SEMI EMBUTIR 96
SEMI INTEGRAR
SEMI EMBEDDED

ENCASTRAR 97
BAJO ENCIMERA
RECESSED



ESPECIAIS | ESPECIALES | SPECIALS



PLATINIUM
PAG 78



APOLO
PAG 80



EGG
PAG 82



KOBE
PAG 82



PORTO
PAG 79



RAFAEL
PAG 79

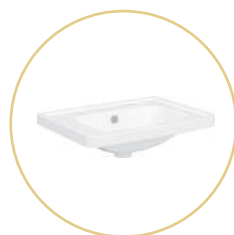

NEO
PAG 82



RUBENS
PAG 83



SERRAS
PAG 81



NEO
PAG 80

SUSPENSOS | SUSPENDIDOS | WALL HUNG



AVIZ
PAG 84



GALLERY
PAG 85



ONE LINE
PAG 85



RECIFE PLUS
PAG 85



EGG
PAG 84

LAVA MÃOS | LAVA MANOS | HAND WASHBASINS



CEUTA
PAG 87



EROS
PAG 86



ISIS
PAG 86



LAVA MÃOS
LAVA MANOS
HAND WASHBASIN
PAG 87



VÊNUS
PAG 86



LAVA MÃOS DE CANTO
LAVA MANOS DE RINCON
CORNER HAND WASHBASIN
PAG 87

POUSAR | SOBRE MUEBLE | STANDING



AVIZ
PAG 88



BARI
PAG 88



BOSTON
PAG 93



CHAGALL
PAG 89



DARK
PAG 94



EGG
PAG 91



ISIS
PAG 89



MACAU
PAG 90



MALIBU
PAG 92



RENOIR
PAG 89



100
PAG 90



POUSAR | SOBRE MUEBLE | STANDING



MIAMI
PAG 94



ONE SLIM
PAG 92



PICASSO
PAG 90



RECIFE PLUS
PAG 91



SAVOY
PAG 91



TAITI
PAG 92



TICIANO
PAG 94



URANO
PAG 93



VAN GOGH
PAG 88



ZEN
PAG 93

EMBUTIR | SOBRE ENCIMERA | EMBEDDED



GOA
PAG 95



MIRAMAR
PAG 95



OÁSIS
PAG 95



PALM
PAG 95

SEMI EMBUTIR | SEMI INTEGRAR | SEMI EMBEDDED



BARI
PAG 96



ROMA
PAG 96



TORINO
PAG 96

ENCASTRAR | BAJO ENCIMERA | RECESSED



DALI
PAG 97



MISSOURI
PAG 97



NICE
PAG 97



OVAL
PAG 97



TÂNGER
PAG 98

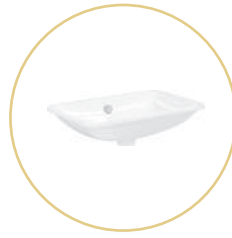

TÂNGER S
PAG 98



TOLEDO
PAG 98



PLATINIUM

REF

BRANCO
BLANCO
WHITE

CORES STANDARD
COLORES STANDARD
STANDARD COLORS

CORES ESPECIAIS
COLORES ESPECIALES
SPECIAL COLORS

XX=

00

23 / 47 / 48

PÁG. 8

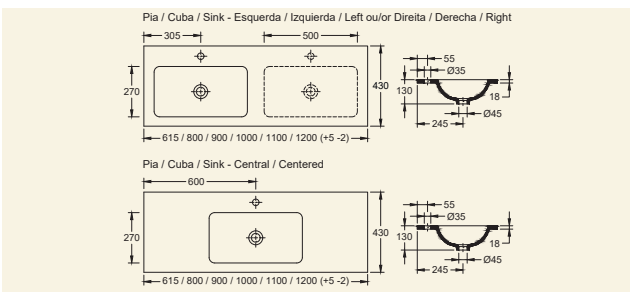

120 (120x43x13 cm)	79362xx2C	423 €	740 €	846 €
110 (110x43x13 cm)	79352xx2C	394 €	690 €	788 €
100 (100x43x13 cm)	79342xx2C	350 €	613 €	700 €
90 (90x43x13 cm)	79332xx2C	264 €	462 €	528 €
80 (80x43x13 cm)	79322xx2C	250 €	438 €	500 €

DIM.	120			110			100			90			80		
	E/I/L	D/R	C	E/I/L	D/R	C	E/I/L	D/R	C	E/I/L	D/R	C	E/I/L	D/R	C
79362XX2	X														
79363XX2		X													
79361XX2			X												
79352XX2				X											
79353XX2					X										
79351XX2						X									
79342XX2							X								
79343XX2								X							
79341XX2									X						
79332XX2										X					
79333XX2											X				
79331XX2												X			
79322XX2													X		
79323XX2														X	
79321XX2															X

E/I/L = Esquerdo / Izquierdo / Left
D/R = Direito / Derecho / Right
C = Central / Central / Centered

PLATINIUM 60 C/ PIO AO CENTRO

REF

BRANCO
BLANCO
WHITE

CORES STANDARD
COLORES STANDARD
STANDARD COLORS

CORES ESPECIAIS
COLORES ESPECIALES
SPECIAL COLORS

XX=

00

23 / 47 / 48

PÁG. 8

Platinum 60 cuba al centro
Platinum 60 centered sink

(60x43x13 cm)

79301xx2C

219 €

383 €

438 €

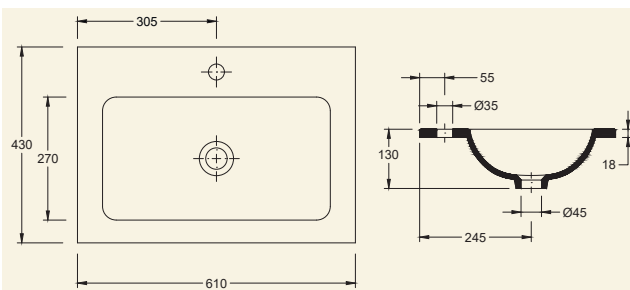

PORTO (C/ FURO TORNEIRA)

REF

BRANCO
BLANCO
WHITECORES STANDARD
COLORES STANDARD
STANDARD COLORSCORES ESPECIAIS
COLORES ESPECIALES
SPECIAL COLORSPorto (c/ agujero p/ grifo)
Porto (w/ tap hole)

(80x44x10 cm)

79621xx2C

XX=

00

23 / 47 / 48

PÁG. 8

299 €

523 €

598 €

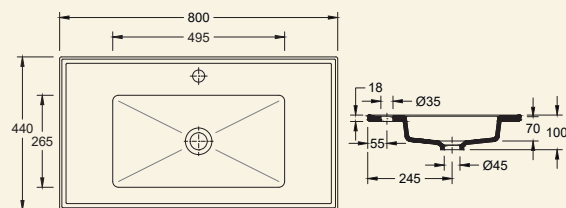

RAFAEL DUPLA PIA

REF

BRANCO
BLANCO
WHITECORES STANDARD
COLORES STANDARD
STANDARD COLORSCORES ESPECIAIS
COLORES ESPECIALES
SPECIAL COLORSRafael c/ dos cubas
Rafael w/ double sink

(120x46x12 cm)

79842xx2C

XX=

00

23 / 47 / 48

PÁG. 8

539 €

943 €

1.078 €

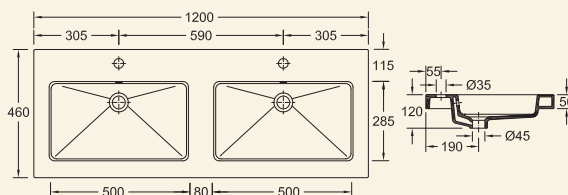

RAFAEL

REF

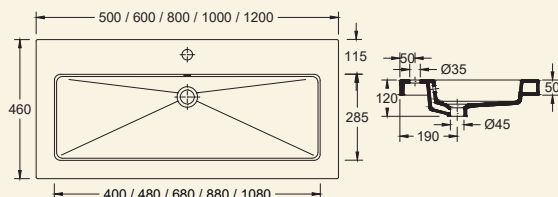
BRANCO
BLANCO
WHITECORES STANDARD
COLORES STANDARD
STANDARD COLORSCORES ESPECIAIS
COLORES ESPECIALES
SPECIAL COLORS

120 (120x46x12 cm)	79831xx2C	539 €	943 €	1.076 €
100 (100x46x12 cm)	79821xx2C	312 €	546 €	624 €
80 (80x46x12 cm)	79811xx2C	233 €	408 €	466 €
60 (60x46x12 cm)	79801xx2C	200 €	350 €	400 €
50 (50x46x12 cm)	79861xx2C	200 €	350 €	400 €

RAFAEL PIO CENTRAL 50CM

REF

BRANCO
BLANCO
WHITE

CORES STANDARD
COLORES STANDARD
STANDARD COLORS

CORES ESPECIAIS
COLORES ESPECIALES
SPECIAL COLORS

Rafael con cuba al centro 50cm
Rafael with centered sink 50cm

XX=

00

23 / 47 / 48

PÁG. 8

(100x46x12 cm)

79851xx2C

438 €

767 €

876 €

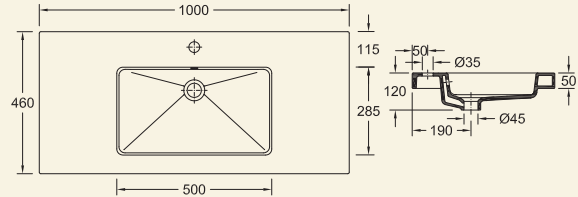

APOLO

REF

BRANCO
BLANCO
WHITE

CORES STANDARD
COLORES STANDARD
STANDARD COLORS

CORES ESPECIAIS
COLORES ESPECIALES
SPECIAL COLORS

XX=

00

23 / 47 / 48

PÁG. 8

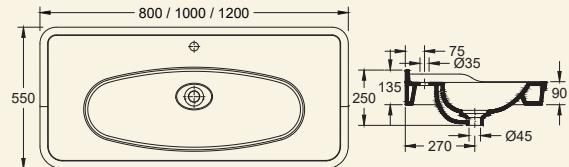

120 (120x55x25 cm)

78331xx2C

1.164 €

2.038 €

2.328 €

100 (100x55x25 cm)

78321xx2C

795 €

1.392 €

1.590 €

80 (80x55x25 cm)

78311xx2C

494 €

864 €

988 €

VÁLVULA VCC C/ TAMPA CERÂMICA APOLO

REF

BRANCO
BLANCO
WHITE

CORES STANDARD
COLORES STANDARD
STANDARD COLORS

CORES ESPECIAIS
COLORES ESPECIALES
SPECIAL COLORS

Válvula VCC con tapa cerâmica Apolo
VCC waste with ceramic cover Apolo

XX=

00

23 / 47 / 48

PÁG. 8

55115002xx

92 €

125 €

157 €

NEOCLÁSSICO DE EMBUTIR REDONDO

REF

BRANCO
BLANCO
WHITE

CORES STANDARD
COLORES STANDARD
STANDARD COLORS

CORES ESPECIAIS
COLORES ESPECIALES
SPECIAL COLORS

Neoclássico sobre encimera redondo
Embedded Neoclássico round

XX=

00

23 / 47 / 48

PÁG. 8

(Ø 45 cm)

16387xx2C

377 €

660 €

754 €

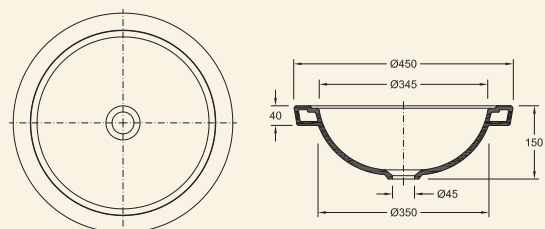

SERRAS		REF	BRANCO BLANCO WHITE	CORES STANDARD COLORES STANDARD STANDARD COLORS	CORES ESPECIAIS COLORES ESPECIALES SPECIAL COLORS
(Ø 40 cm)	78840xx2C		XX= 00	23 / 47 / 48	PÁG. 8
			260 €	455 €	519 €
					
SABONETEIRA SERRAS		REF	BRANCO BLANCO WHITE	CORES STANDARD COLORES STANDARD STANDARD COLORS	CORES ESPECIAIS COLORES ESPECIALES SPECIAL COLORS
Jabonera Serras Soap tray Serras	21400xx2		XX= 00	23 / 47 / 48	PÁG. 8
			33 €	59 €	66 €
					
COPO SERRAS		REF	BRANCO BLANCO WHITE	CORES STANDARD COLORES STANDARD STANDARD COLORS	CORES ESPECIAIS COLORES ESPECIALES SPECIAL COLORS
Vaso Serras Cup Serras	21600xx2		XX= 00	23 / 47 / 48	PÁG. 8
			40 €	71 €	80 €
					
PRATELEIRA SERRAS		REF	BRANCO BLANCO WHITE	CORES STANDARD COLORES STANDARD STANDARD COLORS	CORES ESPECIAIS COLORES ESPECIALES SPECIAL COLORS
Estante Serras Shelf Serras	21500xx2		XX= 00	23 / 47 / 48	PÁG. 8
			74 €	129 €	147 €
					

NEOCLÁSSICO RETANGULAR DE EMBUTIR

REF

BRANCO
BLANCO
WHITE

CORES STANDARD
COLORES STANDARD
STANDARD COLORS

CORES ESPECIAIS
COLORES ESPECIALES
SPECIAL COLORS

Neoclássico sobre encimera retangular
Neoclássico embedded rectangular
(60x47x4 cm)

16381xx2C

XX=

00

23 / 47 / 48

PÁG. 8

377 €

660 €

755 €

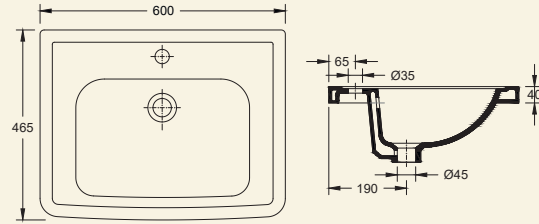

EGG COLUNA INTEGRADA

REF

BRANCO
BLANCO
WHITE

CORES STANDARD
COLORES STANDARD
STANDARD COLORS

CORES ESPECIAIS
COLORES ESPECIALES
SPECIAL COLORS

EGG columna
EGG with integrated pedestal
(48x52x90 cm)

39881xx2C

XX=

00

23 / 47 / 48

PÁG. 8

1.184 €

2.073 €

2.369 €

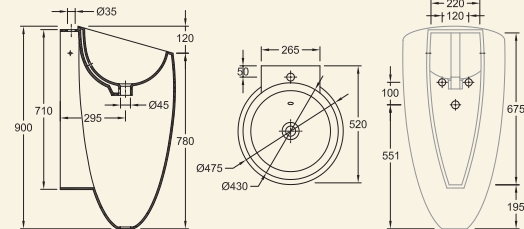

Complementos incluídos | Complementos incluidos | Included complements 55185000

KOBE (COM SAÍDA INFERIOR)

REF

BRANCO
BLANCO
WHITE

CORES STANDARD
COLORES STANDARD
STANDARD COLORS

CORES ESPECIAIS
COLORES ESPECIALES
SPECIAL COLORS

Kobe (con salida inferior)
Kobe (with bottom outlet)
(Ø 45x82 cm)

79910xx2C

XX=

00

23 / 47 / 48

PÁG. 8

988 €

1.729 €

1.976 €

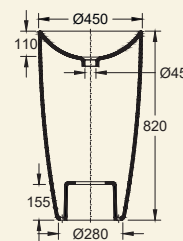

Complementos incluídos | Complementos incluidos | Included complements 55023052, 55110042

KOBE (COM SAÍDA LATERAL)**REF**BRANCO
BLANCO
WHITECORES STANDARD
COLORES STANDARD
STANDARD COLORSCORES ESPECIAIS
COLORES ESPECIALES
SPECIAL COLORSKobe (con salida lateral)
Kobe (with side outlet)
(Ø 45x82 cm)

79911xx2C

XX=

00

23 / 47 / 48

PÁG. 8

988 €

1.729 €

1.976 €

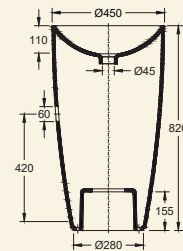

Complementos incluídos | Complementos incluidos | Included complements 55079000, 55110042

RUBENS**REF**BRANCO
BLANCO
WHITECORES STANDARD
COLORES STANDARD
STANDARD COLORSCORES ESPECIAIS
COLORES ESPECIALES
SPECIAL COLORS

(Ø 40x44 cm)

79900xx2C

XX=

00

23 / 47 / 48

PÁG. 8

452 €

791 €

903 €

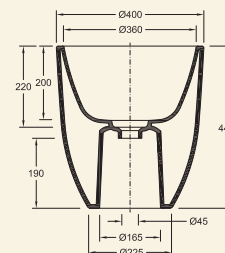

Complementos incluídos | Complementos incluidos | Included complements 55110030, 20950002

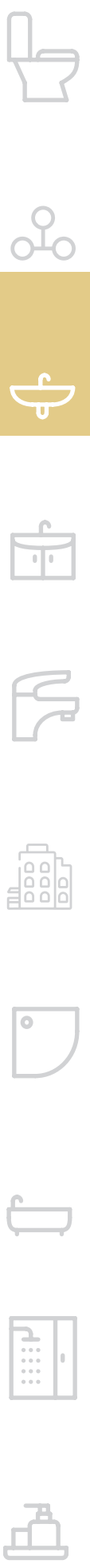

AVIZ	REF	BRANCO BLANCO WHITE	PRETO NEGRO BLACK
------	-----	---------------------------	-------------------------

XX= 00 48

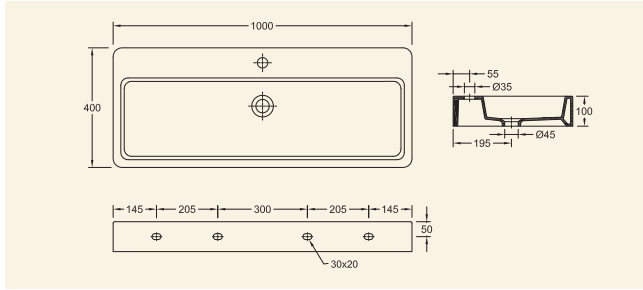

100 (100x40x10 cm)	79741xx2C	283 €	496 €
--------------------	-----------	-------	-------

Complementos incluídos | Complementos incluídos | Included complements 55007001

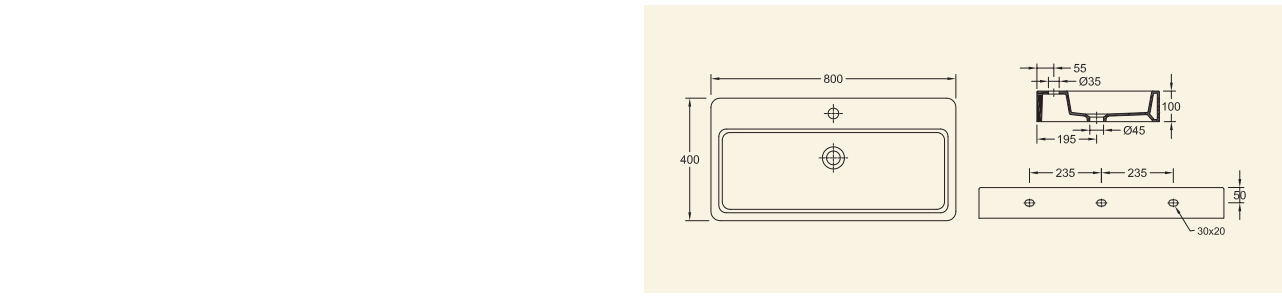

80 (80x40x10 cm)	79721xx2C	213 €	374 €
------------------	-----------	-------	-------

Complementos incluídos | Complementos incluídos | Included complements 55007320

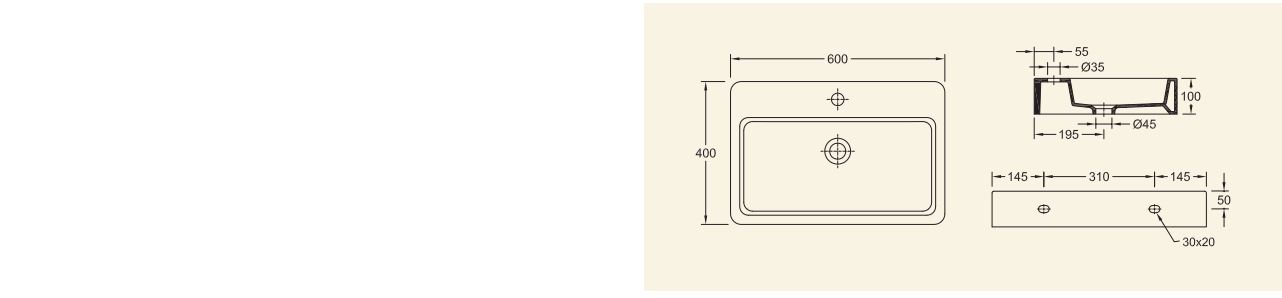

60 (60x40x10 cm)	79701xx2C	167 €	291 €
------------------	-----------	-------	-------

Complementos incluídos | Complementos incluídos | Included complements 55007001

LAVATÓRIO SUSPENSO COLUNA INTEGRADA	REF	BRANCO BLANCO WHITE	CORES STANDARD COLORES STANDARD STANDARD COLORS	CORES ESPECIAIS COLORES ESPECIALES SPECIAL COLORS
-------------------------------------	-----	---------------------------	---	---

XX= 00 23 / 47 / 48 PÁG. 8

Lavabo columna suspenso
Wall hung washbasin with integrated
pedestal

(35x34x59 cm)	39871xx2K	331 €	578 €	659 €
---------------	-----------	-------	-------	-------

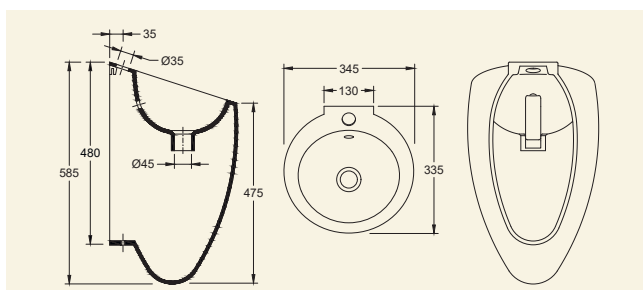

ONE LINE **REF** **BRANCO BLANCO WHITE** **CORES STANDARD COLORES STANDARD STANDARD COLORS** **CORES ESPECIAIS COLORES ESPECIALES SPECIAL COLORS**

XX= 00 23 / 47 / 48 PÁG. 8

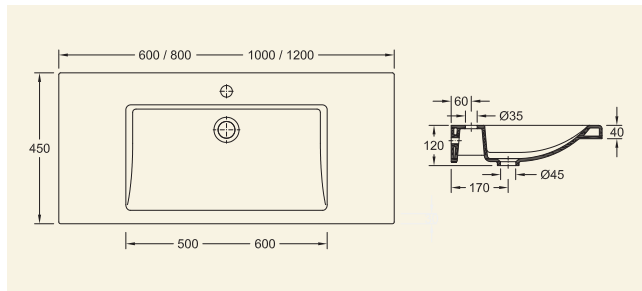

Size (cm)	REF	BRANCO BLANCO WHITE	CORES STANDARD COLORES STANDARD STANDARD COLORS	CORES ESPECIAIS COLORES ESPECIALES SPECIAL COLORS
120 (120x45x12 cm)	40331xx2C	423 €	740 €	845 €
100 (100x45x12 cm)	40321xx2C	335 €	587 €	670 €
90 (90x45x12 cm)	40361xx2C	297 €	520 €	594 €
80 (80x45x12 cm)	40311xx2C	264 €	462 €	528 €
70 (70x45x12 cm)	40341xx2C	234 €	410 €	468 €
60 (60x45x12 cm)	40301xx2C	206 €	359 €	411 €

Complementos incluídos | Complementos incluidos | Included complements 120 - 55007001 ; 100 - 55007001 ; 80 - 55007320 ; 60 - 55007001

GALLERY **REF** **BRANCO BLANCO WHITE**

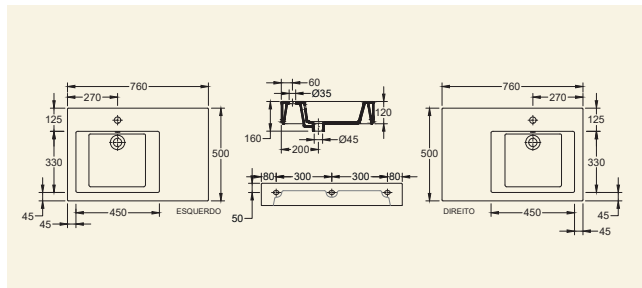

Direito
Derecho
Right

(76x50x12 cm) 78821002C 408 €

Complementos incluídos | Complementos incluidos | Included complements 55007320

Esquerdo
Izquierdo
Left

(76x50x12 cm) 78831002C 408 €

Complementos incluídos | Complementos incluidos | Included complements 55007320

RECIFE PLUS **REF** **BRANCO BLANCO WHITE** **PRETO NEGRO BLACK**

XX= 00 48

(45x45x10 cm) 78761xx2C 91 € 160 €

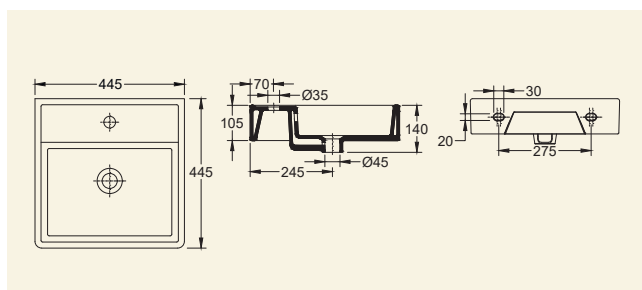

Complementos incluídos | Complementos incluidos | Included complements 55007001
Outras opções sob consulta | otras opciones bajo consulta | Other options on request

ISIS

REF

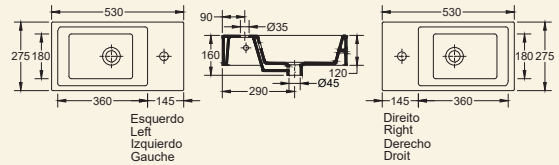
BRANCO
BLANCO
WHITEEsquerdo
Izquierdo
Left

(53x28x12 cm)

78812002C

137 €

Complementos incluídos | Complementos incluidos | Included complements 55007001

Direito
Derecho
Right

(53x28x12 cm)

78813002C

137 €

Complementos incluídos | Complementos incluidos | Included complements 55007001

EROS

REF

BRANCO
BLANCO
WHITE

(32x32x11 cm)

18851002C

87 €

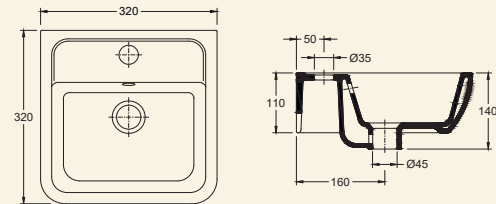

Complementos incluídos | Complementos incluidos | Included complements 55007001

VÉNUS

REF

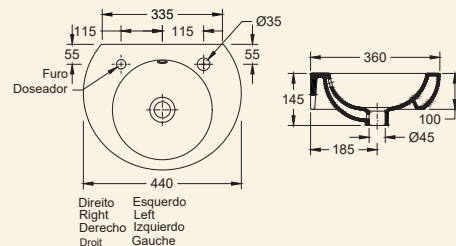
BRANCO
BLANCO
WHITETorneira esquerda
Grifo izquierdo
Left tap hole

(44x36x10 cm)

18862002C

115 €

Complementos incluídos | Complementos incluidos | Included complements 55007001

Torneira direita
Grifo derecho
Right tap hole

(44x36x10 cm)

18863002C

115 €

Complementos incluídos | Complementos incluidos | Included complements 55007001

Outras opções sob consulta | otras opciones bajo consulta | Other options on request

CEUTA**REF**BRANCO
BLANCO
WHITE

(43x43x10 cm)

18801002C

115 €

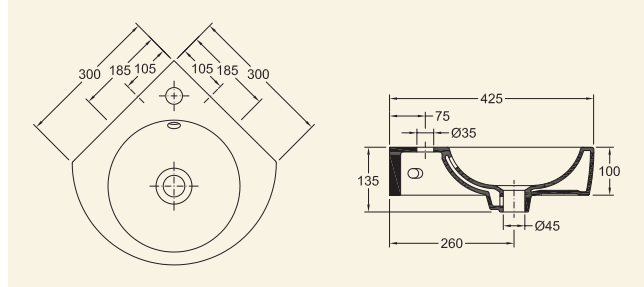

Complementos incluídos | Complementos incluidos | Included complements 55007001

LAVA MÃOS DE CANTO**REF**BRANCO
BLANCO
WHITELava manos de rincon
Corner hand washbasin

(45x39x10 cm)

18307002C

102 €

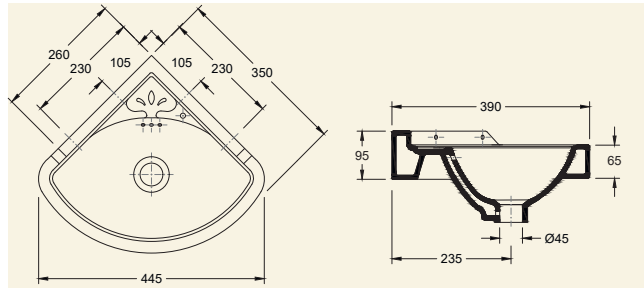

Complementos incluídos | Complementos incluidos | Included complements 55007003

LAVA MÃOS**REF**BRANCO
BLANCO
WHITELava manos
Hand washbasin

(45x35x17 cm)

12361002C

44 €

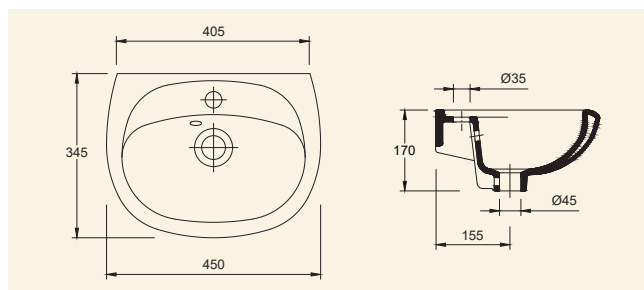

Complementos incluídos | Complementos incluidos | Included complements 55007001

AVIZ V4

REF

BRANCO
BLANCO
WHITE

CORES STANDARD
COLORES STANDARD
STANDARD COLORS

CORES ESPECIAIS
COLORES ESPECIALES
SPECIAL COLORS

XX=

00

23 / 47 / 48

PÁG. 8

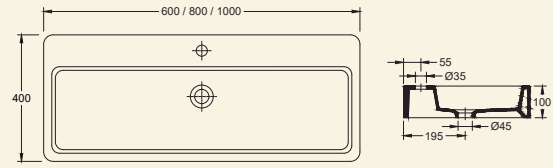

100 (100x40x10 cm)	79744xx2C	275 €	482 €	549 €
80 (80x40x10 cm)	79724xx2C	206 €	361 €	412 €
60 (60x40x10 cm)	79704xx2C	161 €	281 €	322 €

BARI

REF

BRANCO
BLANCO
WHITE

CORES STANDARD
COLORES STANDARD
STANDARD COLORS

CORES ESPECIAIS
COLORES ESPECIALES
SPECIAL COLORS

XX=

00

23 / 47 / 48

PÁG. 8

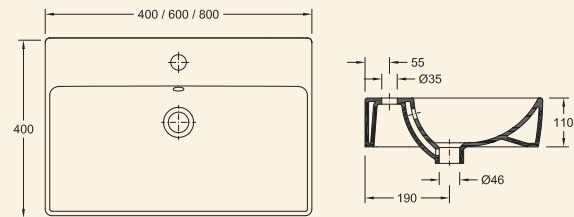

80 (80x40x11 cm)	79441xx2C	241 €	421 €	482 €
60 (60x40x11 cm)	79431xx2C	173 €	302 €	346 €
50 (50x40x11 cm)	79421xx2C	152 €	266 €	304 €
40 (40x40x11 cm)	79411xx2C	131 €	230 €	263 €

VAN GOGH

REF

BRANCO
BLANCO
WHITE

CORES STANDARD
COLORES STANDARD
STANDARD COLORS

CORES ESPECIAIS
COLORES ESPECIALES
SPECIAL COLORS

XX=

00

23 / 47 / 48

PÁG. 8

(60x41x10 cm)

78867xx2C

198 €

348 €

396 €

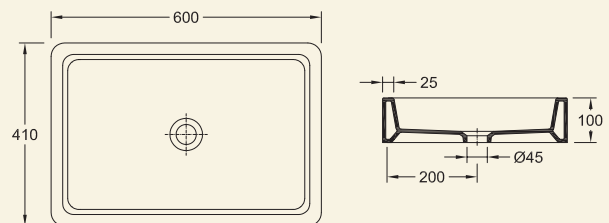

CHAGALL**REF**BRANCO
BLANCO
WHITECORES STANDARD
COLORES STANDARD
STANDARD COLORSCORES ESPECIAIS
COLORES ESPECIALES
SPECIAL COLORS

XX=

00

23 / 47 / 48

PÁG. 8

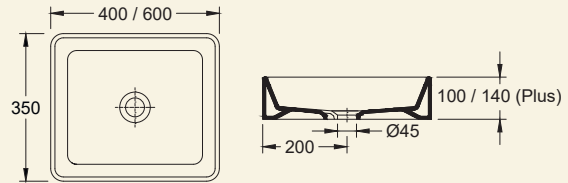

Model	REF	BRANCO BLANCO WHITE	CORES STANDARD COLORES STANDARD STANDARD COLORS	CORES ESPECIAIS COLORES ESPECIALES SPECIAL COLORS
60 Plus (60x35x14 cm)	78865xx2C	286 €	502 €	572 €
60 (60x35x10 cm)	78860xx2C	212 €	371 €	423 €
40 (40x35x10 cm)	78850xx2C	178 €	311 €	355 €

ÍISIS DE POUSAR**REF**BRANCO
BLANCO
WHITEÍisis sobre mueble
Íisis standing

(53x28x12 cm)

78811002C

137 €

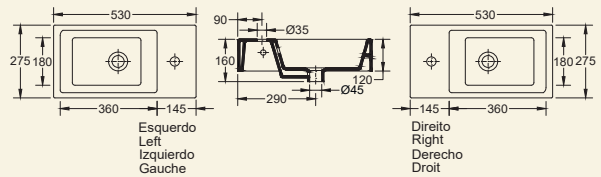

Complementos incluídos | Complementos incluidos | Included complements 55007001

RENOIR**REF**BRANCO
BLANCO
WHITECORES STANDARD
COLORES STANDARD
STANDARD COLORSCORES ESPECIAIS
COLORES ESPECIALES
SPECIAL COLORS

XX=

00

23 / 47 / 48

PÁG. 8

(60x40x10 cm)

78897xx2C

220 €

385 €

440 €

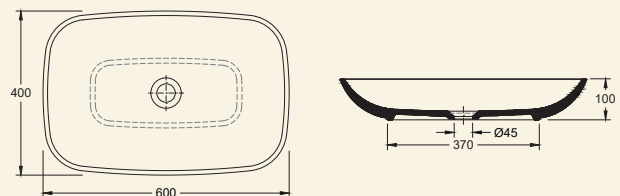

PICASSO

REF

BRANCO
BLANCO
WHITE

CORES STANDARD
COLORES STANDARD
STANDARD COLORS

CORES ESPECIAIS
COLORES ESPECIALES
SPECIAL COLORS

XX=

00

23 / 47 / 48

PÁG. 8

(50x30x13 cm)

78357xx2K

360 €

629 €

719 €

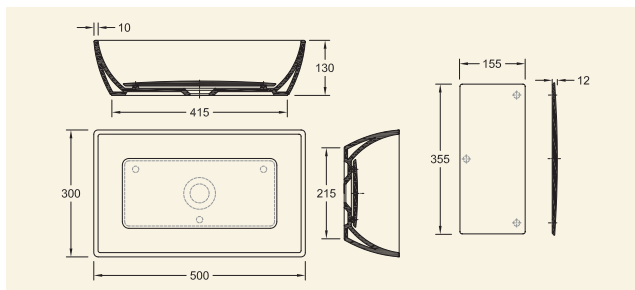

Complementos incluidos | Complementos incluidos | Included complements 78358002

100

REF

BRANCO
BLANCO
WHITE

CORES STANDARD
COLORES STANDARD
STANDARD COLORS

CORES ESPECIAIS
COLORES ESPECIALES
SPECIAL COLORS

XX=

00

23 / 47 / 48

PÁG. 8

(Ø 40x14 cm)

42350xx2C

193 €

338 €

386 €

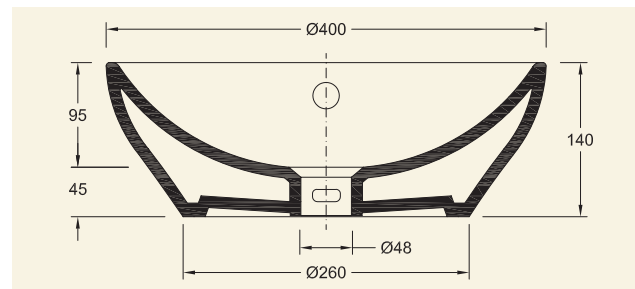

MACAU

REF

BRANCO
BLANCO
WHITE

CORES STANDARD
COLORES STANDARD
STANDARD COLORS

CORES ESPECIAIS
COLORES ESPECIALES
SPECIAL COLORS

XX=

00

23 / 47 / 48

PÁG. 8

(41x41x10 cm)

78857xx2C

166 €

291 €

333 €

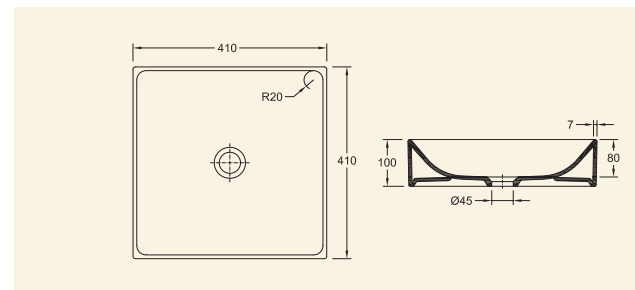

RECIFE PLUS V4**REF**BRANCO
BLANCO
WHITECORES STANDARD
COLORES STANDARD
STANDARD COLORSCORES ESPECIAIS
COLORES ESPECIALES
SPECIAL COLORS

XX=

00

23 / 47 / 48

PÁG. 8

(45x45x11 cm)

78764xx2C

122 €

213 €

243 €

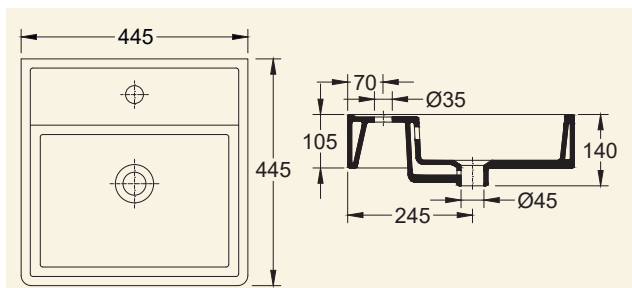
**EGG****REF**BRANCO
BLANCO
WHITECORES STANDARD
COLORES STANDARD
STANDARD COLORSCORES ESPECIAIS
COLORES ESPECIALES
SPECIAL COLORS

XX=

00

23 / 47 / 48

PÁG. 8

(50x38x12 cm)

39357xx2C

194 €

341 €

389 €

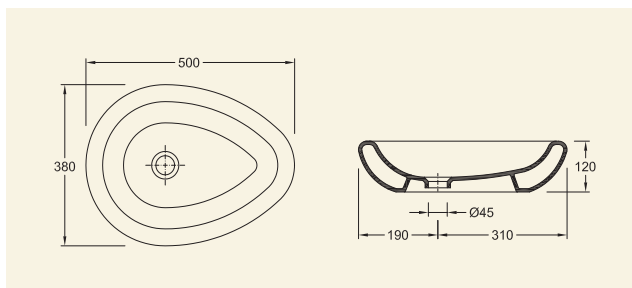
**SAVOY****REF**BRANCO
BLANCO
WHITECORES STANDARD
COLORES STANDARD
STANDARD COLORSCORES ESPECIAIS
COLORES ESPECIALES
SPECIAL COLORS

XX=

00

23 / 47 / 48

PÁG. 8

(50x40x15 cm)

18890xx2C

328 €

575 €

656 €

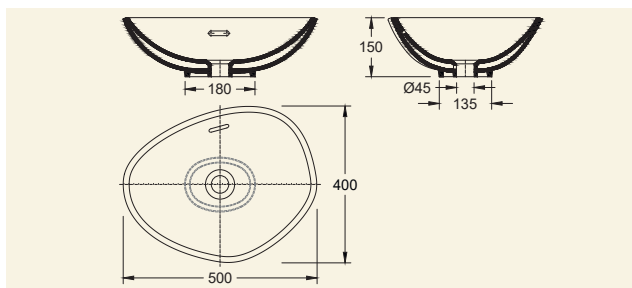

ONE SLIM

REF

BRANCO
BLANCO
WHITE

CORES STANDARD
COLORES STANDARD
STANDARD COLORS

CORES ESPECIAIS
COLORES ESPECIALES
SPECIAL COLORS

XX=

00

23 / 47 / 48

PÁG. 8

(47x35x13 cm)

40357xx2C

197 €

344 €

393 €

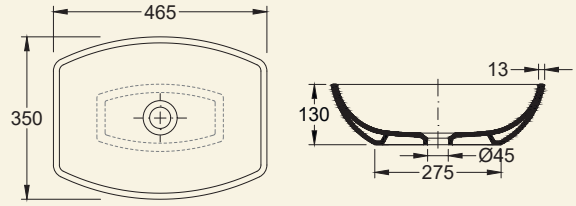

MALIBU

REF

BRANCO
BLANCO
WHITE

CORES STANDARD
COLORES STANDARD
STANDARD COLORS

CORES ESPECIAIS
COLORES ESPECIALES
SPECIAL COLORS

XX=

00

23 / 47 / 48

PÁG. 8

(Ø 42x13 cm)

78737xx2C

152 €

266 €

304 €

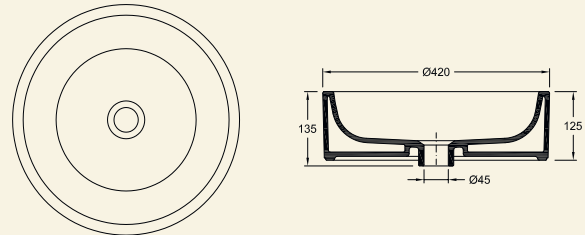

TAITI

REF

BRANCO
BLANCO
WHITE

CORES STANDARD
COLORES STANDARD
STANDARD COLORS

CORES ESPECIAIS
COLORES ESPECIALES
SPECIAL COLORS

XX=

00

23 / 47 / 48

PÁG. 8

(Ø 42x13 cm)

78731xx2C

152 €

265 €

303 €

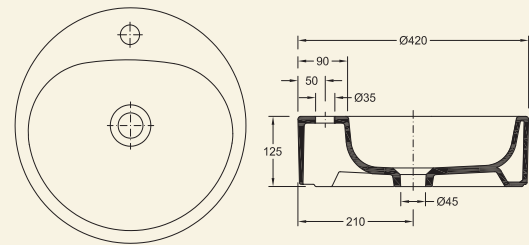

ZEN	REF	BRANCO BLANCO WHITE	CORES STANDARD COLORES STANDARD STANDARD COLORS	CORES ESPECIAIS COLORES ESPECIALES SPECIAL COLORS
-----	-----	---------------------------	---	---

XX= 00 23 / 47 / 48 PÁG. 8

(Ø 44x21 cm)

79920xx2C

384 €

672 €

769 €

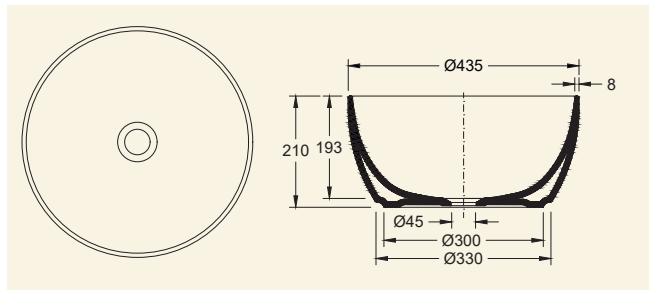

BOSTON	REF	BRANCO BLANCO WHITE	CORES STANDARD COLORES STANDARD STANDARD COLORS	CORES ESPECIAIS COLORES ESPECIALES SPECIAL COLORS
--------	-----	---------------------------	---	---

XX= 00 23 / 47 / 48 PÁG. 8

(Ø 41x16 cm)

18717xx2C

114 €

200 €

228 €

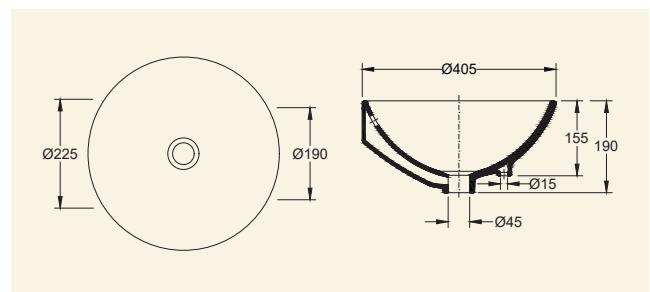

URANO	REF	BRANCO BLANCO WHITE	CORES STANDARD COLORES STANDARD STANDARD COLORS	CORES ESPECIAIS COLORES ESPECIALES SPECIAL COLORS
-------	-----	---------------------------	---	---

XX= 00 23 / 47 / 48 PÁG. 8

(Ø 44x10 cm)

18871xx2C

144 €

251 €

288 €

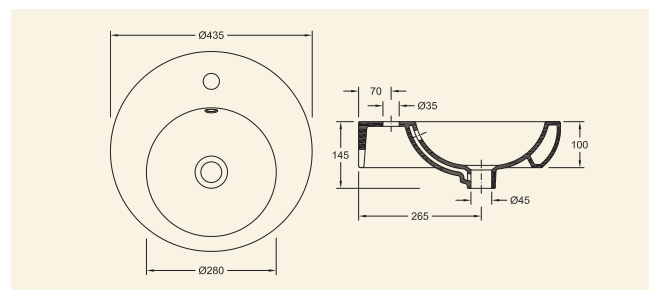

DARK

REF

BRANCO
BLANCO
WHITE

CORES STANDARD
COLORES STANDARD
STANDARD COLORS

CORES ESPECIAIS
COLORES ESPECIALES
SPECIAL COLORS

XX=

00

23 / 47 / 48

PÁG. 8

(Ø 40x13 cm)

18797xx2C

184 €

323 €

369 €

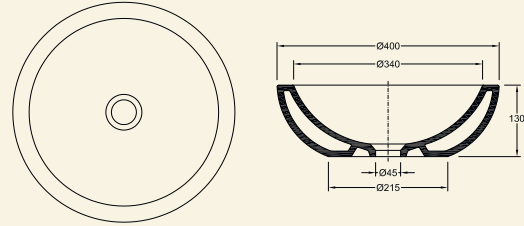

TICIANO

REF

BRANCO
BLANCO
WHITE

CORES STANDARD
COLORES STANDARD
STANDARD COLORS

CORES ESPECIAIS
COLORES ESPECIALES
SPECIAL COLORS

XX=

00

23 / 47 / 48

PÁG. 8

(45x33x13 cm)

78891xx2C

309 €

540 €

616 €

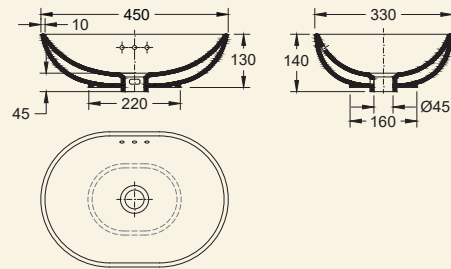

MIAMI

REF

BRANCO
BLANCO
WHITE

(63x49x13 cm)

18701002C

157 €

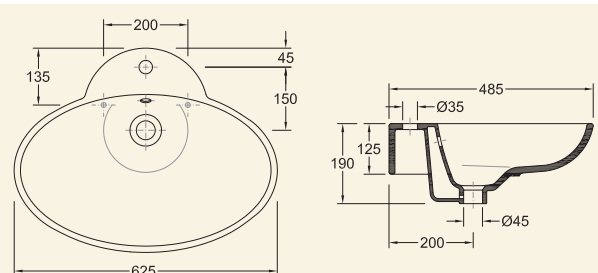

GOA

REF

BRANCO
BLANCO
WHITE

(Ø 43x21 cm)

78707002C

118 €

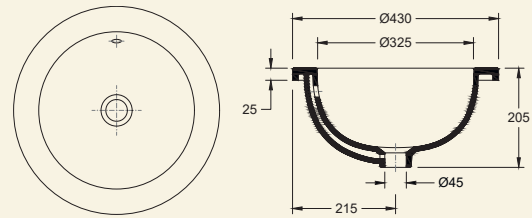

MIRAMAR

REF

BRANCO
BLANCO
WHITE

(57x50x22 cm)

18361002C

71 €

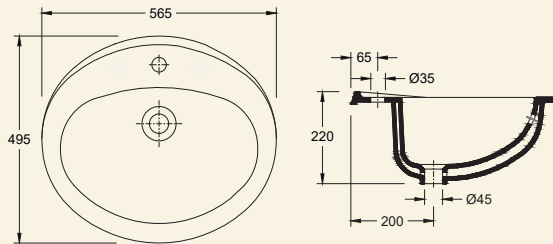

PALM

REF

BRANCO
BLANCO
WHITE

(Ø 40x13 cm)

18807002C

172 €

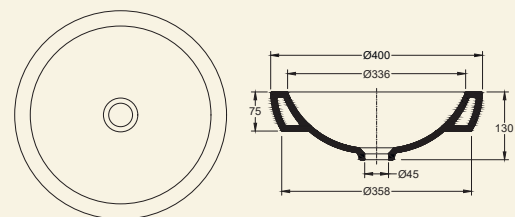

OÁSIS C/ TORNEIRA AO CENTRO

REF

BRANCO
BLANCO
WHITE

Oásis con grifo al centro
Oásis with centered tap hole
(57x46x17 cm)

18841002C

159 €

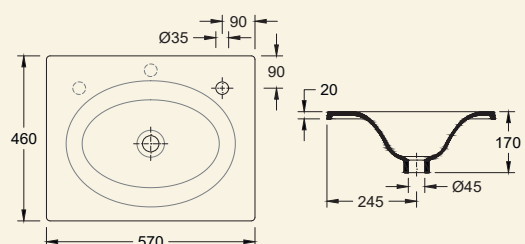

BARI**REF**BRANCO
BLANCO
WHITEPRETO
NEGRO
BLACK

XX=

00

48

(50x35x14 cm)

18881xx2C

168 €

293 €

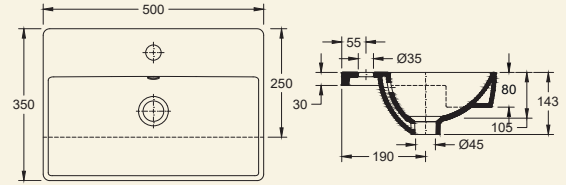
**TORINO****REF**BRANCO
BLANCO
WHITE

(67x51x20 cm)

18341002C

180 €

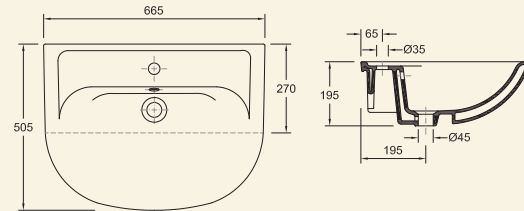
**ROMA****REF**BRANCO
BLANCO
WHITE

(50x42x13 cm)

18751002C

85 €

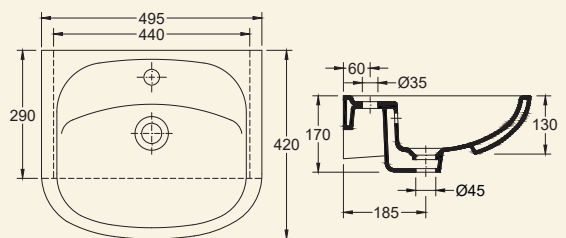

OVAL

REF

BRANCO
BLANCO
WHITE

(58x46x21 cm)

18327002C

63 €

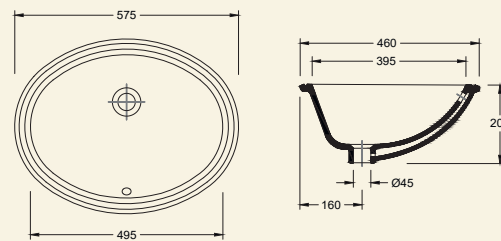

NICE

REF

BRANCO
BLANCO
WHITE

(Ø 37x20 cm)

18381002C

87 €

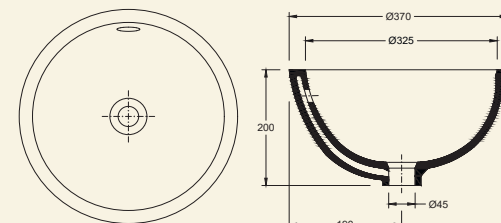

MISSOURI

REF

BRANCO
BLANCO
WHITE

(54x42x18 cm)

18767002C

80 €

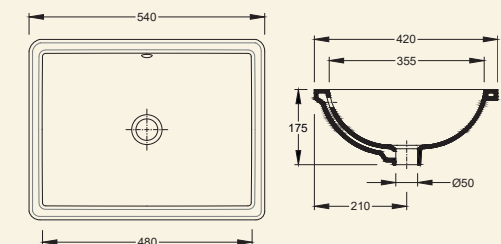

DALI

REF

BRANCO
BLANCO
WHITECORES STANDARD
COLORES STANDARD
STANDARD COLORS

(Ø 47x18 cm)

18887xx2C

XX= 00

23 / 47 / 48

115 €

202 €

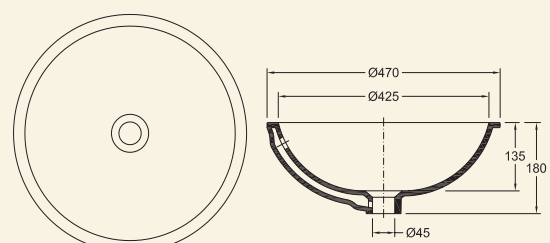

TOLEDO

REF

BRANCO
BLANCO
WHITE

CORES STANDARD
COLORES STANDARD
STANDARD COLORS

XX=

00

23 / 47 / 48

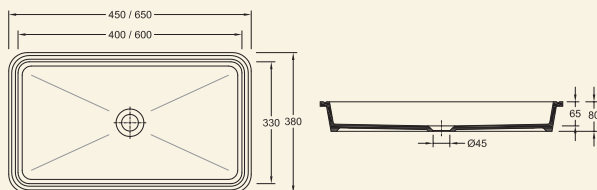

(65x38x8 cm)

78868xx2C

130 €

227 €

(45x38x8 cm)

78848xx2C

140 €

245 €

TÂNGER

REF

BRANCO
BLANCO
WHITE

CORES STANDARD
COLORES STANDARD
STANDARD COLORS

XX=

00

23 / 47 / 48

(55x35x16 cm)

18777xx2C

74€

128€

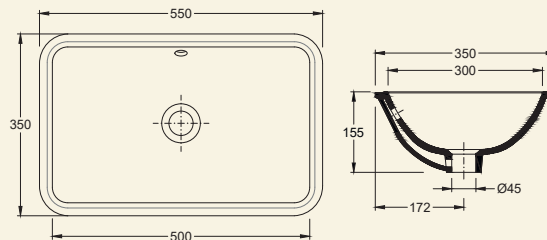

TÂNGER S

REF

BRANCO
BLANCO
WHITE

CORES STANDARD
COLORES STANDARD
STANDARD COLORS

XX=

00

23 / 47 / 48

(50x34x16 cm)

18775xx2C

74 €

128 €

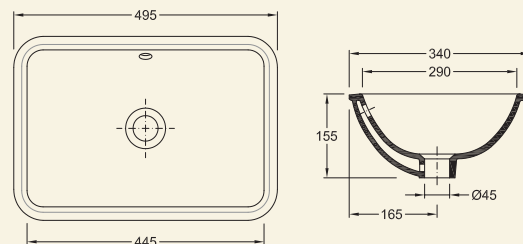

PLACA CERÂMICA P/ LAVATÓRIO PICASSO

REF

BRANCO
BLANCO
WHITE

CORES STANDARD
COLORES STANDARD
STANDARD COLORS

CORES ESPECIAIS
COLORES ESPECIALES
SPECIAL COLORS

Plato en cerâmica para lavabo Picasso
Ceramic cover for washbasin Picasso
(36x16x1 cm)

XX=

00

23 / 47 / 48

PÁG. 8

78358xx2

69 €

121 €

138 €

RALO CERÂMICO (LAVATÓRIO RUBENS)

REF

BRANCO
BLANCO
WHITE

CORES STANDARD
COLORES STANDARD
STANDARD COLORS

CORES ESPECIAIS
COLORES ESPECIALES
SPECIAL COLORS

Desagüe cerâmico (lavabo Rubens)
Ceramic drain (washbasin Rubens)
(36x16x1 cm)

XX=

00

23 / 47 / 48

PÁG. 8

20925xx2

32 €

54 €

62 €

KIT FIXAÇÃO Nº1

REF

Kit de fijación nº1
Fixing kit nº1

55007001

6 €

KIT FIXAÇÃO P/ LAV. 3 FUROS

REF

Kit de fijación p/ lav. 3 orificios
Fixing kit for washbasin 3 holes

55007320

6 €

SIFÃO QUADRADO

REF

CROMADO
CROMO
CHROME

PRETO MATE
NEGRO MATE
BLACK MATT

Sifón cuadrado
Square siphon

X=

2

3

5510914x

78€

158€

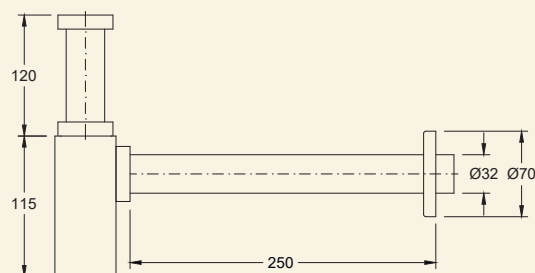

VÁLVULA CLIC-CLAC COM TAMPA CERÂMICA

REF

CROMADO-BRANCO
CROMO-BLANCO
CHROME-WHITE

CORES STANDARD
COLORES STANDARD
STANDARD COLORS

VCC con tapa cerâmica
VCC with ceramic cover

XX=

00

22 / 47 / 48

55110022xx

59€

78€

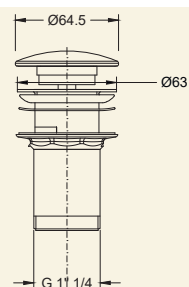



VÁLVULA CLIC-CLAC REF CROMADO CROMO CHROME PRETO MATE NEGRO MATE BLACK MATT

Válvula clic-clac
Pop-up waste

5511002x

X= 2 3

20€ 28€

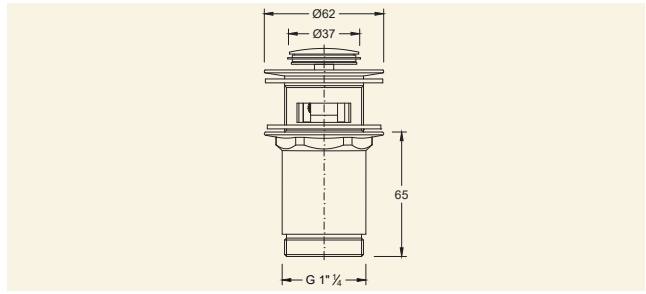

VÁLVULA CLIC-CLAC C/ TAMPA QUADRADA REF BRANCO BLANCO WHITE PRETO MATE NEGRO MATE BLACK MATT

Válvula clic-clac c/ tapa quadrada
Pop-up waste w/ square cover

5511005x

X= 2 3

60€ 87€

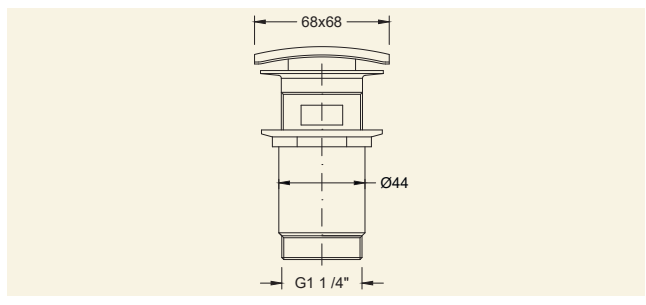

VÁLVULA CLIC-CLAC (KOBÉ) REF

Válvula clic-clac (Kobe)
Pop-up waste (Kobe)

55110042

22 €

KIT DE DESCARGA (KOBÉ) REF

Kit de descarga (Kobe)
Discharge kit (Kobe)

55023052

41 €

PRATELEIRA CERÂMICA P/ ESTRUTURA DE LAVATÓRIO SERRAS REF BRANCO BLANCO WHITE CORES STANDARD COLORES STANDARD STANDARD COLORS CORES ESPECIAIS COLORES ESPECIALES SPECIAL COLORS

Estante de cerâmica para estrutura de lavabo Serras
Ceramic shelf for Serras washbasin structure

21500xx2

XX= 00 23 / 47 / 48 PÁG. 8

74 € 129 € 147 €

KIT FIXAÇÃO P/ LAVATÓRIOS DE ENCASTRAR REF

Kit de fijación para lavabos de bajo encimera

Fixing kit for built-embedded washbasins 55150110

21 €

SIFÃO CILÍNDRICO

REF

CROMADO
CROMO
CHROME

Sifón cilíndrico
Cilindric siphon

55109132

45 €

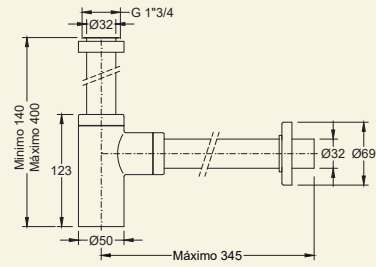

SIFÃO DE GARRAFA

REF

CROMADO
CROMO
CHROME

Sifón
Siphon

55109162

22 €

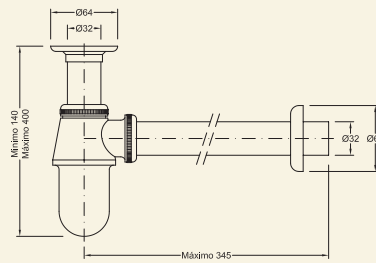

TUBO FLÉXIVEL

REF

PLÁSTICO
PLASTICO
PLASTIC

Tubo flexible
Flexible tube

55079000

10 €

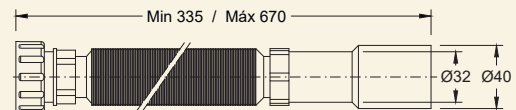



MÓVEIS
MUEBLES
FURNITURE

PLACAS CERÂMICAS 106
ENCIMERAS CERÁMICA
CERAMIC TOPS

ESTRUTURA DE BANCADA 107
ESTRUCTURAS DE ENCIMERA
TOP FRAMES STRUCTURES

MÓVEIS 113
MUEBLES
FURNITURE



PLACAS CERÂMICAS | ENCIMERAS CERÁMICA | CERAMIC TOPS

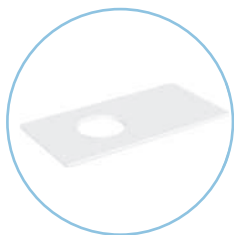

PAG 106

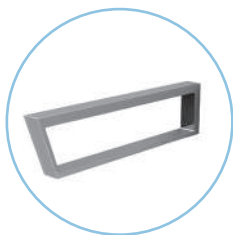

PAG 106

ESTRUTURAS BANCADA | ESTRUCTURAS DE ENCIMERA | TOP FRAMES STRUCTURES



PAG 107



PAG 107



PAG 107



PAG 108



PAG 108

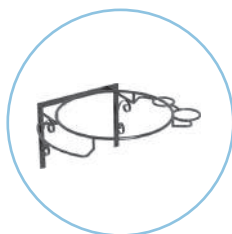

PAG 108



PAG 109



PAG 109

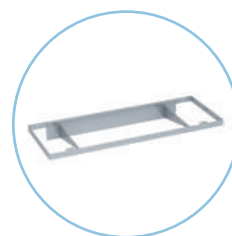

PAG 109



PAG 110

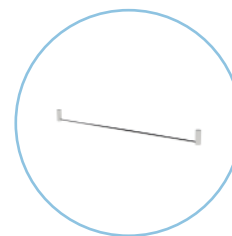

PAG 110

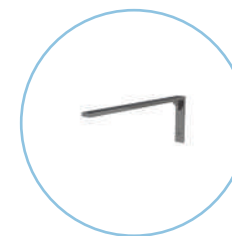

PAG 110

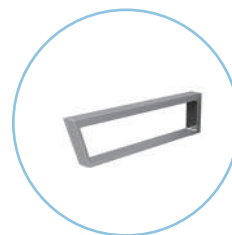

PAG 111

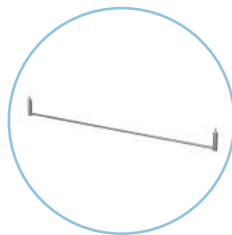

PAG 111

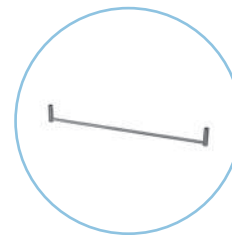

PAG 112

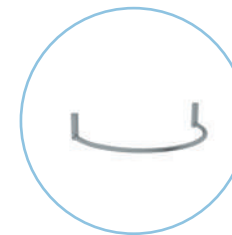

PAG 112

MÓVEIS | MUEBLES | FURNITURE



PAG 113

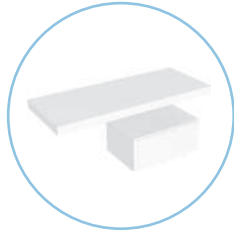

PAG 114

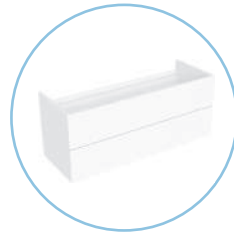

PAG 115

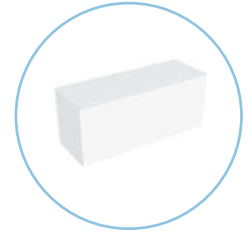

PAG 116



PLACAS CERÂMICAS

REF

BRANCO
BLANCO
WHITE

CORES STANDARD
COLORES STANDARD
STANDARD COLORS

CORES ESPECIAIS
COLORES ESPECIALES
SPECIAL COLORS

XX=

00

23 / 47 / 48

PÁG. 8

Encimeras en cerámica
Ceramic tops

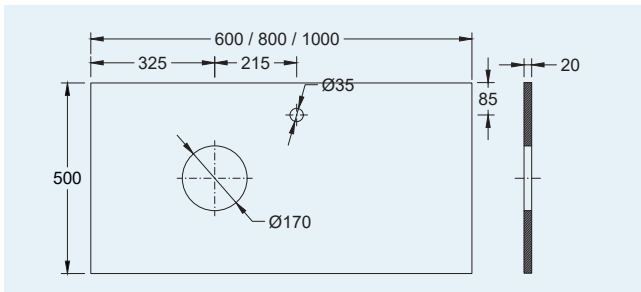

Size	REF	BRANCO / BLANCO / WHITE	CORES STANDARD / COLORES STANDARD / STANDARD COLORS	CORES ESPECIAIS / COLORES ESPECIALES / SPECIAL COLORS
100x50	70240xx2C	250 €	437 €	500 €
80x50	70140xx2C	219 €	384 €	438 €
60x50	70040xx2C	175 €	308 €	350 €

As placas cerâmicas têm opções de furação sob consulta
Las encimeras cerámicas tienen opciones de perforación bajo pedido
Ceramic tops have drilling options under request

SUORTES FIXAÇÃO COM TOALHEIROS LATERAIS

REF

CROMADO
CROMO
CHROME

PRETO
NEGRO
BLACK

X = 2

X = 3

Soportes de fijación inox pulido para lavabos
Fixing supports in polished stainless steel for washbasin

5518115x

195 €

243 €

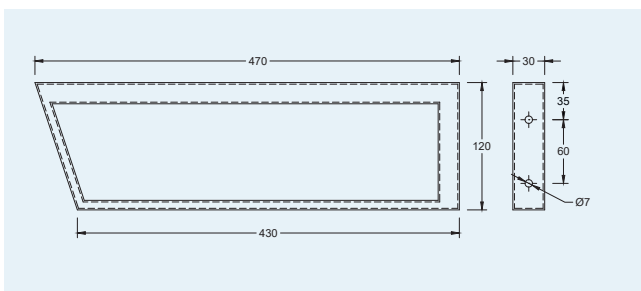

PRATELEIRAS CERÂMICAS P/ APOLO

REF

BRANCO
BLANCO
WHITE

CORES STANDARD
COLORES STANDARD
STANDARD COLORS

CORES ESPECIAIS
COLORES ESPECIALES
SPECIAL COLORS

XX=

00

23 / 47 / 48

PÁG. 8

Estantes cerâmicas p/ Apolo
Ceramic shelves f/ Apolo

Size	REF	BRANCO / BLANCO / WHITE	CORES STANDARD / COLORES STANDARD / STANDARD COLORS	CORES ESPECIAIS / COLORES ESPECIALES / SPECIAL COLORS
35 cm	70110xx2	85 €	149 €	170 €
30 cm	70100xx2	85 €	149 €	170 €
25 cm	70090xx2	70 €	123 €	141 €

LIS**REF**

CRYSTAL WHITE

NEGRO ABSOLUTO
ABSOLUTE BLACKOUTRAS PEDRAS
OTRAS PIEDRAS
OTHER STONES

X= 0

1

2/3/4/5/6

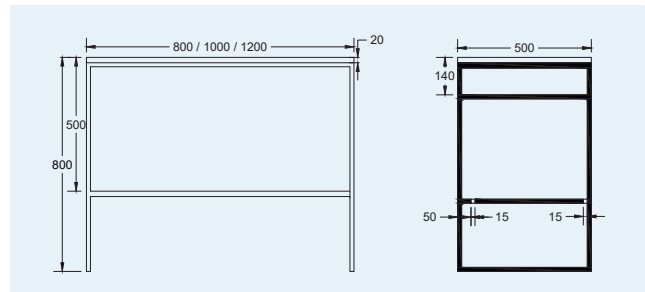

Size	Reference	Crystal White	Absolute Black	Other Stones
120 (120x50 cm)	5289x123	1.392 €	1.392 €	1.500 €
100 (100x50 cm)	5289x103	1.112 €	1.132 €	1.213 €
80 (80x50 cm)	5289x083	1.022 €	1.039 €	1.110 €

Estrutura em preto | Estructura negra | Black structure

LENA**REF**

CRYSTAL WHITE

NEGRO ABSOLUTO
ABSOLUTE BLACKOUTRAS PEDRAS
OTRAS PIEDRAS
OTHER STONES

X= 0

1

2/3/4/5/6

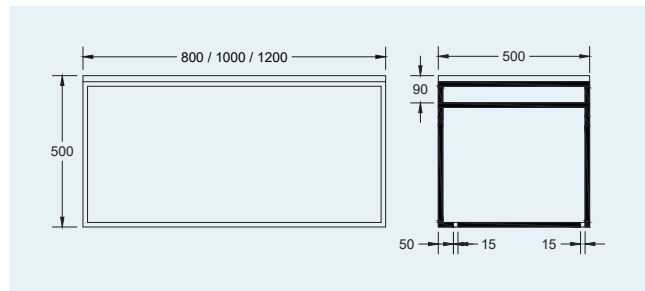

Size	Reference	Crystal White	Absolute Black	Other Stones
120 (120x50 cm)	5288x123	1.307 €	1.336 €	1.444 €
100 (100x50 cm)	5288x103	1.056 €	1.076 €	1.157 €
80 (80x50 cm)	5288x083	966 €	983 €	1.054 €

Estrutura em preto | Estructura negra | Black structure

ONOR**REF**

CRYSTAL WHITE

NEGRO ABSOLUTO
ABSOLUTE BLACKOUTRAS PEDRAS
OTRAS PIEDRAS
OTHER STONES

X= 0

1

2/3/4/5/6

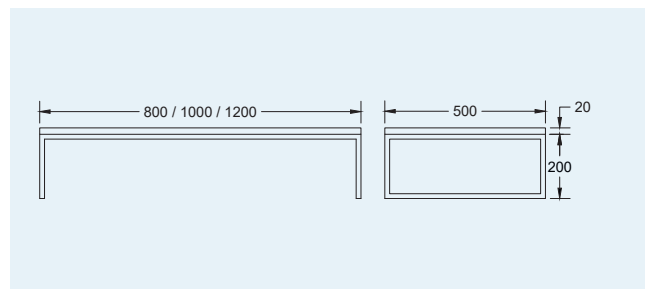

Size	Reference	Crystal White	Absolute Black	Other Stones
120 (120x50 cm)	5287x123	850 €	850 €	927 €
100 (100x50 cm)	5287x103	672 €	684 €	731 €
80 (80x50 cm)	5287x083	571 €	581 €	623 €

Estrutura em preto | Estructura negra | Black structure

ESTRUTURAS APOLO

REF

CROMADO
CROMO
CHROME

DOURADO*
DORADO*
GOLDEN*

DOURADO MATE*
ORO MATE*
MATT GOLD*

Estruturas Apolo
Consoles Apolo



X = 2

X = 4

X = 5

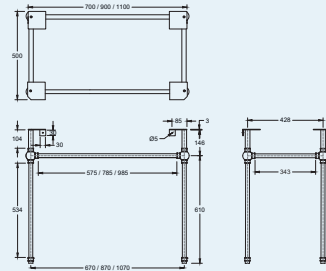

Height	Reference	Cromado Cromo Chrome	Dourado* Dorado* Golden*	Dourado Mate* Oro Mate* Matt Gold*
120	5070004x	1.694 €	2.033 €	2.033 €
100	5070003x	1.666 €	1.999 €	1.999 €
80	5070002x	1.582 €	1.899 €	1.899 €

* Acabamentos com produção mediante encomenda | * Acabados a medida | * Custom-made finishes

ESTRUTURA DE PÉ (LAVATÓRIO EMBUTIR E SERRAS)

REF

BRANCO
BLANCO
WHITE

PRETO
NEGRO
BLACK

Estrutura de pie (lavabos sobre encimera y Serras)
Console (embedded and Serras washbasins)

5518201x

X = 1

X = 3

375 €

375 €

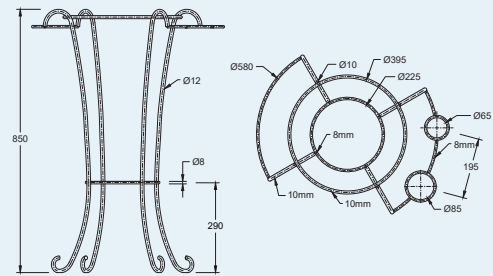

Complementos não incluídos | Complementos no incluidos | Not included complements
Ver pág. 85 | See page 85

ESTRUTURA SUSPensa (LAVATÓRIO EMBUTIR E SERRAS)

REF

BRANCO
BLANCO
WHITE

PRETO
NEGRO
BLACK

Estrutura suspensa (lavabos sobre encimera y Serras)
Wall hang Console (embedded and Serras washbasins)

5518203x

X = 1

X = 3

375 €

375 €

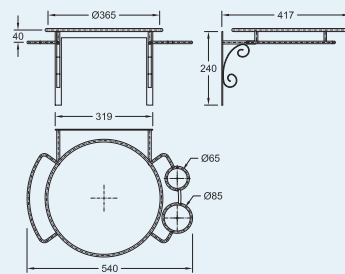
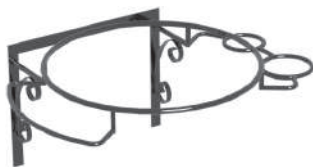

Complementos não incluídos | Complementos no incluidos | Not included complements
Ver pág. 85 | See page 85

ESTRUTURAS P/ LAVATÓRIOS RAFAEL E PLATINIUM

REF

CROMADO
CROMO
CHROMEPRETO
NEGRO
BLACK

Estructuras para lavabos Rafael e Platinum
Structures for Rafael and Platinum washbasins



X = 2

X = 3

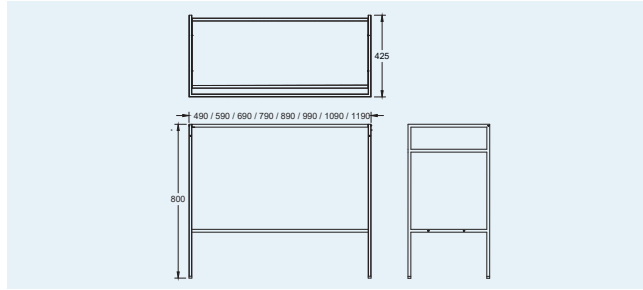

120	5518912x	420 €	525 €
110	5518911x	406 €	508 €
100	5518910x	392 €	490 €
90	5518909x	378 €	473 €
80	5518908x	364 €	455 €
70	5518907x	350 €	438 €
60	5518906x	336 €	420 €
50	5518905x	336 €	420 €

ESTRUTURA PARA LAVATÓRIO RETANGULAR DE EMBUTIR

REF

CROMADO
CROMO
CHROME

Estrutura de lavabo rectangular sobre encimera
Console for embedded rectangular washbasin

55182000

423 €

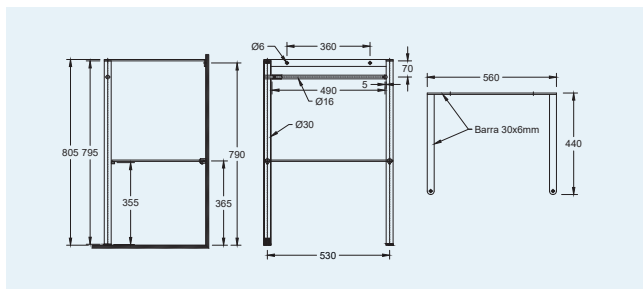
**ESTRUTURAS P/ LAVATÓRIOS RAFAEL**

REF

CROMADO
CROMO
CHROMEPRETO
NEGRO
BLACK

Estructuras para lavabos Rafael
Structures for Rafael washbasins



X = 2

X = 3

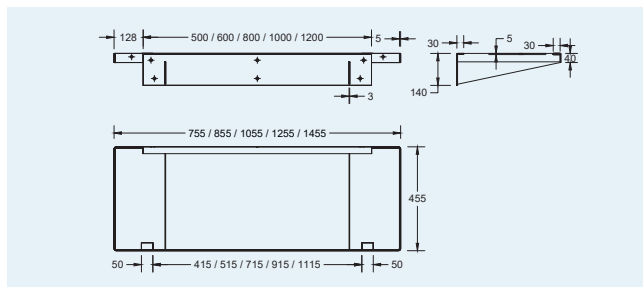

120	5518138x	523 €	654 €
100	5518136x	523 €	654 €
80	5518134x	488 €	610 €
60	5518132x	477 €	569 €
50	5518131x	477 €	569 €

PRATELEIRAS C/ SUPORTES P/ LAVATORIOS RAFAEL

REF

CROMADO CROMO CHROME

PRETO NEGRO BLACK

Estantes c/ soportes para lavabos Rafael
Shelfs w/ support for Rafael washbasins



x = 2

x = 3

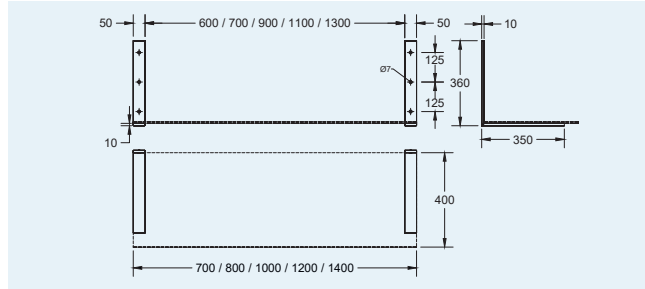

120	5518148x	262 €	344 €
100	5518146x	238 €	312 €
80	5518144x	214 €	280 €
60	5518142x	188 €	247 €
50	5518141x	188 €	247 €

TOALHEIROS PLATINIUM

REF

CROMADO CROMO CHROME

PRETO NEGRO BLACK

Toalleros Platinum
Platinum towel rails



x = 2

x = 3

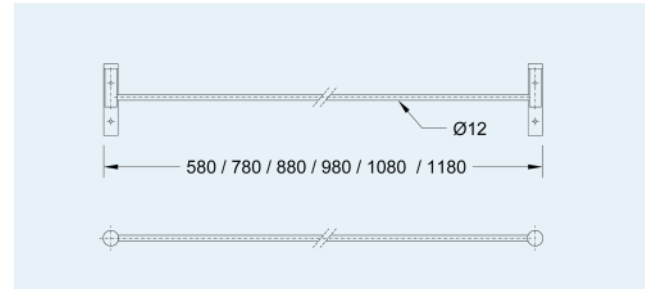

Para serem montados nos suportes 55181100
Para seren montados en los soportes 55181100
To be mounted on the supports 55181100

120	5517412x	104 €	158 €
110	5517411x	56 €	86 €
100	5517410x	56 €	86 €
90	5517409x	54 €	83 €
80	5517419x	54 €	83 €
60	5517406x	54 €	83 €

SUPORTES DE FIXAÇÃO PLATINIUM

REF

CROMADO CROMO CHROME

PRETO NEGRO BLACK

Soportes de fijación
Platinum
Fixing supports Platinum

5518110x

x = 2

x = 3

141 €	211 €
-------	-------

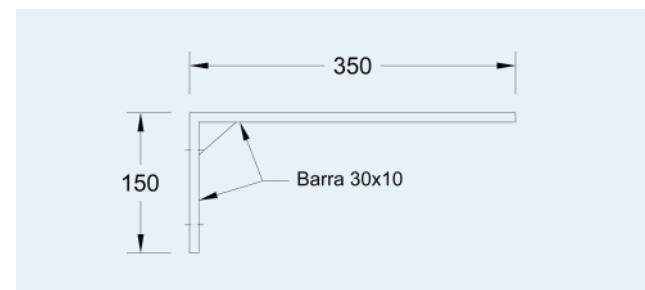

SUPORTE FIXAÇÃO COM TOALHEIROS LATERAIS

REF

CROMADO
CROMO
CHROME

PRETO
NEGRO
BLACK

Soporte de fijación con toalleros laterales
laterales
Fixing supports with side towel rails

x = 2

x = 3

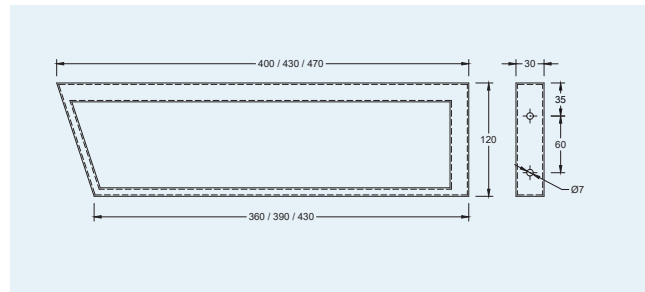

Platinum (40 cm)

5518116x

195 €

243 €

Rafael (43 cm)

5518113x

195 €

243 €

Placa Cerâmica | Encimera en cerâmica | Ceramic Top (47 cm)

5518115x

195 €

243 €

TOALHEIROS ONE LINE

REF

CROMADO
CROMO
CHROME

PRETO
NEGRO
BLACK

Toalleros ONE LINE
ONE LINE towel rails

x = 2

x = 3

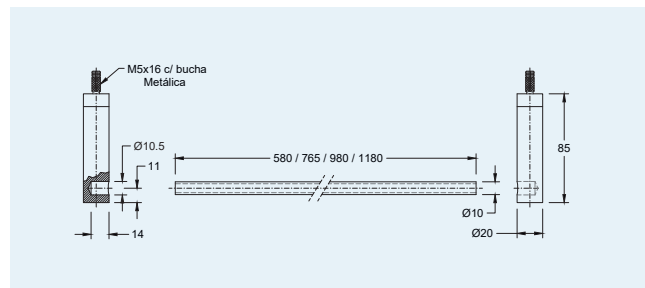

120

5517414x

113 €

141 €

100

5517413x

110 €

137 €

90

5517405x

107 €

134 €

80

5517415x

104 €

130 €

70

5517402x

101 €

126 €

60

5517407x

101 €

126 €

TOALHEIRO GALLERY

REF

CROMADO
CROMO
CHROME

Toallero Gallery
Gallery towel rail

55174010

51 €

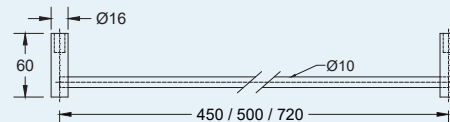

TOALHEIRO FRONTAL 72 CM

Toallero frontal 72 cm
Front towel rail 72 cm

55174030

70 €

TOALHEIRO FRONTAL 53 CM

Toallero frontal 53 cm
Front towel rail 53 cm

55174040

51 €

TOALHEIRO CEUTA

REF

CROMADO
CROMO
CHROME

Toallero Ceuta
Ceuta towel rail

55174002

45 €

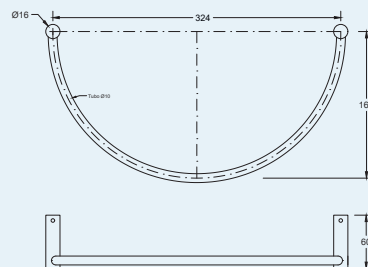

AVIZ C/ GAVETÃO E GAVETA INTERIOR

REF

BRANCO
BLANCO
WHITEPRETO BRILHO
NEGRO BRILHO
BLACK SHINE

AVIZ c/ cajón y cajón interior
AVIZ w/ external drawer and interior
drawer

XX=

00

48

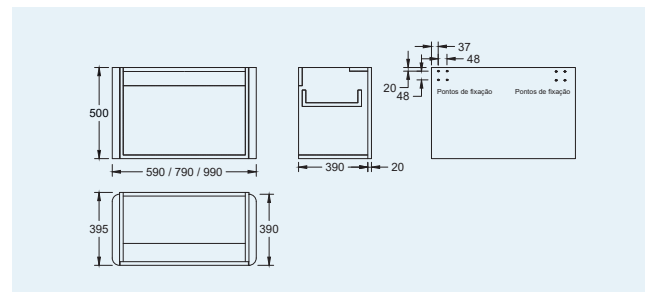

100 (100x50x40 cm)	52865xx4	940 €	1.032 €
80 (80x50x40 cm)	52865xx2	906 €	986 €
60 (60x50x40 cm)	52865xx1	878 €	952 €

AVIZ C/ GAVETÃO

AVIZ c/ cajón
AVIZ w/ external drawer

100 (100x50x40 cm)	52805xx4	769 €	860 €
80 (80x50x40 cm)	52805xx2	743 €	823 €
60 (60x50x40 cm)	52805xx1	722 €	795 €

AVIZ C/ 2 PORTAS

AVIZ c/ 2 puertas
AVIZ w/ 2 doors

100 (100x50x40 cm)	52806xx4	695 €	786 €
80 (80x50x40 cm)	52806xx2	671 €	750 €
60 (60x50x40 cm)	52806xx1	648 €	722 €

BANCADA

REF

BRANCO
BLANCO
WHITE

PRETO BRILHO
NEGRO BRILHO
BLACK SHINE

NOGUEIRA
NOGAL
WALNUT

XX=

00

48

76

Bancada
Washbasin Top

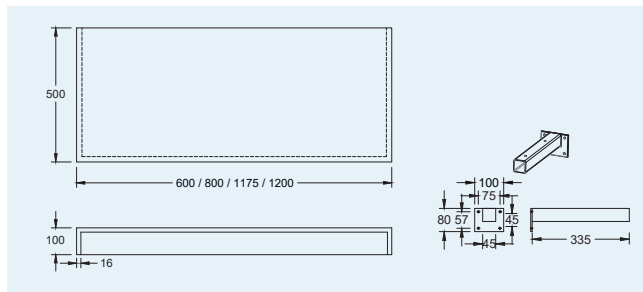

120 (120x50x10 cm)	52815xx4	424 €	501 €	501 €
100 (100x50x10 cm)	52815xx3	385 €	443 €	443 €
80 (80x50x10 cm)	52815xx2	324 €	403 €	403 €
60 (60x50x10 cm)	52815xx1	310 €	351 €	351 €

MÓDULO C/ GAVETA

Módulo con cajón
Module w/ drawer

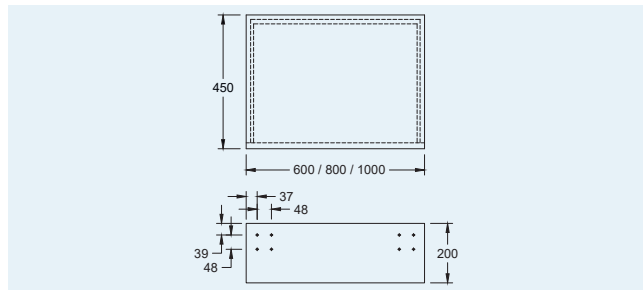

100 (100x50x30 cm)	52817xx3	439 €	544 €	544 €
80 (80x50x30 cm)	52817xx2	402 €	499 €	499 €
60 (60x50x30 cm)	52817xx1	378 €	462 €	462 €

BOX SEM TAMPO, COM GAVETÃO E GAVETA INTERIOR

REF

BRANCO
BLANCO
WHITEPRETO BRILHO
NEGRO BRILHO
BLACK SHINENOGUEIRA
NOGAL
WALNUT

Box sin encimera, con gavetón y cajón interior
Box without top, w/ external drawer and interior drawer

XX=

00

48

76



Dimensões (cm)	Modelo	BRANCO BLANCO WHITE	PRETO BRILHO NEGRO BRILHO BLACK SHINE	NOGUEIRA NOGAL WALNUT
120x43 (120x43x50 cm)	52846xx6C/D/E	822 €	864 €	864 €
110x43 (110x43x50 cm)	52846xx5C/D/E	804 €	848 €	848 €
100x43 (100x43x50 cm)	52846xx4C/D/E	676 €	717 €	717 €
90x43 (90x43x50 cm)	52846xx3C/D/E	658 €	699 €	699 €
80x43 (80x43x50 cm)	52846xx2C/D/E	639 €	676 €	676 €
60x43 (60x43x50 cm)	52846xx1	609 €	647 €	647 €

BOX SEM TAMPO E COM GAVETÃO

Box sin encimera y con cajón
Box without top, w/ external drawer

Dimensões (cm)	Modelo	BRANCO BLANCO WHITE	PRETO BRILHO NEGRO BRILHO BLACK SHINE	NOGUEIRA NOGAL WALNUT
120x43 (120x43x50 cm)	52826xx6	559 €	600 €	600 €
110x43 (110x43x50 cm)	52826xx5	546 €	591 €	591 €
100x43 (100x43x50 cm)	52826xx4	495 €	536 €	536 €
90x43 (90x43x50 cm)	52826xx3	481 €	521 €	521 €
80x43 (80x43x50 cm)	52826xx2	467 €	504 €	504 €
60x43 (60x43x50 cm)	52826xx1	445 €	481 €	481 €

BOX SEM TAMPO COM 2 GAVETAS

Box sin encimera y con 2 cajones
Box without top, w/ 2 external drawers

Dimensões (cm)	Modelo	BRANCO BLANCO WHITE	PRETO BRILHO NEGRO BRILHO BLACK SHINE	NOGUEIRA NOGAL WALNUT
120x43 (120x43x50 cm)	52842xx6C/D/E	822 €	864 €	864 €
110x43 (110x43x50 cm)	52842xx5C/D/E	804 €	848 €	848 €
100x43 (100x43x50 cm)	52842xx4C/D/E	676 €	717 €	717 €
90x43 (90x43x50 cm)	52842xx3C/D/E	658 €	699 €	699 €
80x43 (80x43x50 cm)	52842xx2C/D/E	639 €	676 €	676 €
60x43 (60x43x50 cm)	52842xx1	609 €	647 €	647 €

C - p/ lavatórios pio central | p/ lavabos cuba al centro | f/ washbasins centered sink
D - p/ lavatórios pio direito | p/ lavabos cuba derecha | f/ washbasins w/ right sink
E - p/ lavatórios pio esquerdo | p/ lavabos cuba izquierda | f/ washbasins w/ left sink

BOX COM TAMPO, COM GAVETÃO E GAVETA INTERIOR

REF

BRANCO
BLANCO
WHITEPRETO BRILHO
NEGRO BRILHO
BLACK SHINENOGUEIRA
NOGAL
WALNUT

Box com encimera, com cajón y cajón interior
Box with top, w/ external drawer and interior drawer

XX= 00 48 76

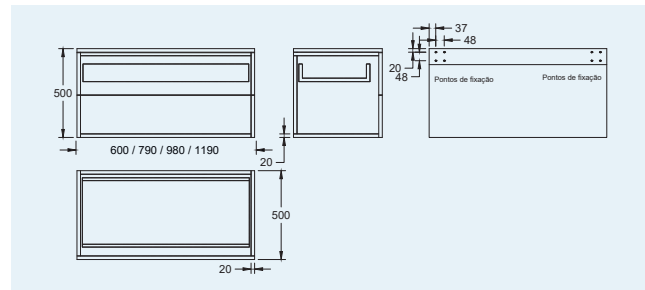

120x50 (120x50x50 cm)	52855xx6C/D/E	945 €	1.022 €	1.022 €
100x50 (100x50x50cm)	52855xx4C/D/E	788 €	864 €	864 €
80x50 (80x50x50 cm)	52855xx2C/D/E	732 €	805 €	805 €
60x50 (60x50x50 cm)	52855xx1C/D/E	690 €	763 €	763 €

BOX SEM TAMPO, COM GAVETÃO E GAVETA INTERIOR

Box sin encimera, con cajón y cajón interior
Box without top, w/ external drawer and interior drawer

120x50 (120x50x50 cm)	52845xx6C/D/E	822 €	864 €	864 €
100x50 (100x50x50cm)	52845xx4C/D/E	676 €	722 €	722 €
80x50 (80x50x50 cm)	52845xx2C/D/E	640 €	680 €	680 €
60x50 (60x50x50 cm)	52845xx1C/D/E	612 €	651 €	651 €

BOX COM TAMPO E COM GAVETÃO

Box con encimera y con cajón
Box with top, w/ external drawer

120x50 (120x50x50 cm)	52835xx6	684 €	762 €	762 €
100x50 (100x50x50cm)	52835xx4	608 €	682 €	682 €
80x50 (80x50x50 cm)	52835xx2	562 €	636 €	636 €
60x50 (60x50x50 cm)	52835xx1	522 €	596 €	596 €

BOX SEM TAMPO E COM GAVETÃO

Box sin encimera y con cajón
Box without top, w/ external drawer

120x50 (120x50x50 cm)	52825xx6	559 €	600 €	600 €
100x50 (100x50x50cm)	52825xx4	495 €	536 €	536 €
80x50 (80x50x50 cm)	52825xx2	467 €	504 €	504 €
60x50 (60x50x50 cm)	52825xx1	445 €	481 €	481 €

**BOX COM TAMPO E COM
2 GAVETAS**

REF

BRANCO
BLANCO
WHITEPRETO BRILHO
NEGRO BRILHO
BLACK SHINENOGUEIRA
NOGAL
WALNUTBox con encimera y con 2 cajones
Box with top, w/ 2 external drawers

XX=

00

48

76



120x50 (120x50x50 cm)	52847xx6C/D/E	945 €	1.022 €	1.022 €
100x50 (100x50x50 cm)	52847xx4C/D/E	788 €	864 €	864 €
80x50 (80x50x50 cm)	52847xx2C/D/E	732 €	805 €	805 €
60x50 (60x50x50 cm)	52847xx1C/D/E	690 €	763 €	763 €

**BOX SEM TAMPO E COM
2 GAVETAS**Box sin encimera y con 2 cajones
Box, without top, w/ 2 external
drawers

120x50 (120x50x50 cm)	52843xx6C/D/E	822 €	864 €	864 €
100x50 (100x50x50 cm)	52843xx4C/D/E	676 €	722 €	722 €
80x50 (80x50x50 cm)	52843xx2C/D/E	640 €	680 €	680 €
60x50 (60x50x50 cm)	52843xx1C/D/E	612 €	651 €	651 €

C - p/ lavatórios pio central | p/ lavabos cuba al centro | f/ washbasins centered sink
D - p/ lavatórios pio direito | p/ lavabos cuba derecha | f/ washbasins w/ right sink
E - p/ lavatórios pio esquerdo | p/ lavabos cuba izquierda | f/ washbasins w/ left sink





TORNEIRAS

GRIFERIA
TAPS

LUNA	130
LOTTO	137
FIDJI	144
LINE	150
CLASSIC	155
CAYENNE	160
OLO	167
SENSOR	171
TEMPORIZADAS TEMPORIZADOS TIMER TAPS	173
MISTURADORAS DE DUCHE COM COLUNA MEZCLADORES DE DUCHA DE COLUMNA COLUMN SHOWER MIXERS	180
ACESSÓRIOS DE DUCHE ACCESORIOS DE DUCHA SHOWER ACCESSORIES	183

LUNA



PAG 130



PAG 131



PAG 131



PAG 132



PAG 132



PAG 131



PAG 134



PAG 130



PAG 132



PAG 130



PAG 134



PAG 133



PAG 135



PAG 133

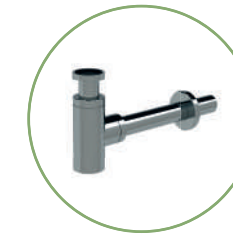

PAG 136

LOTTO



PAG 137



PAG 138



PAG 138



PAG 139



PAG 139



PAG 142



PAG 137



PAG 138



PAG 139



PAG 137



PAG 140



PAG 143



PAG 143



PAG 142



PAG 143



FIDJI



PAG 144



PAG 145



PAG 145



PAG 146



PAG 144



PAG 146



PAG 148



PAG 148



PAG 147



PAG 147



PAG 146



PAG 148



PAG 144



PAG 149



PAG 149



PAG 149



PAG 149



PAG 145

LINE



PAG 150



PAG 150

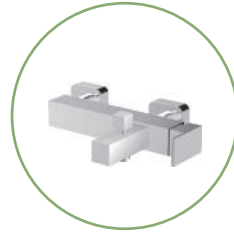

PAG 151

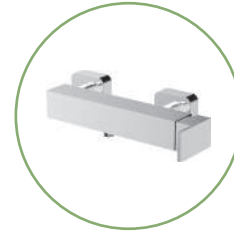

PAG 151



PAG 151



PAG 152



PAG 152



PAG 152



PAG 150



PAG 153



PAG 153



PAG 153



PAG 153



PAG 150



CLASSIC



PAG 155



PAG 155



PAG 156



PAG 156



PAG 157



PAG 156



PAG 155



PAG 157



PAG 157



PAG 156



PAG 155



PAG 158



PAG 158



PAG 158

CAYENNE



PAG 160



PAG 161



PAG 161



PAG 162



PAG 162



PAG 158



PAG 162



PAG 162



PAG 161



PAG 160



PAG 161



PAG 163

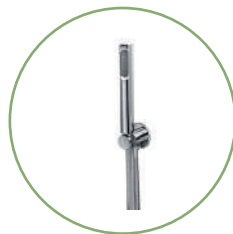

PAG 164



PAG 163



PAG 164



PAG 164



PAG 165



PAG 165



PAG 160



OLO



PAG 167



PAG 167



PAG 167



PAG 167



PAG 168



PAG 168



PAG 168



PAG 168



PAG 169



PAG 169



PAG 169



PAG 169



PAG 170



PAG 170



PAG 170

SENSOR



PAG 171



PAG 171



PAG 171



PAG 171



PAG 172

TEMPORIZADAS | TEMPORIZADOS | TIMER TAPS



PAG 175



PAG 173



PAG 174



PAG 176



PAG 174



PAG 175



PAG 177



PAG 176



PAG 175



PAG 173



PAG 174



PAG 174



TEMPORIZADAS | TEMPORIZADOS | TIMER TAPS



PAG 176



PAG 173



PAG 173



PAG 176

TERMOESTÁTICAS | TERMOSTATICOS | THERMOSTATICS



PAG 178



PAG 178

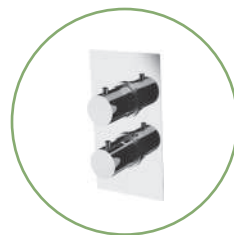

PAG 178

MISTURADORAS DE DUCHE COM COLUNA | MEZCLADORES DE DUCHA DE COLUMNA
COLUMN SHOWER MIXERS



PAG 180 A 182



MISTURADORA DE LAVATÓRIO C/ VCC

REF

CROMADO - BRANCO
CROMO - BLANCO
CHROME - WHITE

CROMADO - CORES STANDARD
CROMO - COLORES STANDARD
CHROME - STANDARD COLORS

xx= 00 23 / 47 / 48

Mezcladora de lavabo con VCC
Washbasin mixer with VCC

5L/min

50621022xx

248 €

274 €

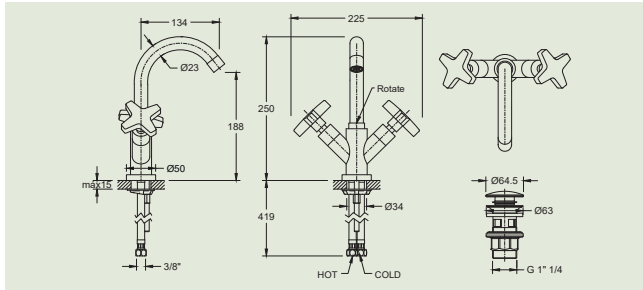

MISTURADORA MURAL DE LAVATÓRIO C/ VCC

REF

CROMADO - BRANCO
CROMO - BLANCO
CHROME - WHITE

CROMADO - CORES STANDARD
CROMO - COLORES STANDARD
CHROME - STANDARD COLORS

xx= 00 23 / 47 / 48

Mezcladora de lavabo de pared con VCC
Wall mounted washbasin mixer with VCC

5L/min

50621222xx

247 €

272 €

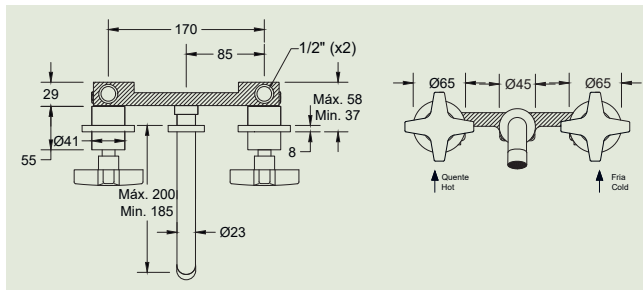

MISTURADORA DE LAVATÓRIO 3 FUROS C/ VCC

REF

CROMADO - BRANCO
CROMO - BLANCO
CHROME - WHITE

CROMADO - CORES STANDARD
CROMO - COLORES STANDARD
CHROME - STANDARD COLORS

xx= 00 23 / 47 / 48

Mezcladora de lavabo 3 agujeros con VCC
3 holes washbasin mixer with VCC

5L/min

50621322xx

511 €

592 €

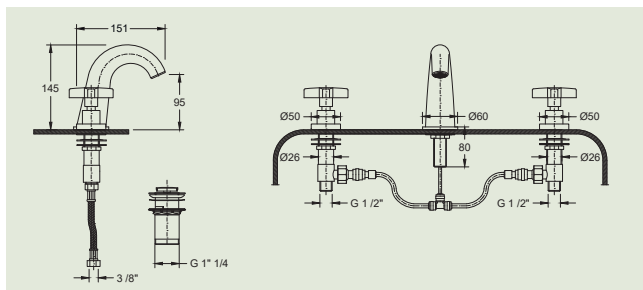

MISTURADORA DE BIDÉ C/ VCC

REF

CROMADO - BRANCO
CROMO - BLANCO
CHROME - WHITE

CROMADO - CORES STANDARD
CROMO - COLORES STANDARD
CHROME - STANDARD COLORS

Mezcladora de bidé con VCC
Bidet mixer with VCC

5L/min



50621042xx

249 €

276 €

xx= 00 23 / 47 / 48

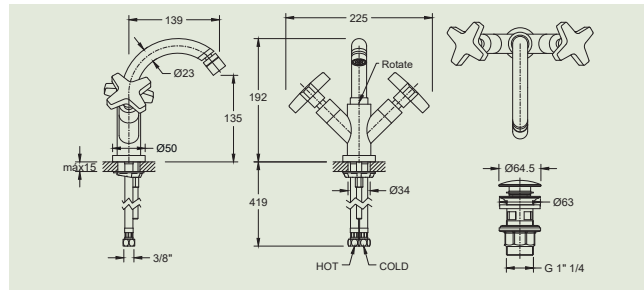

MISTURADORA DE BANHEIRA C/ KIT DE CHUVEIRO

REF

CROMADO - BRANCO
CROMO - BLANCO
CHROME - WHITE

CROMADO - CORES STANDARD
CROMO - COLORES STANDARD
CHROME - STANDARD COLORS

Mezcladora de bañera com kit de ducha
Bath mixer with shower kit

6L/min



50621052xx

277 €

303 €

xx= 00 23 / 47 / 48

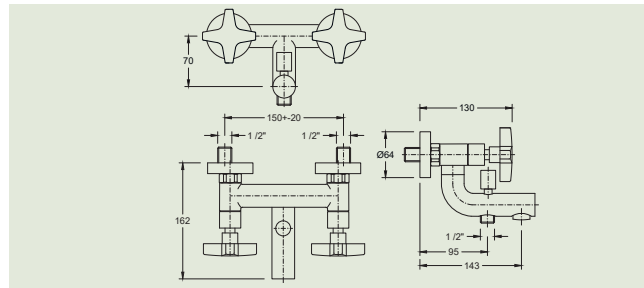

MISTURADORA DE CHÃO DE BANHEIRA C/ KIT DE CHUVEIRO MANUAL

REF

CROMADO - BRANCO
CROMO - BLANCO
CHROME - WHITE

CROMADO - CORES STANDARD
CROMO - COLORES STANDARD
CHROME - STANDARD COLORS

Mezcladora de suelo de baño c/ kit de ducha manual
Floor bath mixer with shower kit

6L/min



50621152xx

806 €

833 €

xx= 00 23 / 47 / 48

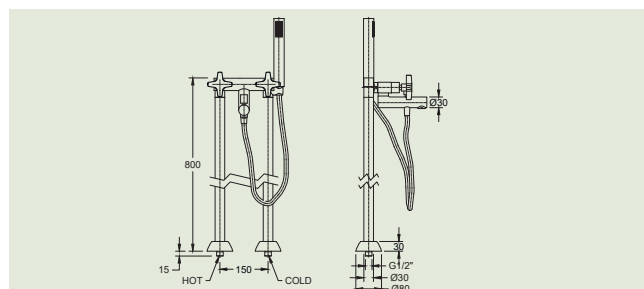

MISTURADORA DE DUCHE C/ KIT DE CHUVEIRO

REF

CROMADO - BRANCO
CROMO - BLANCO
CHROME - WHITE

CROMADO - CORES STANDARD
CROMO - COLORES STANDARD
CHROME - STANDARD COLORS

Mezcladora de ducha con kit de ducha
Shower mixer with shower kit

6L/min

50621062xx

XX= 00 23 / 47 / 48

221 € 243 €

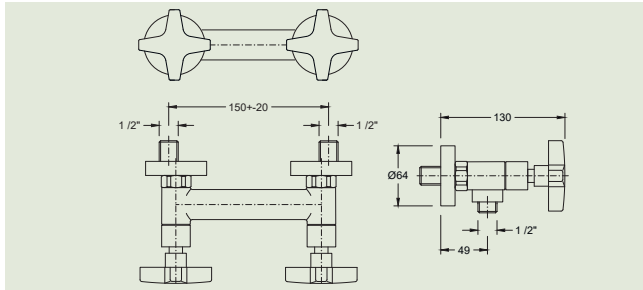

MISTURADORA DE DUCHE 1 SAÍDA

REF

CROMADO - BRANCO
CROMO - BLANCO
CHROME - WHITE

CROMADO - CORES STANDARD
CROMO - COLORES STANDARD
CHROME - STANDARD COLORS

Mezcladora de ducha 1 salida
Shower mixer with 1 way out

50621072xx

XX= 00 23 / 47 / 48

197 € 217 €

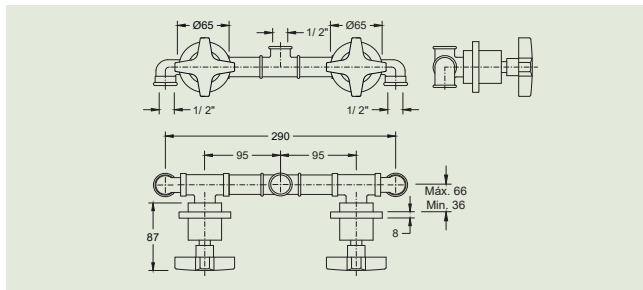

MISTURADORA DE DUCHE C/ INVERSOR ROTATIVO 2 SAÍDAS

REF

CROMADO - BRANCO
CROMO - BLANCO
CHROME - WHITE

CROMADO - CORES STANDARD
CROMO - COLORES STANDARD
CHROME - STANDARD COLORS

Mezcladora de ducha con inversor 2 salidas
Shower mixer with 2 ways diverter

50621272xx

XX= 00 23 / 47 / 48

287 € 314 €

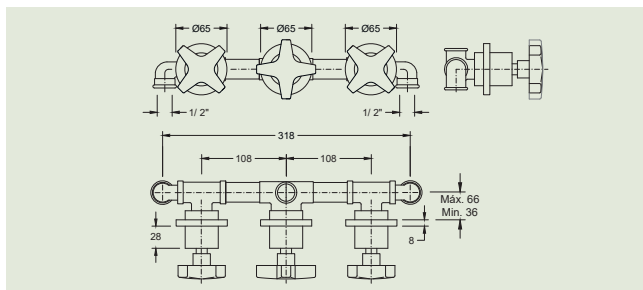

**MISTURADORA DE DUCHE C/
INVERSOR ROTATIVO 3 SAÍDAS**

REF

CROMADO - BRANCO
CROMO - BLANCO
CHROME - WHITE

CROMADO - CORES STANDARD
CROMO - COLORES STANDARD
CHROME - STANDARD COLORS

Mezcladora de ducha con
inversor 3 salidas
Shower mixer with 3 ways diverter

50621372xx

xx= 00 23 / 47 / 48

329 € 370 €

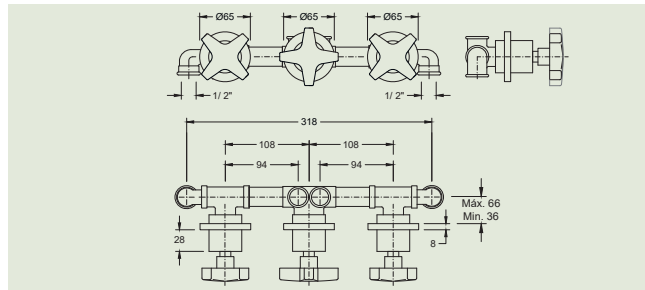

**MISTURADORA DE DUCHE C/ COLUNA
EXTENSÍVEL E CHUVEIRO CAIRO 200MM**

REF

CROMADO - BRANCO
CROMO - BLANCO
CHROME - WHITE

CROMADO - CORES STANDARD
CROMO - COLORES STANDARD
CHROME - STANDARD COLORS

Mezclador de ducha con columna extensi-
ble y ducha Cairo 200mm
Shower mixer with extendable column
and Cairo 200mm shower

50621472xx

xx= 00 23 / 47 / 48

544 € 572 €

6L/min 10L/min

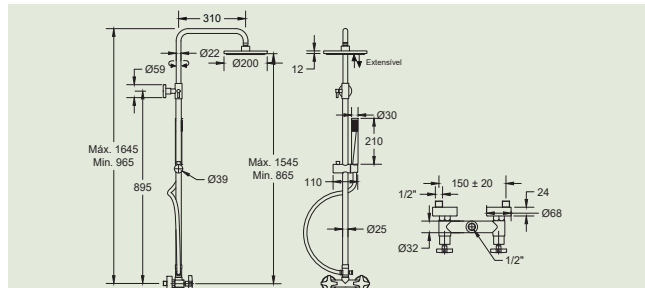

VCC C/ TAMPA CERÂMICA

REF

CROMADO - BRANCO
CROMO - BLANCO
CHROME - WHITE

CROMADO - CORES STANDARD
CROMO - COLORES STANDARD
CHROME - STANDARD COLORS

VCC con tapa cerâmica
VCC with ceramic cover

55110022xx

xx= 00 23 / 47 / 48

59 € 78 €

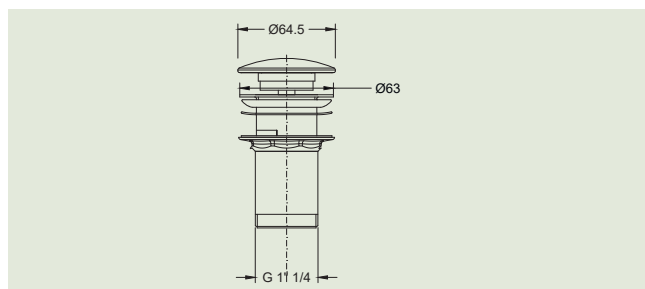

TORNEIRA DE ESQUADRIA 1/2"x3/8"

REF

CROMADO - BRANCO
CROMO - BLANCO
CHROME - WHITE

CROMADO - CORES STANDARD
CROMO - COLORES STANDARD
CHROME - STANDARD COLORS

Grifo de escuadra 1/2 "x3/8"
Cutting tap 1/2 "x3/8"

50621192xx

xx= 00 23 / 47 / 48

53 €

65 €

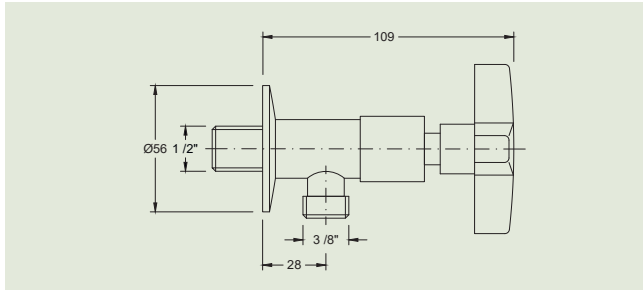

TORNEIRA DE ESQUADRIA 1/2"x1/2"

REF

CROMADO - BRANCO
CROMO - BLANCO
CHROME - WHITE

CROMADO - CORES STANDARD
CROMO - COLORES STANDARD
CHROME - STANDARD COLORS

Grifo de escuadra 1/2 "x1/2"
Cutting tap 1/2 "x1/2"

50621292xx

xx= 00 23 / 47 / 48

53 €

65 €

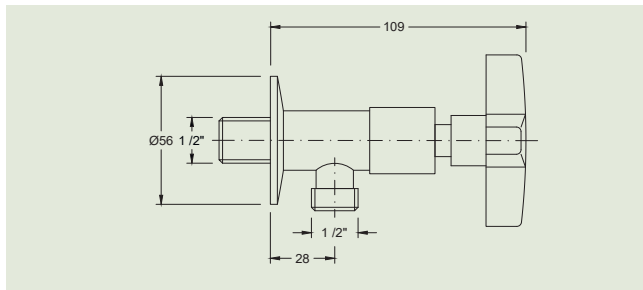

TORNEIRA DE PASSAGEM DE ENCASTRAR 1/2"

REF

CROMADO - BRANCO
CROMO - BLANCO
CHROME - WHITE

CROMADO - CORES STANDARD
CROMO - COLORES STANDARD
CHROME - STANDARD COLORS

Grifo de corte empotrado de 1/2 "
Wall mounted cutting tap 1/2"

50621392xx

xx= 00 23 / 47 / 48

54 €

68 €

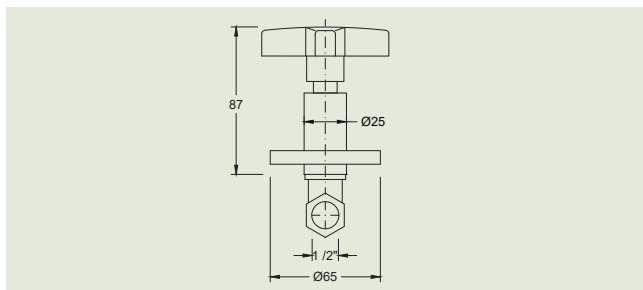

TORNEIRA DE PASSAGEM DE ENCASTRAR 3/4"

REF

CROMADO - BRANCO
CROMO - BLANCO
CHROME - WHITECROMADO - CORES STANDARD
CROMO - COLORES STANDARD
CHROME - STANDARD COLORSGrifo de corte empotrado de 3/4"
Wall mounted cutting tap 3/4"

XX= 00 23 / 47 / 48

50621492xx

60 €

74 €

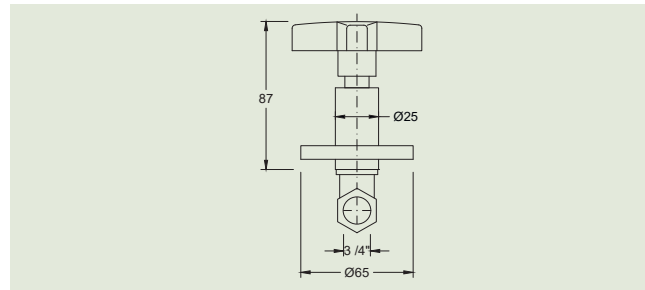
**MISTURADORA DE COZINHA C/ BICA ROTATIVA**

REF

CROMADO - BRANCO
CROMO - BLANCO
CHROME - WHITECROMADO - CORES STANDARD
CROMO - COLORES STANDARD
CHROME - STANDARD COLORSMezcladora de cocina con cãno giratorio
Kitchen mixer with rotating spout

XX= 00 23 / 47 / 48

6L/min

50621482xx

298 €

326 €

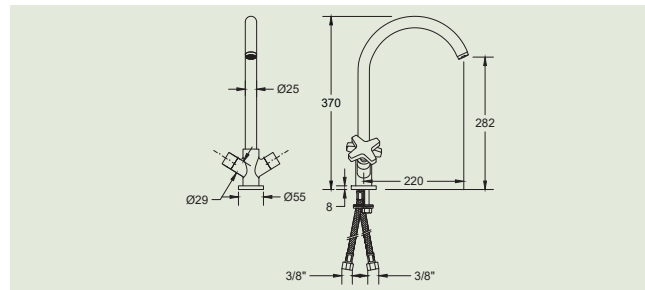
**TOMADA DE ÁGUA C/ SUPORTE PARA CHUVEIRO DE MÃO**

REF

CROMADO
CROMO
CHROMEConexión de agua con soporte de ducha de mano
Water outlet w/ hand shower support

55173022

34 €

HASTE DE PAREDE 35CM

REF

CROMADO
CROMO
CHROMEBarra mural para ducha 35cm
Wall rod 35cm

50697232

42 €

HASTE DE TECTO 15CM

REF

CROMADO
CROMO
CHROMEBarra de tecto 15cm
Ceilling rod 15cm

50697242

30 €

CHUVEIRO DE MÃO (8 L/MIN.)

REF

CROMADO
CROMO
CHROMEDucha de mano (8 L/min.)
Hand shower (8 L/min.)

50697062

22 €

**CHUVEIRO DE TECTO 20CM
REDONDO EM LATÃO (10 L/MIN.)**

REF

CROMADO
CROMO
CHROMEDucha de techo en laton 20cm redondo
(10 L/min.)
Brass head shower 20cm (10 L/min.)

50683112

119 €

FLEXÍVEL DUPLA GRAFATURA 150CM

REF

CROMADO
CROMO
CHROMEManguera de ducha de mano 150cm
Shower flexible hose 150cm

50617022

14 €

FLEXÍVEL PVC ANTI TORSÃO 150CM

REF

CROMADO
CROMO
CHROMEManguera de ducha PVC anti torsión
150cm
PVC anti torsion shower flexible hose
150cm

50617042

18 €

SIFÃO CILÍNDRICO

REF

CROMADO
CROMO
CHROMESifón cilíndrico
Cilindric siphon

55109132

45 €

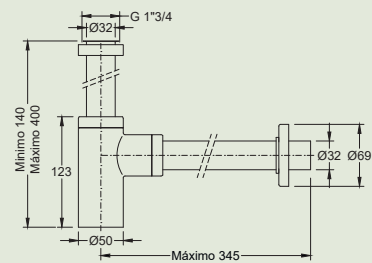

MISTURADORA DE LAVATÓRIO C/ VCC	REF	CROMADO CROMO CHROME	PRETO MATE NEGRO MATE MATT BLACK
		X = 2	X = 3

Mezcladora de lavabo c / VCC
Washbasin mixer with VCC

5066202x

194 €

276 €

5L/min

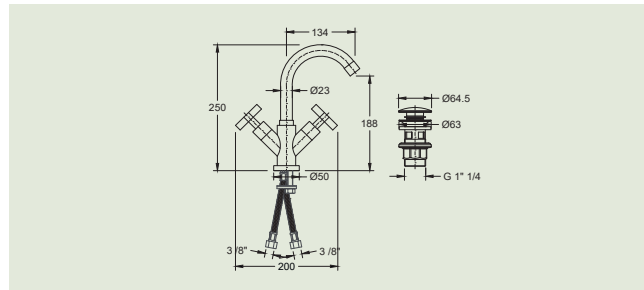

MISTURADORA DE LAVATÓRIO MURAL C/ VCC	REF	CROMADO CROMO CHROME	PRETO MATE NEGRO MATE MATT BLACK
		X = 2	X = 3

Mezcladora de lavabo mural c / VCC
Wall mounted washbasin mixer with VCC

5066222x

251 €

377 €

5L/min

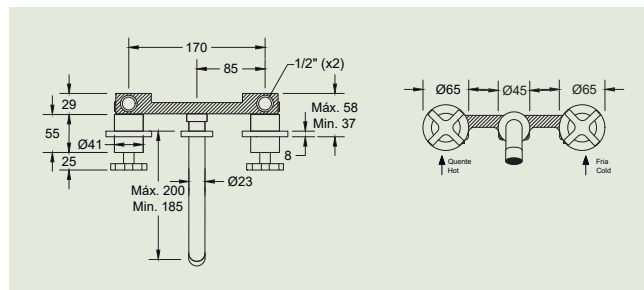

MISTURADORA DE LAVATÓRIO 3 FUROS C/ VCC	REF	CROMADO CROMO CHROME	PRETO MATE NEGRO MATE MATT BLACK
		X = 2	X = 3

Mezcladora de lavabo 3 agujeros c / VCC
3 holes washbasin mixer with VCC

5066232x

240 €

359 €

5L/min

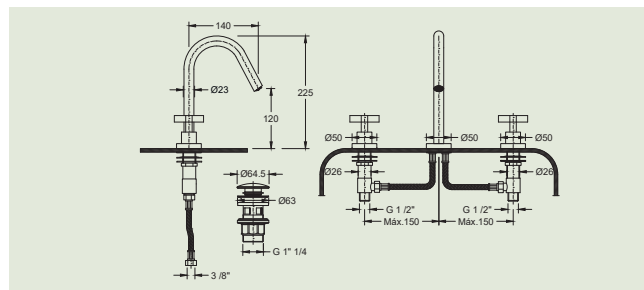

MISTURADORA BIDÉ C/ VCC

REF

CROMADO
CROMO
CHROME

PRETO MATE
NEGRO MATE
MATT BLACK

X = 2

X = 3

Mezcladora de bidé c/ VCC
Bidet mixer with VCC

5L/min

5066204x

194 €

276 €

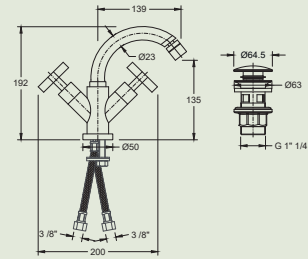

MISTURADORA DE BANHEIRA C/ KIT DE CHUVEIRO MANUAL

REF

CROMADO
CROMO
CHROME

PRETO MATE
NEGRO MATE
MATT BLACK

X = 2

X = 3

Mezcladora de bañera c/ kit de ducha manual
Bath mixer with shower kit

6L/min

5066205x

275 €

413 €

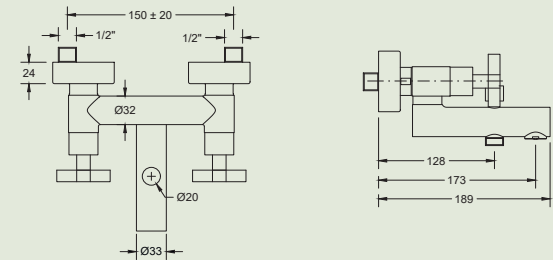

MISTURADORA DE CHÃO DE BANHEIRA C/ KIT DE CHUVEIRO MANUAL

REF

CROMADO
CROMO
CHROME

PRETO MATE
NEGRO MATE
MATT BLACK

X = 2

X = 3

Mezcladora de suelo de baño c/ kit de ducha manual
Floor bath mixer with shower kit

6L/min

5066225x

730 €

1.095 €

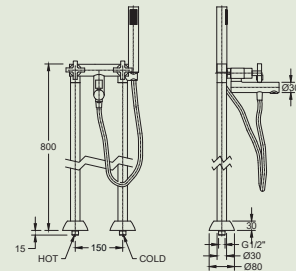

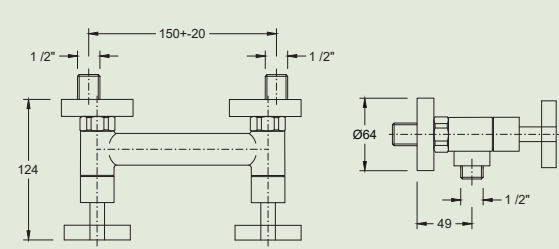
MISTURADORA DE DUCHE C/ KIT DE CHUVEIRO MANUAL		REF	CROMADO CROMO CHROME	PRETO MATE NEGRO MATE MATT BLACK
Mezcladora de ducha con kit de ducha manual Shower mixer with shower kit		5066206x	X = 2	X = 3
6L/min		204 €	305 €	
				

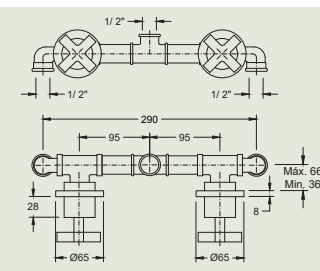
MONOCOMANDO DUCHE MURAL		REF	CROMADO CROMO CHROME	PRETO MATE NEGRO MATE MATT BLACK
Monocomando ducha mural Wall mounted single lever shower mixer		5066207x	X = 2	X = 3
		202 €	262 €	
				

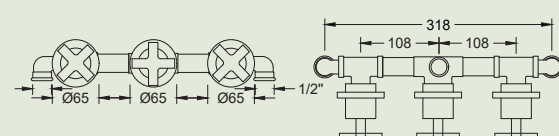
MISTURADORA DUCHE MURAL 2 VIAS		REF	CROMADO CROMO CHROME	PRETO MATE NEGRO MATE MATT BLACK
Mezcladora ducha mural 2 vías Wall mounted shower mixer with 2 ways diverter		5066277x	X = 2	X = 3
		288 €	432 €	
				



MISTURADORA DUCHE MURAL 3 VIAS

REF

CROMADO
CROMO
CHROME

PRETO MATE
NEGRO MATE
MATT BLACK

Mezcladora ducha mural 3 vías
Wall mounted shower mixer with 3 ways diverter

X = 2

X = 3

5066257x

328 €

492 €

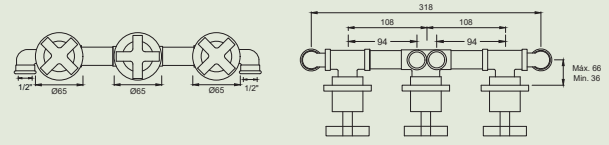

MISTURADORA DUCHE C/COLUNA TELESCÓPICA E CHUV. CAIRO 200MM

REF

CROMADO
CROMO
CHROME

PRETO MATE
NEGRO MATE
MATT BLACK

Mezcladora de ducha con columna telescópica y ducha Cairo 200mm
Shower mixer with telescopic column and head shower Cairo 200mm

X = 2

X = 3

5066247x

440 €

659 €

6L/min 10L/min

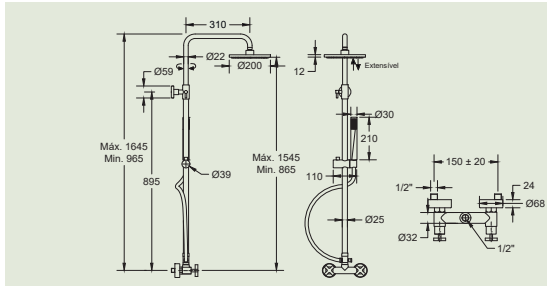

TOMADA DE ÁGUA C/ SUPORTE

REF

CROMADO
CROMO
CHROME

PRETO MATE
NEGRO MATE
MATT BLACK

Conexión de agua con soporte
Wall mounted water outlet with hand shower support

X = 2

X = 3

5517302x

34 €

51 €

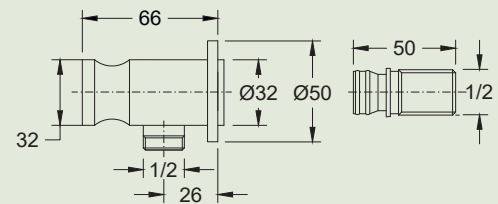

**HASTE DE PAREDE 35CM**

REF

CROMADO
CROMO
CHROMEPRETO MATE
NEGRO MATE
MATT BLACKBarra mural para ducha 35cm
Wall rod 35cm

5069723x

X = 2

X = 3

42 €

63 €

HASTE DE TECTO 15CM

REF

CROMADO
CROMO
CHROMEPRETO MATE
NEGRO MATE
MATT BLACKBarra de techo 15cm
Ceilling rod 15cm

5069724x

X = 2

X = 3

30 €

46 €

CHUVEIRO DE MÃO (8 L/MIN.)

REF

CROMADO
CROMO
CHROMEPRETO MATE
NEGRO MATE
MATT BLACKDucha de mano (8 L/min.)
Hand shower (8 L/min.)

5069706x

X = 2

X = 3

22 €

55 €

CHUVEIRO DE TECTO 20CM REDONDO EM LATÃO (8 L/MIN.)

REF

CROMADO
CROMO
CHROMEPRETO MATE
NEGRO MATE
MATT BLACKDucha de techo en laton 20cm redondo
(8 L/min.)
Brass head shower 20cm (8 L/min.)

5068311x

X = 2

X = 3

119 €

159 €

FLEXÍVEL DUPLA GRAFATURA 150CM

REF

CROMADO
CROMO
CHROMEManguera de ducha de mano 150cm
Shower flexible hose 150cm

5061702x

X = 2

14 €

FLEXÍVEL PVC ANTI TORSÃO 150CM

REF

CROMADO
CROMO
CHROMEPRETO MATE
NEGRO MATE
MATT BLACKManguera de ducha PVC
anti torsión 150cm
PVC anti torsion shower
flexible hose 150cm

5061704x

X = 2

X = 3

18 €

26 €

TORNEIRA DE ESQUADRIA 1/2" x 3/8"

REF

CROMADO
CROMO
CHROME

PRETO MATE
NEGRO MATE
MATT BLACK

X = 2

X = 3

Grifo de escuadra de 1/2"x3/8"
Cutting tap 1/2"x3/8"

5066219x

45 €

68 €

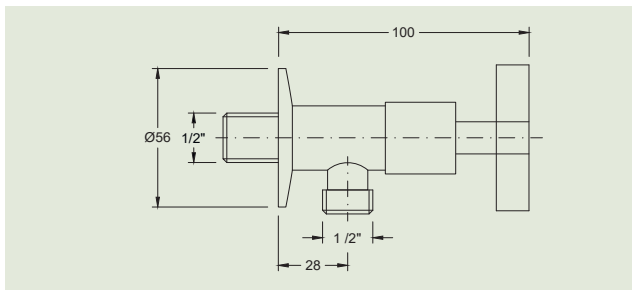

TORNEIRA DE ESQUADRIA 1/2" x 1/2"

REF

CROMADO
CROMO
CHROME

PRETO MATE
NEGRO MATE
MATT BLACK

X = 2

X = 3

Grifo de escuadra de 1/2"x1/2"
Cutting tap 1/2"x1/2"

5066229x

48 €

124 €

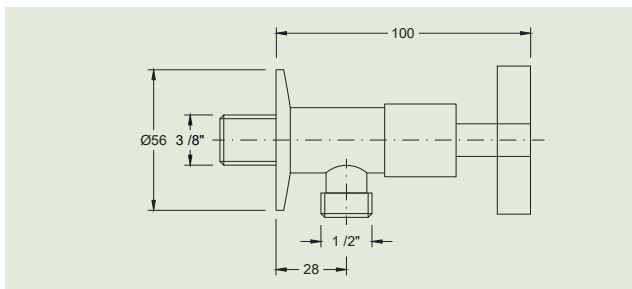

TORNEIRA DE PASSAGEM DE 1/2"

REF

CROMADO
CROMO
CHROME

PRETO MATE
NEGRO MATE
MATT BLACK

X = 2

X = 3

Grifo de corte empotrado de 1/2"
Wall mounted cutting tap 1/2"

5066239x

55 €

71 €

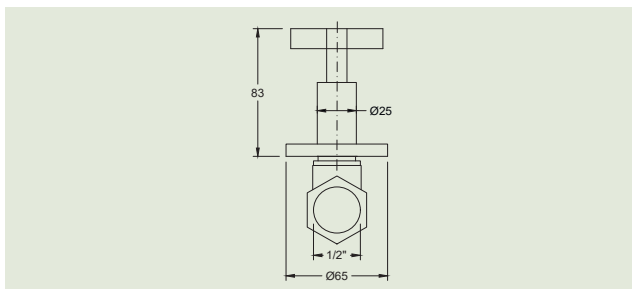

TORNEIRA DE PASSAGEM DE 3/4"

REF

CROMADO
CROMO
CHROMEPRETO MATE
NEGRO MATE
MATT BLACKGrifo de corte empotrado de 3/4"
Wall mounted cutting tap 3/4"

5066249x

X = 2

X = 3

57 €

78 €

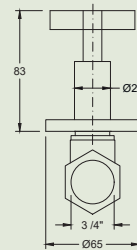
MISTURADORA DE COZINHA
C/ BICA ROTATIVA

REF

CROMADO
CROMO
CHROMEPRETO MATE
NEGRO MATE
MATT BLACKMezclador de cocina con caño giratorio
Kitchen mixer with rotating spout

6L/min

5066258x

X = 2

X = 3

262 €

393 €

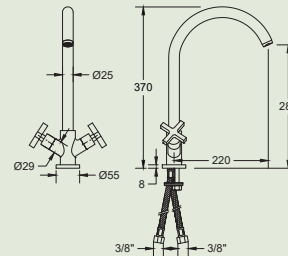

SIFÃO CILÍNDRICO

REF

CROMADO
CROMO
CHROMEPRETO MATE
NEGRO MATE
MATT BLACKSifón cilíndrico
Cilindric siphon

5510913x

X = 2

X = 3

45 €

68 €

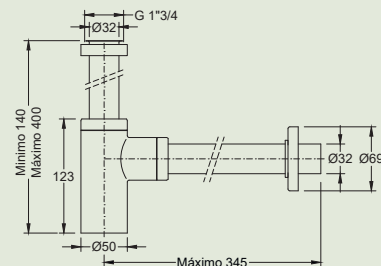

VÁLVULA CLIC-CLAC

REF

CROMADO
CROMO
CHROMEPRETO MATE
NEGRO MATE
MATT BLACKVálvula clic-clac
Pop-up waste

5511002x

X = 2

X = 3

20 €

28 €

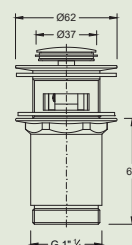

MONOCOMANDO DE LAVATÓRIO C/ VCC

REF

CROMADO CROMO CHROME

PRETO MATE NEGRO MATE BLACK MATT

DOURADO MATE ORO MATE GOLD MATT

X = 2

X = 3

X = 5

Monocomando de lavabo c/ VCC
Single lever washbasin mixer w/ VCC

5069502x

182 €

261 €

261 €

5L/min

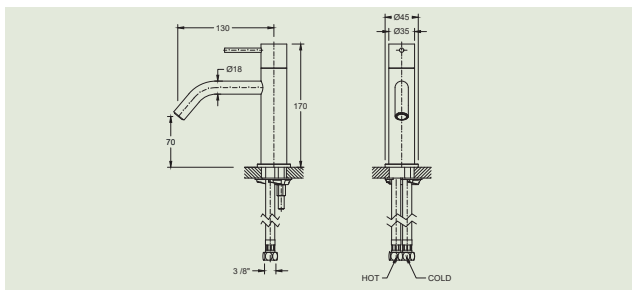

MONOCOMANDO DE LAVATÓRIO ALTO C/ VCC

REF

CROMADO CROMO CHROME

PRETO MATE NEGRO MATE BLACK MATT

DOURADO MATE ORO MATE GOLD MATT

X = 2

X = 3

X = 5

Monocomando de lavabo alto c/ VCC
Bowl mixer w/ VCC

5069512x

238 €

341 €

341 €

5L/min

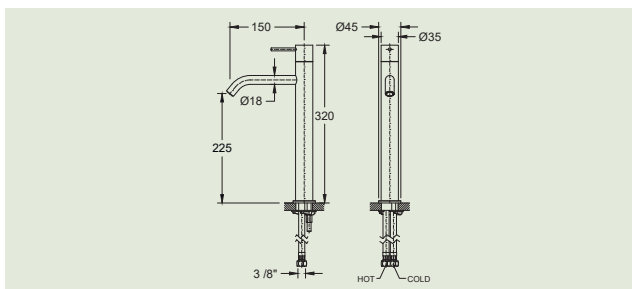

MONOCOMANDO DE LAVATÓRIO MURAL C/ VCC

REF

CROMADO CROMO CHROME

PRETO MATE NEGRO MATE BLACK MATT

DOURADO MATE ORO MATE GOLD MATT

X = 2

X = 3

X = 5

Monocomando lavabo mural c/ VCC
Wall mounted washbasin mixer w/ VCC

5069582xC

342 €

416 €

416 €

5L/min

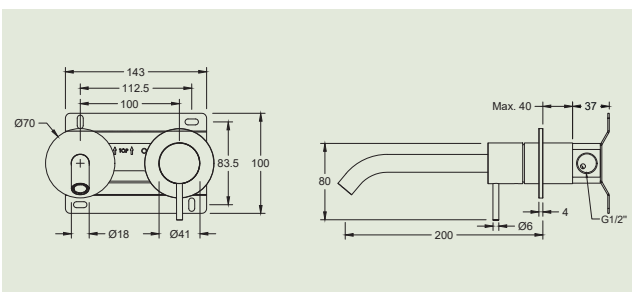

MONOCOMANDO LAVATÓRIO DE BANCADA 2 FUROS C/ VCC

REF

CROMADO CROMO CHROME

PRETO MATE NEGRO MATE BLACK MATT

DOURADO MATE ORO MATE GOLD MATT

Monocomando de lavabo de encimera
2 orifícios c/ VCC
Single lever top washbasin mixer
2 holes w/ VCC

5069542x

X = 2

X = 3

X = 5

373 €

532 €

532 €

5L/min

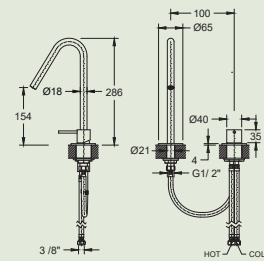

MONOCOMANDO DE BIDÉ C/ VCC

REF

CROMADO CROMO CHROME

PRETO MATE NEGRO MATE BLACK MATT

DOURADO MATE ORO MATE GOLD MATT

Monocomando de bidé c/ VCC
Single lever bidet mixer w/ VCC

5069504x

X = 2

X = 3

X = 5

182 €

261 €

261 €

5L/min

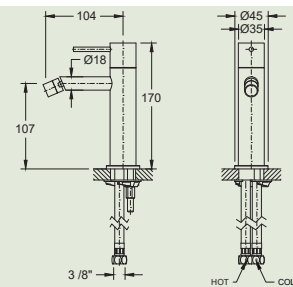

MONOCOMANDO BANHEIRA

REF

CROMADO CROMO CHROME

PRETO MATE NEGRO MATE BLACK MATT

DOURADO MATE ORO MATE GOLD MATT

Monocomando de banheira
Single lever bath mixer

5069505x

X = 2

X = 3

X = 5

364 €

520 €

520 €

6L/min

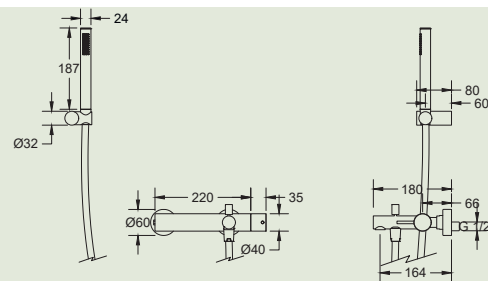

MONOCOMANDO DE CHÃO P/ BANHEIRA C/ KIT DE DUCHE

REF

CROMADO CROMO CHROME

PRETO MATE NEGRO MATE BLACK MATT

DOURADO MATE ORO MATE GOLD MATT

Monocomando de suelo para bañera c/ kit de ducha
Floor bath mixer w/ shower kit

5069525xC

X = 2

X = 3

X = 5

1.295 €

1.760 €

1.760 €

6L/min

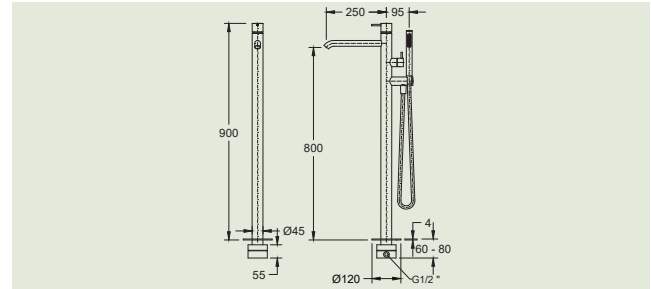

MONOCOMANDO DE DUCHE C/ KIT DE CHUVEIRO

REF

CROMADO CROMO CHROME

PRETO MATE NEGRO MATE BLACK MATT

DOURADO MATE ORO MATE GOLD MATT

Monocomando de ducha con kit de ducha
Single lever shower mixer with shower kit

5069506x

X = 2

X = 3

X = 5

266 €

380 €

380 €

6L/min

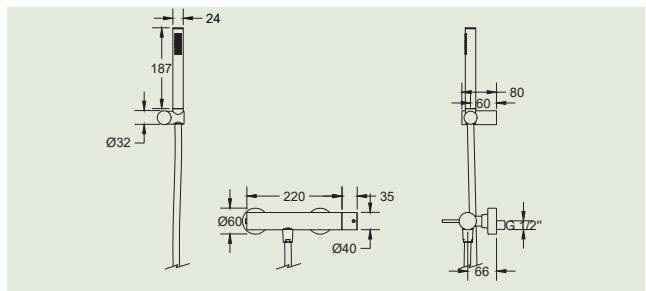

MONOCOMANDO DE DUCHE 1 VIA

REF

CROMADO CROMO CHROME

PRETO MATE NEGRO MATE BLACK MATT

DOURADO MATE ORO MATE GOLD MATT

Monocomando de ducha 1 via
Shower mixer 1 way

5069567xC

X = 2

X = 3

X = 5

163 €

182 €

182 €

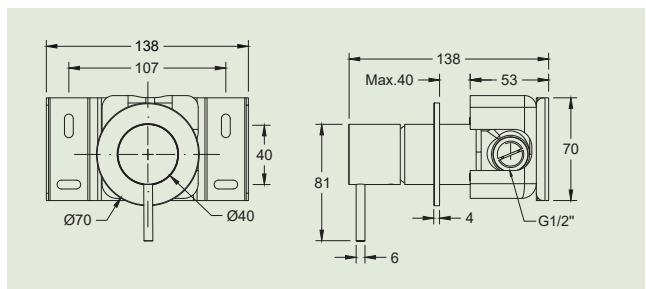

**MONOCOMANDO DE DUCHE 2 VIAS
C/ KIT DE CHUVEIRO**

REF

CROMADO
CROMO
CHROME

PRETO MATE
NEGRO MATE
BLACK MATT

DOURADO MATE
ORO MATE
GOLD MATT

Monocomando de ducha 2 vias c/ kit de ducha
Shower mixer 2 ways w/ shower kit

 6L/min

5069557xC

X = 2

X = 3

X = 5

493 €

606 €

606 €

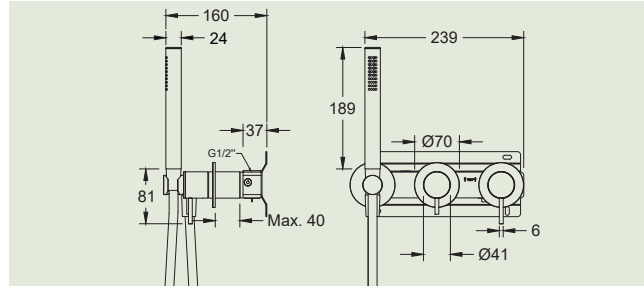

**MONOCOMANDO DE DUCHE 3 VIAS
C/ KIT DE CHUVEIRO**

REF

CROMADO
CROMO
CHROME

PRETO MATE
NEGRO MATE
BLACK MATT

DOURADO MATE
ORO MATE
GOLD MATT

Monocomando de ducha 3 vias c/ kit de ducha
Shower mixer 3 ways w/ hand shower kit

 6L/min

5069577xC

X = 2

X = 3

X = 5

504 €

617 €

617 €

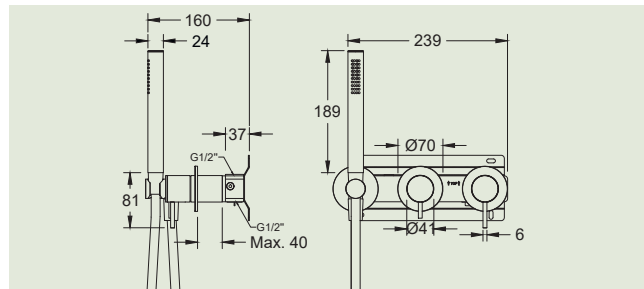

BICA DE BANHEIRA DE ENCASTRAR

REF

CROMADO
CROMO
CHROME

PRETO MATE
NEGRO MATE
BLACK MATT

DOURADO MATE
ORO MATE
GOLD MATT

Bica de banheira empotrable
Wall mounted bath spout

5069555x

X = 2

X = 3

X = 5

121 €

173 €

173 €

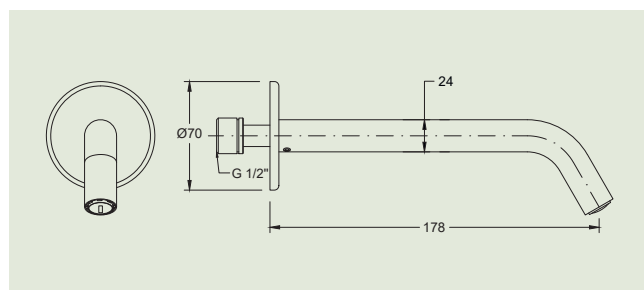

MONOCOMANDO C/ KIT HIGIÉNICO

REF

CROMADO CROMO CHROME

PRETO MATE NEGRO MATE BLACK MATT

DOURADO MATE ORO MATE GOLD MATT

X = 2

X = 3

X = 5

Monocomando c/ kit de aseo
Wall mounted w/ hygienic kit

5069514xC

286 €

408 €

408 €

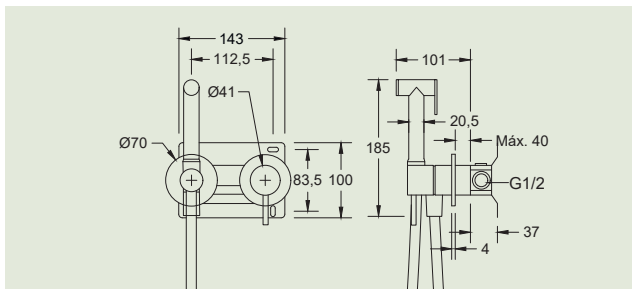

TOMADA DE ÁGUA C/ KIT DE CHUVEIRO DE MÃO

REF

CROMADO CROMO CHROME

PRETO MATE NEGRO MATE BLACK MATT

DOURADO MATE ORO MATE GOLD MATT

X = 2

X = 3

X = 5

Conexión de agua con kit de ducha de mano
Wall mounted water outlet connector w/ hand shower kit

5069547x

191 €

272 €

272 €

6L/min

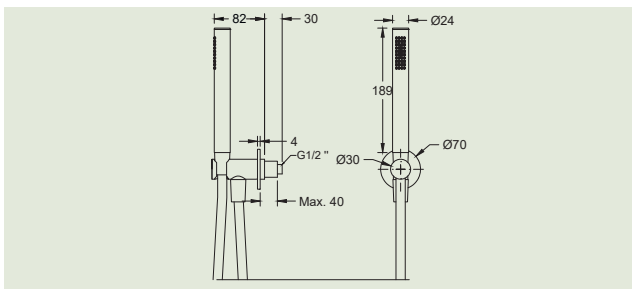

MONOCOMANDO DE COZINHA C/ BICA ROTATIVA E CHUVEIRO EXTENSÍVEL

REF

CROMADO CROMO CHROME

PRETO MATE NEGRO MATE BLACK MATT

DOURADO MATE ORO MATE GOLD MATT

X = 2

X = 3

X = 5

Monocomando de cocina con caño giratorio e ducha extensible
Kitchen mixer with rotating spout and extendable shower

5069558x

190 €

285 €

285 €

6L/min

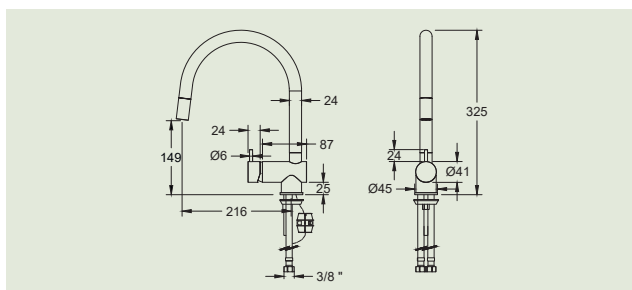

SIFÃO CILÍNDRICO

REF

CROMADO
CROMO
CHROMEPRETO MATE
NEGRO MATE
BLACK MATTDOURADO MATE
ORO MATE
GOLD MATTSifón cilíndrico
Cilindric siphon

5510915x

X = 2

X = 3

X = 5

63 €

100 €

100 €

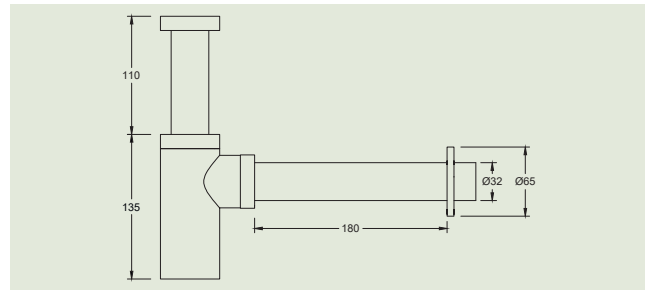

CHUVEIRO DE TECTO 200MM

REF

CROMADO
CROMO
CHROMEPRETO MATE
NEGRO MATE
BLACK MATTDOURADO MATE
ORO MATE
GOLD MATTDucha de techo 200mm
Head shower 200mm

5068321x

X = 2

X = 3

X = 5

219 €

313 €

313 €

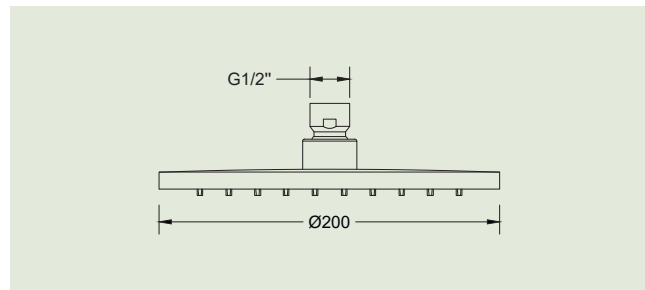

HASTE DE TECTO 170MM

REF

CROMADO
CROMO
CHROMEPRETO MATE
NEGRO MATE
BLACK MATTDOURADO MATE
ORO MATE
GOLD MATTBarra de techo 170mm
Ceiling rod 170mm

5069721x

X = 2

X = 3

X = 5

31 €

61 €

61 €

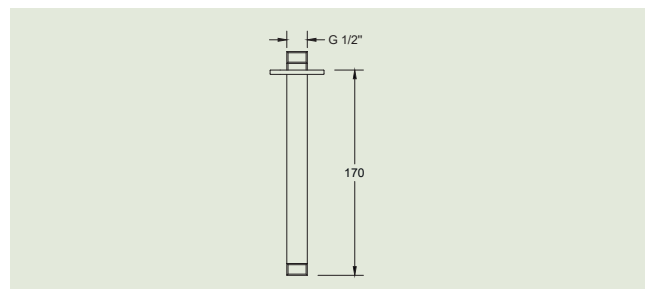

HASTE DE PAREDE 350MM

REF

CROMADO
CROMO
CHROMEPRETO MATE
NEGRO MATE
BLACK MATTDOURADO MATE
ORO MATE
GOLD MATTBarra mural 350mm
Wall rod 350mm

5069743x

X = 2

X = 3

X = 5

93 €

132 €

132 €

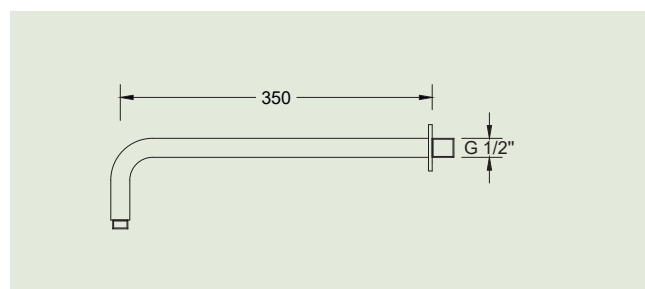

MONOCOMANDO DE LAVATÓRIO C/ VCC

REF

CROMADO
CROMO
CHROME

PRETO MATE
NEGRO MATE
BLACK MATT

Monocomando de lavabo c / VCC
Single lever washbasin mixer with VCC

5061302x

X = 2

X = 3

237 €

356 €

5L/min

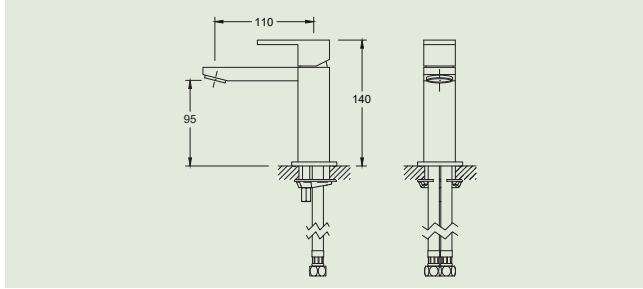

MONOCOMANDO DE LAVATÓRIO MURAL ESPELHOS QUADRADOS C/ VCC

REF

CROMADO
CROMO
CHROME

PRETO MATE
NEGRO MATE
BLACK MATT

Monocomando de lavabo mural 2 espejos cuadrados c / VCC
Single lever wall mounted basin mixer with 2 square mirrors and VCC

5061332x

X = 2

X = 3

371 €

558 €

5L/min

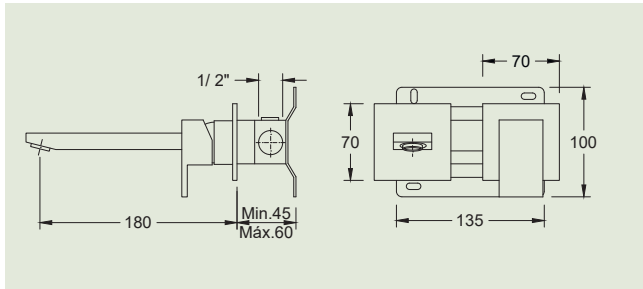

MONOCOMANDO DE BIDÉ C/ VCC

REF

CROMADO
CROMO
CHROME

PRETO MATE
NEGRO MATE
BLACK MATT

Monocomando de bidé c / VCC
Single lever bidet mixer with VCC

5061304x

X = 2

X = 3

237 €

356 €

5L/min

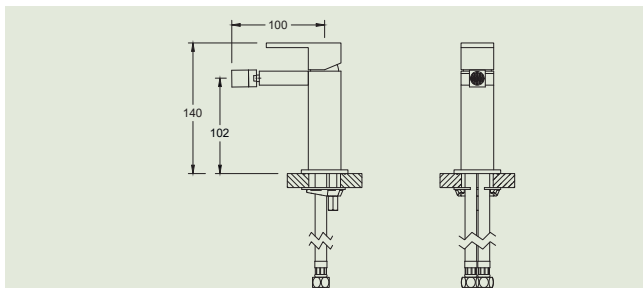

MONOCOMANDO DE LAVATÓRIO ALTO 120 C/ VCC

REF

CROMADO
CROMO
CHROME

PRETO MATE
NEGRO MATE
BLACK MATT

Monocomando de lavabo alto 120 c / VCC
Single lever bowl mixer 120 with VCC

5061312x

X = 2

X = 3

322 €

485 €

5L/min

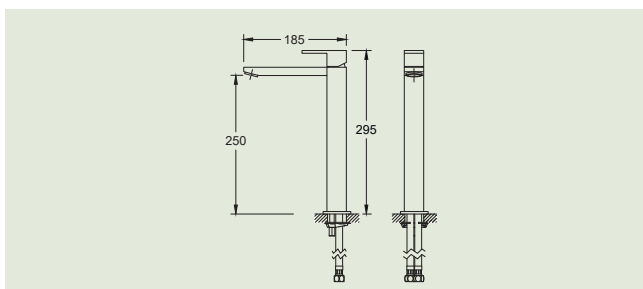

MONOCOMANDO DE BANHEIRA C/ KIT DE CHUVEIRO MANUAL

REF

CROMADO CROMO CHROME

PRETO MATE NEGRO MATE BLACK MATT

Monocomando de bañeira c/ kit de ducha manual
Single lever bath mixer with shower kit

5061305x

X = 2

X = 3

385 €

577 €

 6L/min

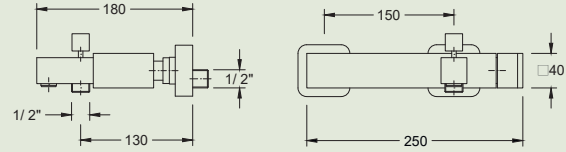

MONOCOMANDO DE BASE DE DUCHE C/ KIT DE CHUVEIRO MANUAL

REF

CROMADO CROMO CHROME

PRETO MATE NEGRO MATE BLACK MATT

Monocomando de ducha con kit de ducha manual
Single lever shower mixer with shower kit

5061306x

X = 2

X = 3

351 €

527 €

 6L/min

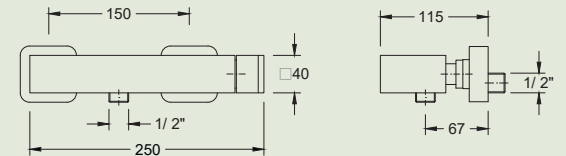

MONOCOMANDO DUCHE MURAL

REF

CROMADO CROMO CHROME

PRETO MATE NEGRO MATE BLACK MATT

Monocomando ducha mural
Wall mounted single lever shower mixer

5061307x

X = 2

X = 3

206 €

309 €

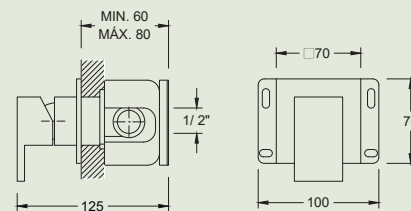

**MONOCOMANDO BANHO/
DUCHE MURAL**

REF

CROMADO
CROMO
CHROME

PRETO MATE
NEGRO MATE
BLACK MATT

X = 2

X = 3

Monocomando baño / ducha mural
Wall mounted single lever bath/shower
mixer

5061317x

287 €

429 €

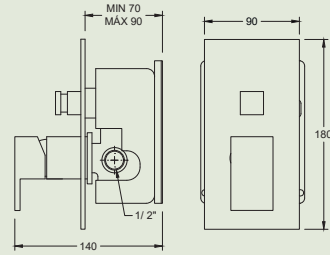

**MONOCOMANDO DE DUCHE 2 VIAS
DE EMBUTIR C/ KIT DE CHUVEIRO**

REF

CROMADO
CROMO
CHROME

PRETO MATE
NEGRO MATE
BLACK MATT

X = 2

X = 3

Monocomando ducha mural 2 vías c /
kit de ducha manual
Wall mounted shower mixer with 2
ways diverter, shower kit

5061327x

473 €

709 €

 6L/min

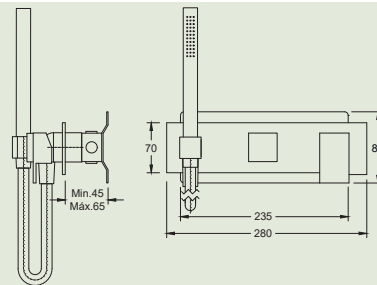

**MONOCOMANDO DE EMBUTIR C/ KIT
HIGIÉNICO**

REF

CROMADO
CROMO
CHROME

PRETO MATE
NEGRO MATE
BLACK MATT

X = 2

X = 3

Monocomando de embutir c / kit
higiénico
Wall mounted single lever mixer with
hygienic kit

5061314x

312 €

467 €

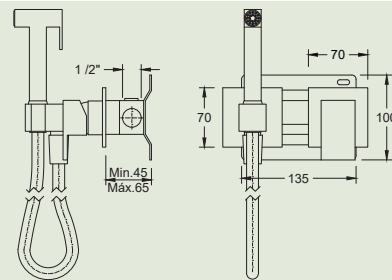

**MONOCOMANDO DE DUCHE C/
COLUNA TELESCÓPICA E CHUVEIRO
QUADRADO DE 200MM**

REF

CROMADO
CROMO
CHROME

PRETO MATE
NEGRO MATE
BLACK MATT

Monocomando de ducha c/ columna telescópica y ducha cuadrado 200mm
Shower mixer with telescopic column and square shower 200mm

5061367x

X = 2

X = 3

1.049 €

1.575 €

 6L/min  10L/min

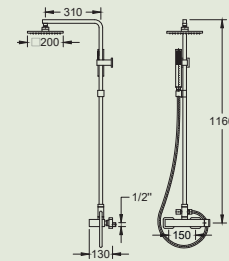

**MONOCOMANDO DE CHÃO P/
BANHEIRA C/ KIT DE DUCHE**

REF

CROMADO
CROMO
CHROME

PRETO MATE
NEGRO MATE
BLACK MATT

Monocomando de suelo para bañeira c/ kit de ducha
Floor bath mixer w/ shower kit

5061315x

X = 2

X = 3

1.620 €

2.187 €

 6L/min

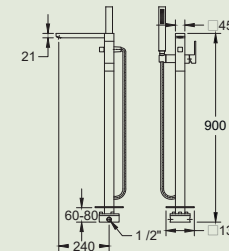

SIFÃO QUADRADO

REF

CROMADO
CROMO
CHROME

PRETO MATE
NEGRO MATE
BLACK MATT

Sifón cuadrado
Square siphon

5510914x

X = 2

X = 3

78 €

158 €

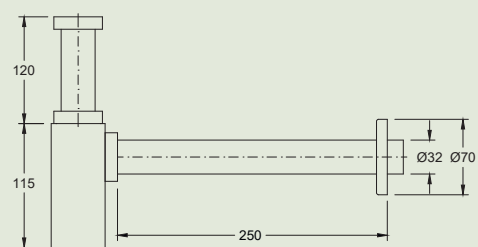

VÁLVULA CLIC-CLAC

REF

CROMADO
CROMO
CHROME

PRETO MATE
NEGRO MATE
BLACK MATT

Válvula clic-clac
Pop-up waste

5511005x

X = 2

X = 3

60 €

87 €

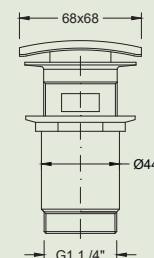

MONOCOMANDO DE DUCHE 3 VIAS DE EMBUTIR C/ KIT DE CHUVEIRO

REF

CROMADO CROMO CHROME

PRETO MATE NEGRO MATE BLACK MATT

X = 2

X = 3

Monocomando ducha mural 3 vías c / kit de ducha manual
Wall mounted shower mixer with 3 ways diverter, shower kit

5061337x

549 €

823 €

6L/min

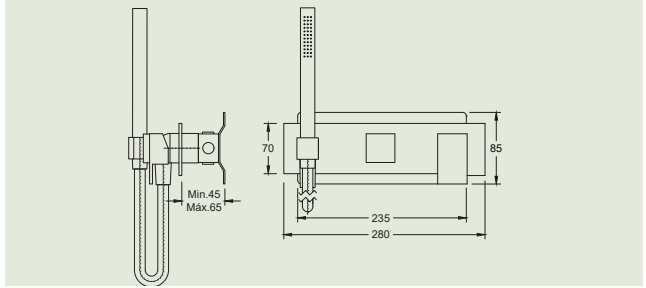

TOMADA DE ÁGUA C/ KIT DE CHUVEIRO DE MÃO

REF

CROMADO CROMO CHROME

PRETO MATE NEGRO MATE BLACK MATT

X = 2

X = 3

Conexión de agua con kit de ducha de mano
Wall mounted water outlet connector with hand shower kit

5061397x

137 €

206 €

6L/min

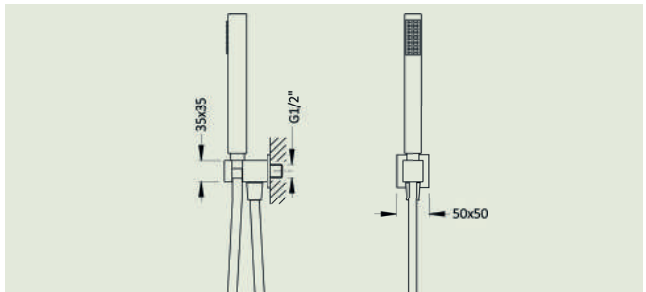

MISTURADORA DE LAVATÓRIO C/ VDA	REF	CROMADO CROMO CHROME	DOURADO DORADO GOLDEN	DOURADO MATE ORO MATE MATT GOLD
		X = 2	X = 4	X = 5

Mezcladora de lavabo c / VDA
Washbasin mixer w/ automatic waste

5063502x

142 €

283 €

283 €

5L/min

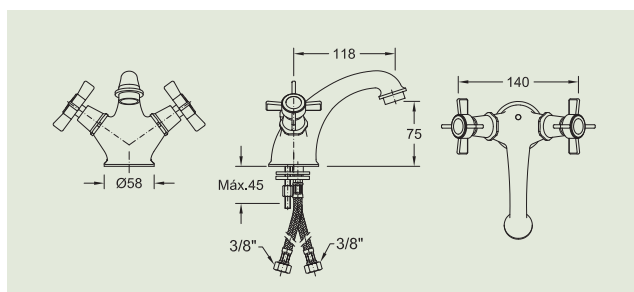

MISTURADORA DE LAVATÓRIO 3 FUROS C/ VDA	REF	CROMADO CROMO CHROME	DOURADO DORADO GOLDEN	DOURADO MATE ORO MATE MATT GOLD
		X = 2	X = 4	X = 5

Mezcladora de lavabo 3 agujeros c / VDA
Three holes washbasin mixer w/ automatic waste

5063531x

269 €

510 €

510 €

5L/min

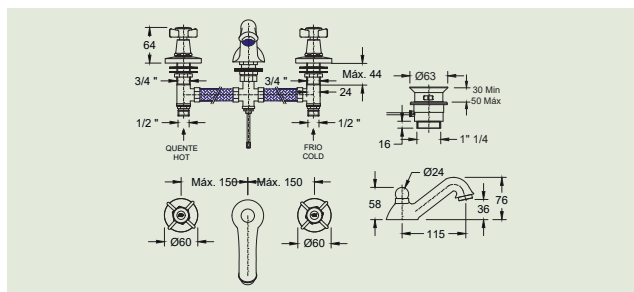

MISTURADORA DE LAVATÓRIO MURAL C/ VÁLVULA CLIC-CLAC	REF	CROMADO CROMO CHROME	DOURADO DORADO GOLDEN	DOURADO MATE ORO MATE MATT GOLD
		X = 2	X = 4	X = 5

Mezcladora de lavabo mural c / válvula clic-clac
Wall mounted washbasin mixer w/ pop-up waste

5063522x

228 €

393 €

393 €

5L/min

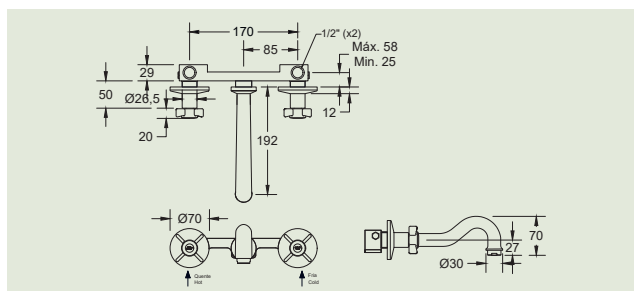

MISTURADORA DE BIDÉ C/ VDA	REF	CROMADO CROMO CHROME	DOURADO DORADO GOLDEN	DOURADO MATE ORO MATE MATT GOLD
		X = 2	X = 4	X = 5

Mezclador de bidé c / VDA
Bidet mixer w/ automatic waste

5063504x

145 €

288 €

288 €

5L/min

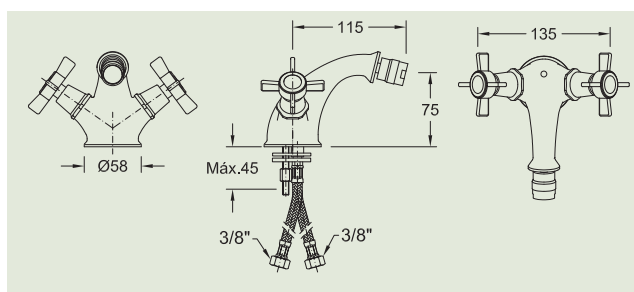

MISTURADORA DE BIDÉ 3 FUROS C/ VDA

REF

CROMADO CROMO CHROME

DOURADO DORADO GOLDEN

DOURADO MATE ORO MATE MATT GOLD

Mezcladora de bidé 3 agujeros c / VDA
Three holes bidet mixer w/ automatic waste

5063534x

X = 2

X = 4

X = 5

274 €

516 €

516 €

5L/min

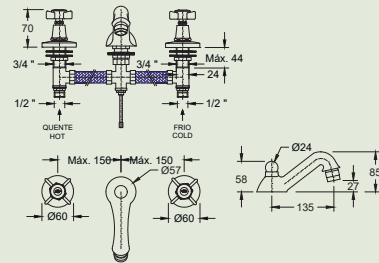

MISTURADORA DE BANHEIRA C/ KIT DE CHUVEIRO MANUAL (8L/MIN.)

REF

CROMADO CROMO CHROME

DOURADO DORADO GOLDEN

DOURADO MATE ORO MATE MATT GOLD

Mezcladora de bañera con kit de ducha manual (8L/min.)
Bath mixer w/ shower kit (8L/min.)

5063505x

X = 2

X = 4

X = 5

242 €

522 €

522 €

8L/min

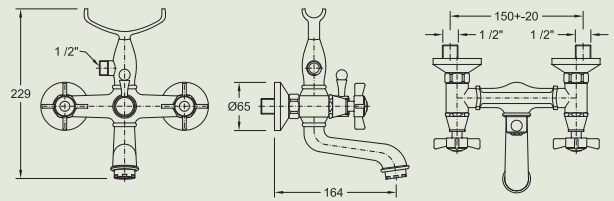

MISTURADORA DE BANHEIRA DE CHÃO C/ KIT DE CHUVEIRO MANUAL (8L/MIN.)

REF

CROMADO CROMO CHROME

DOURADO DORADO GOLDEN

DOURADO MATE ORO MATE MATT GOLD

Mezcladora de bañera de suelo con kit de ducha manual (8L/min.)
Floor bath mixer w/ shower kit (8L/min.)

5063515x

X = 2

X = 4

X = 5

555 €

1.084 €

1.084 €

8L/min

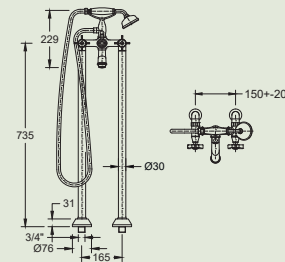

MISTURADORA DE DUCHE C/ KIT DE CHUVEIRO MANUAL (8L/MIN.)

REF

CROMADO CROMO CHROME

DOURADO DORADO GOLDEN

DOURADO MATE ORO MATE MATT GOLD

Mezcladora de ducha con kit de ducha manual (8L/min.)
Shower mixer w/ shower kit (8L/min.)

5063506x

X = 2

X = 4

X = 5

168 €

337 €

337 €

8L/min

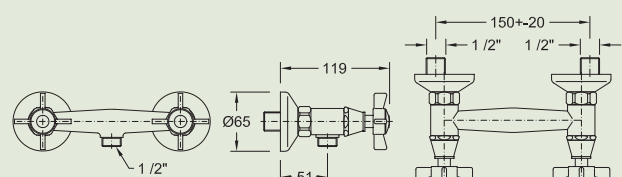

MISTURADORA DE DUCHE MURAL	REF	CROMADO CROMO CHROME	DOURADO DORADO GOLDEN	DOURADO MATE ORO MATE MATT GOLD
Mezcladora de ducha mural Wall mounted shower mixer	5063507x	X = 2	X = 4	X = 5
		154 €	192 €	192 €

MISTURADORA DE DUCHE DE ENCASTRAR C/ INVERSOR 2 VIAS	REF	CROMADO CROMO CHROME	DOURADO DORADO GOLDEN	DOURADO MATE ORO MATE MATT GOLD
Mezclador empotrado de ducha con inversor 2 vias Wall mounted shower mixer with 2-way inverter	5063527x	X = 2	X = 4	X = 5
		206 €	397 €	397 €

MISTURADORA DE DUCHE DE ENCASTRAR C/ INVERSOR 3 VIAS	REF	CROMADO CROMO CHROME	DOURADO DORADO GOLDEN	DOURADO MATE ORO MATE MATT GOLD
Mezclador empotrado de ducha con inversor 3 vias Wall mounted shower mixer with 3-way inverter	5063537x	X = 2	X = 4	X = 5
		227 €	447 €	447 €

MISTURADORA DE BANHEIRA DE COLUNA C/ CHUVEIRO SUPERIOR E KIT DE CHUVEIRO MANUAL	REF	CROMADO CROMO CHROME	DOURADO DORADO GOLDEN	DOURADO MATE ORO MATE MATT GOLD
Mezcladora de banheira de coluna com ducha superior y kit de ducha manual Bath mixer w/ column and shower kit	5063525x	X = 2	X = 4	X = 5
		630 €	1.363 €	1.363 €
<p> 8L/min 10L/min </p>				



MISTURADORA DE DUCHE DE COLUNA C/ CHUVEIRO SUPERIOR E KIT DE CHUVEIRO MANUAL

REF

CROMADO CROMO CHROME

DOURADO DORADO GOLDEN

DOURADO MATE ORO MATE MATT GOLD

Mezcladora de ducha de columna con ducha superior y kit de ducha manual
Shower mixer w/ column and shower kit

5063547x

X = 2

X = 4

X = 5

517 €

1.137 €

1.137 €

8L/min 10L/min

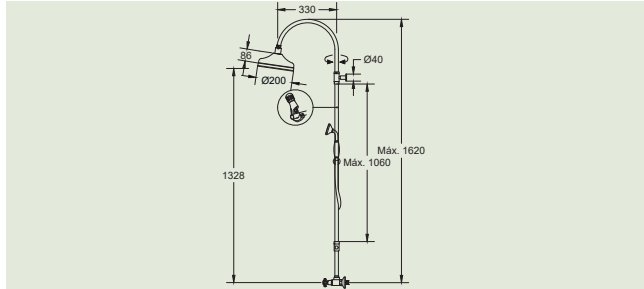

CHUVEIRO DE MÃO

REF

CROMADO CROMO CHROME

DOURADO DORADO GOLDEN

DOURADO MATE ORO MATE MATT GOLD

Ducha de mano (8L/min.)
Hand shower (8L/min.)

8L/min



X = 2

X = 4

X = 5

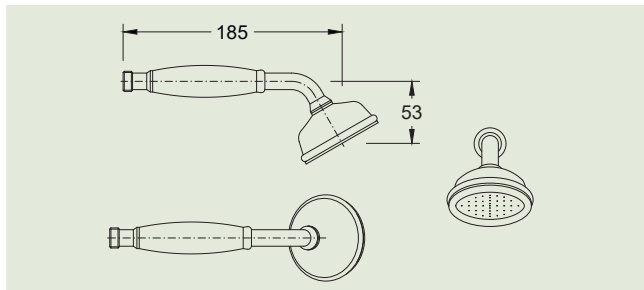

5063591x

51 €

101 €

101 €

SUPORTE DE CHUVEIRO

Soporte de ducha
Shower holder

5063500x

21 €

48 €

48 €

TOMADA DE ÁGUA C/ SUPORTE DE CHUVEIRO

REF

CROMADO CROMO CHROME

DOURADO DORADO GOLDEN

DOURADO MATE ORO MATE MATT GOLD

Conexión de agua con soporte de ducha de mano
Water outlet w/ hand shower support

5063592x

X = 2

X = 4

X = 5

53 €

105 €

105 €

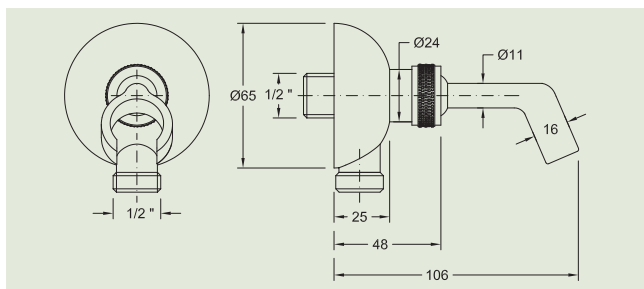

	REF	CROMADO CROMO CHROME	DOURADO DORADO GOLDEN	DOURADO MATE ORO MATE MATT GOLD
CHUVEIRO DE TECTO EM LATÃO (8L/MIN.)				
Ducha de techo en laton (8L/min.) Brass head shower (8L/min.)		X = 2	X = 4	X = 5
	5063593x	173 €	342 €	342 €
FLEXÍVEL DUPLA GRAFATURA 150CM				
Manguera de ducha de mano 150cm Shower flexible hose 150cm		X = 2		
	5061702x	14 €		
FLEXÍVEL PVC ANTI TORSÃO 150CM				
Manguera de ducha PVC anti torsión 150cm PVC anti torsion shower flexible hose 150cm		X = 2	X = 4	X = 5
	5061704x	18 €	41 €	41 €
VÁLVULA CLIC-CLAC				
Válvula clic-clac Pop-up waste		X = 2	X = 4	X = 5
	5511002x	20 €	75 €	75 €
VÁLVULA DE DESCARGA AUTOMÁTICA				
Válvula de desagüe automática Automatic discharge valve		X = 2	X = 4	X = 5
	5063590x	34 €	67 €	67 €
TORNEIRA DE PASSAGEM DE 1/2"				
Grifo de corte de 1/2 " Cutting tap 1/2"		X = 2	X = 4	X = 5
	5063540x	41 €	80 €	80 €
TORNEIRA DE PASSAGEM DE 3/4"				
Grifo de corte de 3/4 " Cutting tap 3/4"		X = 2	X = 4	X = 5
	5063543x	53 €	105 €	105 €
TORNEIRA DE ESQUADRIA 1/2" x 3/8"				
Grifo de escuadra 1/2 " x 3/8" Cutting tap 1/2 " x 3/8"		X = 2	X = 4	X = 5
	5063544x	42 €	80 €	80 €
TORNEIRA DE ESQUADRIA 1/2" x 1/2"				
Grifo de escuadra 1/2 " x 1/2" Cutting tap 1/2 " x 1/2"		X = 2	X = 4	X = 5
	5063545x	42 €	80 €	80 €



MONOCOMANDO DE LAVATÓRIO C/ VCC

REF

CROMADO CROMO CHROME

PRETO MATE NEGRO MATE BLACK MATT

NIQUEL ESCOVADO NIQUEL PULIDO BRUSHED NICKEL

Monocomando de lavabo con VCC
Single lever washbasin mixer with VCC

5L/min

5061502x

X = 2

X = 3

X = 0

111 €

165 €

165 €

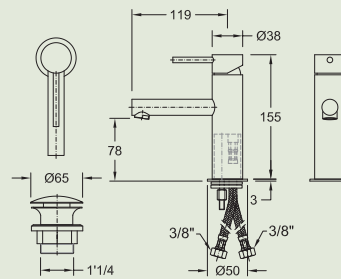

MONOCOMANDO DE LAVATÓRIO C/ VCC PARA LAVATÓRIO EGG SUSPENSO

REF

CROMADO CROMO CHROME

PRETO MATE NEGRO MATE BLACK MATT

NIQUEL ESCOVADO NIQUEL PULIDO BRUSHED NICKEL

Monomando de lavabo con VCC para lavabo EGG suspenso
Single lever washbasin mixer with VCC for wall hung EGG washbasin

5L/min

5061532x

X = 2

X = 3

X = 0

151 €

227 €

227 €

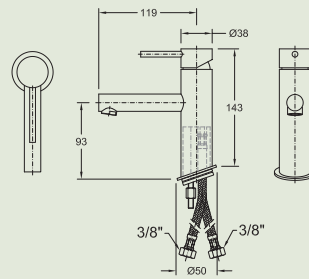

MONOCOMANDO DE LAVATÓRIO ALTO C/ VCC

REF

CROMADO CROMO CHROME

PRETO MATE NEGRO MATE BLACK MATT

NIQUEL ESCOVADO NIQUEL PULIDO BRUSHED NICKEL

Monocomando de lavabo alto c/ VCC
Bowl mixer with VCC

5L/min

5061512x

X = 2

X = 3

X = 0

174 €

259 €

259 €

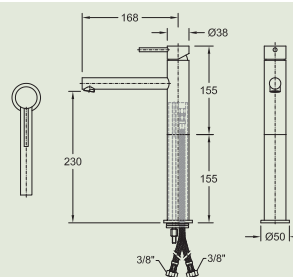

MONOCOMANDO DE CHÃO DE LAVATÓRIO ALTO C/ VCC

REF

CROMADO CROMO CHROME

PRETO MATE NEGRO MATE BLACK MATT

NIQUEL ESCOVADO NIQUEL PULIDO BRUSHED NICKEL

Monocomando de suelo de lavabo alto c/ VCC
Single lever floor washbasin mixer with VCC

5L/min

5061582x

X = 2

X = 3

X = 0

604 €

699 €

699 €



MONOCOMANDO DE LAVATÓRIO DE PAREDE C/ ESPELHO RETANGULAR E VCC	REF	CROMADO CROMO CHROME	PRETO MATE NEGRO MATE BLACK MATT	NIQUEL ESCOVADO NIQUEL PULIDO BRUSHED NICKEL

Monocomando de lavabo de pared con espejo rectangular y VCC
Wall mounted single lever washbasin with rectangular mirror and VCC

5061522x

5L/min



X = 2	X = 3	X = 0
190 €	286 €	286 €

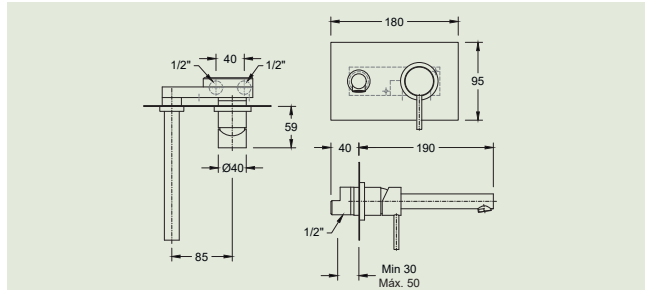

MONOCOMANDO DE LAVATÓRIO DE PAREDE C/ ESPELHOS REDONDOS E VCC	REF	CROMADO CROMO CHROME	PRETO MATE NEGRO MATE BLACK MATT	NIQUEL ESCOVADO NIQUEL PULIDO BRUSHED NICKEL

Monocomando de lavabo de pared con espejos redondos y VCC
Wall mounted single lever washbasin with round mirrors and VCC

5061562x

5L/min



X = 2	X = 3	X = 0
161 €	242 €	242 €

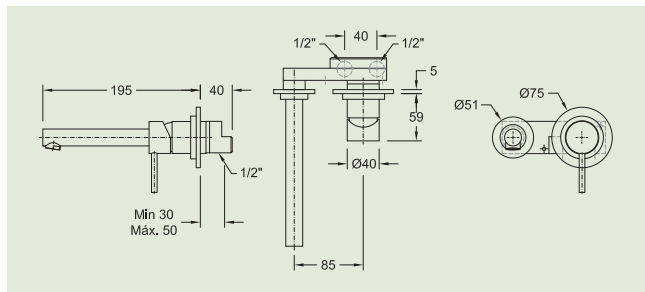

MONOCOMANDO DE BIDÉ C/ VCC	REF	CROMADO CROMO CHROME	PRETO MATE NEGRO MATE BLACK MATT	NIQUEL ESCOVADO NIQUEL PULIDO BRUSHED NICKEL

Monocomando de bidé c/ VCC
Single lever bidet mixer with VCC

5061504x

5L/min



X = 2	X = 3	X = 0
114 €	173 €	173 €

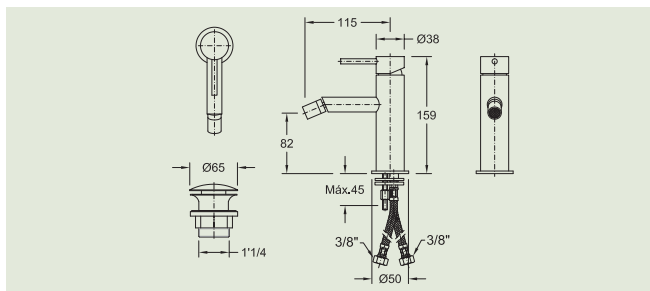

MONOCOMANDO DE BANHEIRA C/ KIT DE CHUVEIRO MANUAL	REF	CROMADO CROMO CHROME	PRETO MATE NEGRO MATE BLACK MATT	NIQUEL ESCOVADO NIQUEL PULIDO BRUSHED NICKEL

Monocomando de bañera con kit de ducha manual
Single lever bath mixer with shower kit

5061505x

6L/min



X = 2	X = 3	X = 0
213 €	426 €	426 €

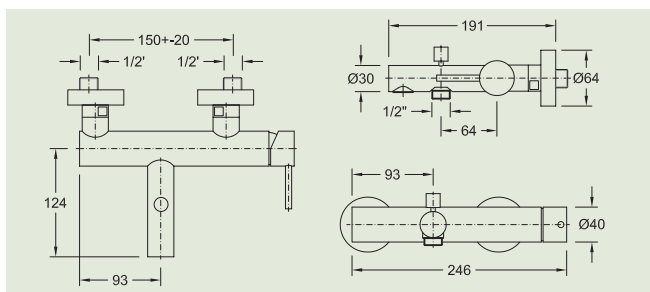

MONOCOMANDO DE CHÃO DE BANHEIRA C/ KIT DE CHUVEIRO MANUAL REF

Monocomando de suelo de bañera con kit de ducha manual
Single lever floor bath mixer with shower kit

6L/min



5061515x

CROMADO CROMO CHROME

PRETO MATE NEGRO MATE BLACK MATT

NIQUEL ESCOVADO NIQUEL PULIDO BRUSHED NICKEL

X = 2

X = 3

X = 0

686 €

1.371 €

1.371 €

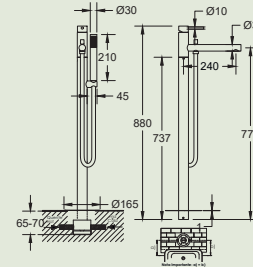

MONOCOMANDO DE DUCHE C/ KIT DE CHUVEIRO MANUAL REF

Monocomando de ducha con kit de ducha manual
Single lever shower mixer with shower kit

6L/min



5061506x

CROMADO CROMO CHROME

PRETO MATE NEGRO MATE BLACK MATT

NIQUEL ESCOVADO NIQUEL PULIDO BRUSHED NICKEL

X = 2

X = 3

X = 0

181 €

362 €

362 €

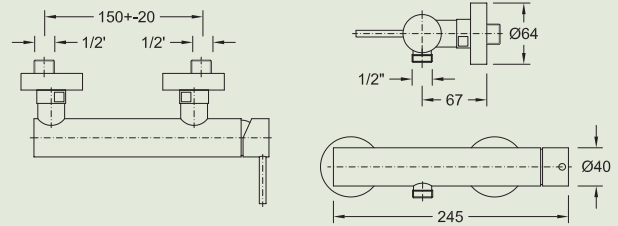

MONOCOMANDO DE DUCHE MURAL REF

Monocomando de ducha mural
Wall mounted single lever shower mixer

5061507x

CROMADO CROMO CHROME

PRETO MATE NEGRO MATE BLACK MATT

NIQUEL ESCOVADO NIQUEL PULIDO BRUSHED NICKEL

X = 2

X = 3

X = 0

92 €

137 €

137 €

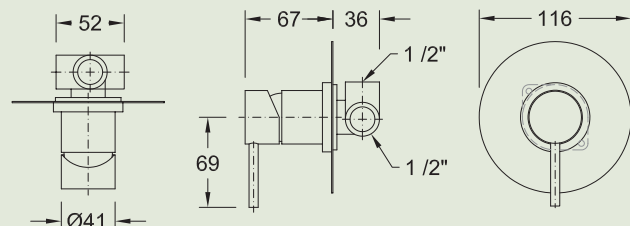

MONOCOMANDO DE DUCHE MURAL C/ INVERSOR DE 2 SAÍDAS REF

Monocomando de ducha mural con inversor de 2 salidas
Wall-mounted single lever bath/shower mixer

5061517x

CROMADO CROMO CHROME

PRETO MATE NEGRO MATE BLACK MATT

NIQUEL ESCOVADO NIQUEL PULIDO BRUSHED NICKEL

X = 2

X = 3

X = 0

174 €

259 €

259 €

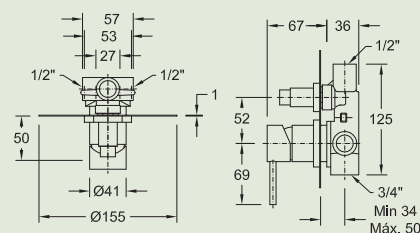

MONOCOMANDO DE DUCHE MURAL C/ ESPELHOS REDONDOS E INVERSOR DE 2 VIAS E KIT DE CHUVEIRO

REF

CROMADO CROMO CHROME

PRETO MATE NEGRO MATE BLACK MATT

NIQUEL ESCOVADO NIQUEL PULIDO BRUSHED NICKEL

Mezclador de ducha de pared con espejos redondos, inversor de 2 vías y kit de ducha. Wall mounted shower mixer with round mirrors and 2-way inverter and shower kit

5062557x

6L/min



X = 2

X = 3

X = 0

271 €

408 €

408 €

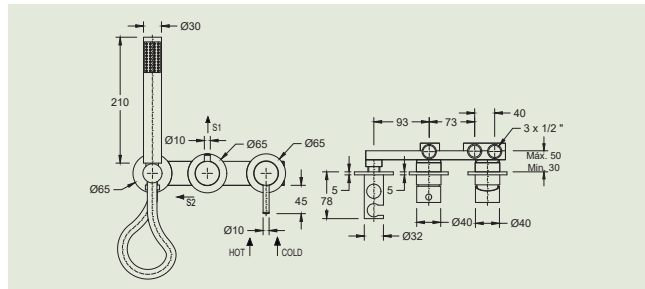

MONOCOMANDO DE DUCHE MURAL C/ ESPELHOS REDONDOS E INVERSOR DE 3 VIAS E KIT DE CHUVEIRO

REF

CROMADO CROMO CHROME

PRETO MATE NEGRO MATE BLACK MATT

NIQUEL ESCOVADO NIQUEL PULIDO BRUSHED NICKEL

Mezclador de ducha de pared con espejos redondos, inversor de 3 vías y kit de ducha. Wall mounted shower mixer with round mirrors and 3-way inverter and shower kit

5062577x

6L/min



X = 2

X = 3

X = 0

302 €

450 €

450 €

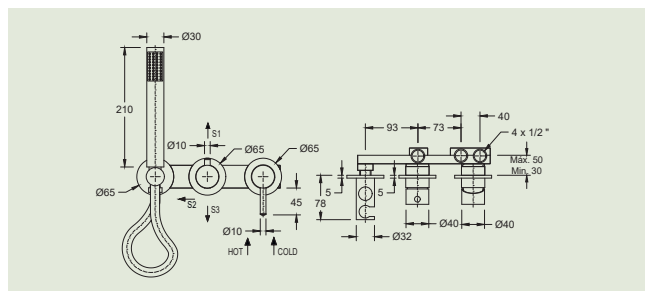

MONOCOMANDO DE DUCHE MURAL C/ ESPELHO RECTANGULAR E INVERSOR DE 3 VIAS E KIT DE CHUVEIRO

REF

CROMADO CROMO CHROME

PRETO MATE NEGRO MATE BLACK MATT

NIQUEL ESCOVADO NIQUEL PULIDO BRUSHED NICKEL

Monocomando de ducha mural c/ espejos rectangular c/ distribuidor de 3 salidas y kit de ducha. Wall-mounted single lever shower mixer w/ rectangular mirrors w/ 3 ways diverter and shower kit

5061567x

6L/min



X = 2

X = 3

X = 0

325 €

489 €

489 €

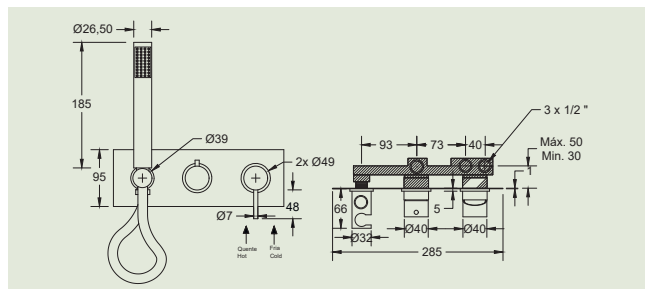

MONOCOMANDO DE DUCHE MURAL C/ ESPELHO RECTANGULAR E INVERSOR DE 2 VIAS E KIT DE CHUVEIRO

REF

CROMADO CROMO CHROME

PRETO MATE NEGRO MATE BLACK MATT

NIQUEL ESCOVADO NIQUEL PULIDO BRUSHED NICKEL

Monocomando de ducha mural c/ espejos rectangular c/ distribuidor de 2 salidas y kit de ducha

5061547x

Wall-mounted single lever shower mixer w/ rectangular mirrors w/ 2 ways diverter and shower kit

6L/min



X = 2

X = 3

X = 0

303 €

454 €

454 €

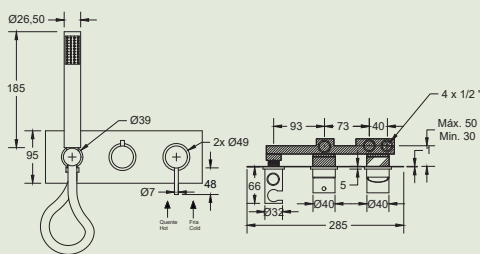

TOMADA DE ÁGUA C/ SUPORTE PARA CHUVEIRO DE MÃO

REF

CROMADO CROMO CHROME

PRETO MATE NEGRO MATE BLACK MATT

NIQUEL ESCOVADO NIQUEL PULIDO BRUSHED NICKEL

Conexión de agua con soporte de ducha de mano

Water outlet w/ hand shower support

5517302x



X = 2

X = 3

X = 0

34 €

51 €

51 €



MONOCOMANDO DE COZINHA C/ BICA ROTATIVA

REF

CROMADO CROMO CHROME

PRETO MATE NEGRO MATE BLACK MATT

NIQUEL ESCOVADO NIQUEL PULIDO BRUSHED NICKEL

Monomando para fregadero con caño giratorio

Single lever sink mixer with rotating spout

5062547x

6L/min



X = 2

X = 3

X = 0

135 €

209 €

209 €

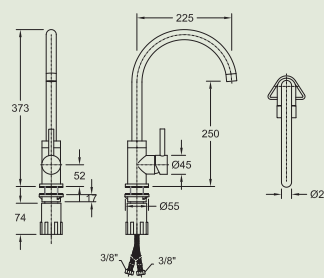

MONOCOMANDO DE COZINHA C/ BICA ROTATIVA E CHUVEIRO ESTENSÍVEL DE 2 JATOS

REF

CROMADO CROMO CHROME

PRETO MATE NEGRO MATE BLACK MATT

NIQUEL ESCOVADO NIQUEL PULIDO BRUSHED NICKEL

Monomando de cocina con caño giratorio y rociador extensible de dos chorros

Single-lever kitchen mixer w/ rotating spout and extendable two jet-showerhead

5061558x

6L/min



X = 2

X = 3

X = 0

165 €

248 €

248 €

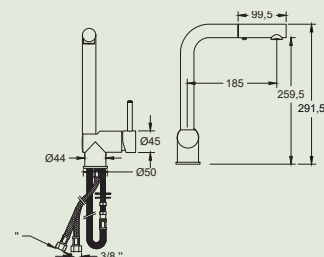

TORNEIRA MURAL C/ KIT HIGIÉNICO

REF

CROMADO
CROMO
CHROMEPRETO MATE
NEGRO MATE
BLACK MATTNIQUEL ESCOVADO
NIQUEL PULIDO
BRUSHED NICKELGrifo de pared con kit de higiénico
Wall mounted tap w/ hygienic kit

5061524x

X = 2

X = 3

X = 0

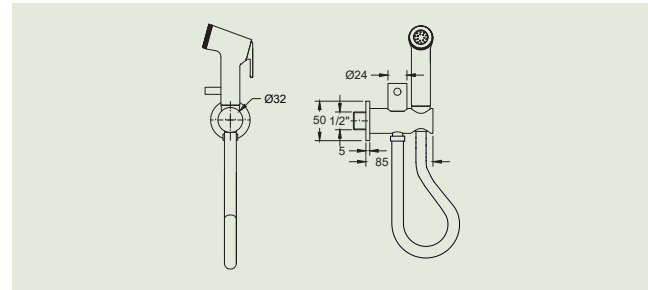

MONOCOMANDO MURAL C/ KIT HIGIÉNICO

REF

CROMADO
CROMO
CHROMEPRETO MATE
NEGRO MATE
BLACK MATTNIQUEL ESCOVADO
NIQUEL PULIDO
BRUSHED NICKELMonomando de pared c/ kit higiénico
Wall mounted single lever w/
hygienic kit

5069100x

X = 2

X = 3

X = 0

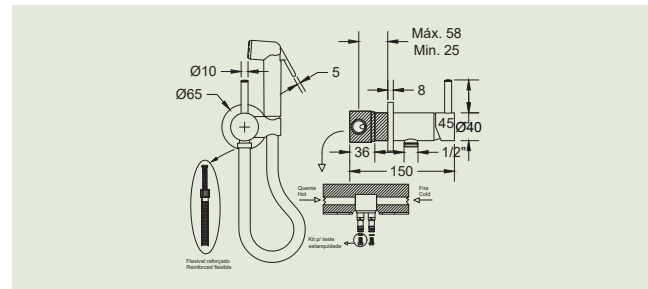

HASTE DE PAREDE 35CM

REF

CROMADO
CROMO
CHROMEPRETO MATE
NEGRO MATE
BLACK MATTNIQUEL ESCOVADO
NIQUEL PULIDO
BRUSHED NICKELBarra mural para ducha 35cm
Wall rod 35cm

5069723x

X = 2

X = 3

X = 0

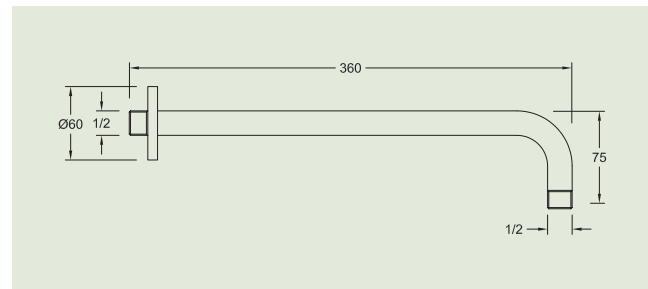

HASTE DE TECTO 15CM

REF

CROMADO
CROMO
CHROMEPRETO MATE
NEGRO MATE
BLACK MATTNIQUEL ESCOVADO
NIQUEL PULIDO
BRUSHED NICKELBarra de techo 15cm
Ceilling rod 15cm

5069724x

X = 2

X = 3

X = 0

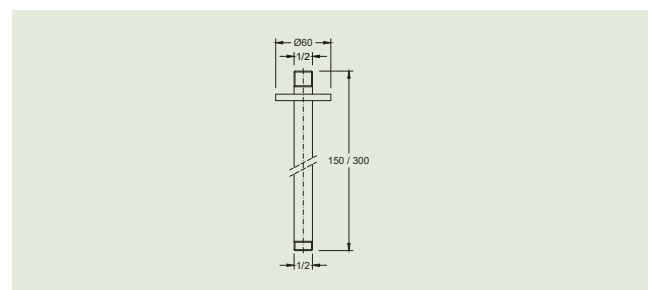

CHUVEIRO DE MÃO (8L/MIN.)

REF

CROMADO
CROMO
CHROMEPRETO MATE
NEGRO MATE
BLACK MATTNIQUEL ESCOVADO
NIQUEL PULIDO
BRUSHED NICKELDucha de mão (8 L/min.)
Hand shower (8 L/min.)

5069706x

X = 2

X = 3

X = 0

22 €

55 €

55 €

CHUVEIRO DE TECTO 20CM REDONDO EM ABS (8 L/MIN.)

REF

CROMADO
CROMO
CHROMEPRETO MATE
NEGRO MATE
BLACK MATTNIQUEL ESCOVADO
NIQUEL PULIDO
BRUSHED NICKELDucha de tecto 20cm ABS (8 L/min.)
ABS head shower 20cm (8 L/min.)

5068308x

X = 2

X = 3

X = 0

38 €

54 €

54 €

CHUVEIRO DE TECTO 20CM REDONDO EM LATÃO (8L/MIN.)

REF

CROMADO
CROMO
CHROMEPRETO MATE
NEGRO MATE
BLACK MATTNIQUEL ESCOVADO
NIQUEL PULIDO
BRUSHED NICKELDucha de tecto en laton 20cm redondo
(8 L/min.)
Brass head shower 20cm (8 L/min.)

5068311x

X = 2

X = 3

X = 0

119 €

159 €

159 €

FLEXÍVEL DUPLA GRAFATURA 150CM

REF

CROMADO
CROMO
CHROMEPRETO MATE
NEGRO MATE
BLACK MATTNIQUEL ESCOVADO
NIQUEL PULIDO
BRUSHED NICKELManguera de ducha de mão 150cm
Shower flexible hose 150cm

5061702x

X = 2

X = 3

X = 0

14 €

53 €

53 €

FLEXÍVEL PVC ANTI TORSÃO 150CM

REF

CROMADO
CROMO
CHROMEPRETO MATE
NEGRO MATE
BLACK MATTNIQUEL ESCOVADO
NIQUEL PULIDO
BRUSHED NICKELManguera de ducha PVC
anti torsión 150cm
PVC anti torsion shower
flexible hose 150cm

5061704x

X = 2

X = 3

X = 0

18 €

26 €

26 €

BICA DE BANHEIRA ENCASTRÁVEL 1/2"

REF

CROMADO
CROMO
CHROMEPRETO MATE
NEGRO MATE
BLACK MATTNIQUEL ESCOVADO
NIQUEL PULIDO
BRUSHED NICKELBica de baniera empotrable 1/2"
Wall mounted bath spout 1/2"

5062555x

X = 2

X = 3

X = 0

56 €

83 €

83 €

SIFÃO CILÍNDRICO

REF

CROMADO
CROMO
CHROMEPRETO MATE
NEGRO MATE
BLACK MATTNIQUEL ESCOVADO
NIQUEL PULIDO
BRUSHED NICKELSifón cilíndrico
Cilindric siphon

5510913x

X = 2

X = 3

X = 0

45 €

68 €

68 €

VÁLVULA CLIC-CLAC

REF

CROMADO
CROMO
CHROMEPRETO MATE
NEGRO MATE
BLACK MATTNIQUEL ESCOVADO
NIQUEL PULIDO
BRUSHED NICKELVálvula clic-clac
Pop-up waste

5511002x

X = 2

X = 3

X = 0

20 €

28 €

28 €

MONOCOMANDO DE LAVATÓRIO VCC

REF

CROMADO
CROMO
CHROMEMonocomando de lavabo VCC
Single lever washbasin mixer VCC

50612022

84 €

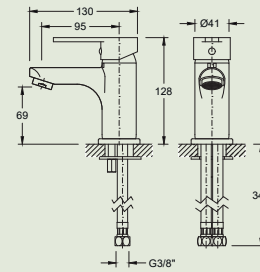
 5L/min
**MONOCOMANDO DE LAVATÓRIO ALTO VCC**

REF

CROMADO
CROMO
CHROMEMonocomando de lavabo alto VCC
Bowl single lever washbasin mixer VCC

50612122

148 €

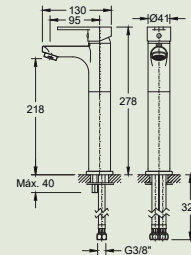
 5L/min
**MONOCOMANDO DE LAVATÓRIO MURAL VCC**

REF

CROMADO
CROMO
CHROMEMonocomando de lavabo mural VCC
Single lever wall mounted washbasin mixer VCC

50612222

189 €

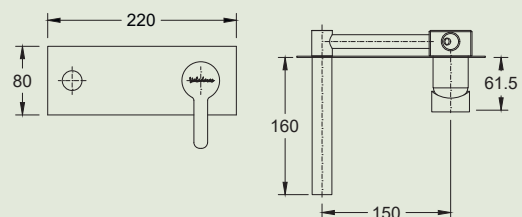
 5L/min
**MONOCOMANDO DE BIDÉ VCC**

REF

CROMADO
CROMO
CHROMEMonocomando de bidé VCC
Single lever bidet mixer VCC

50612042

87 €

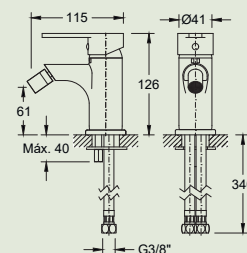
 5L/min

MONOCOMANDO DE BANHEIRA C/ KIT DE CHUVEIRO

REF

CROMADO
CROMO
CHROME

Monocomando de banheira com kit de ducha
Single lever bathtub mixer with shower kit

50612052

113 €

 9L/min  21L/min

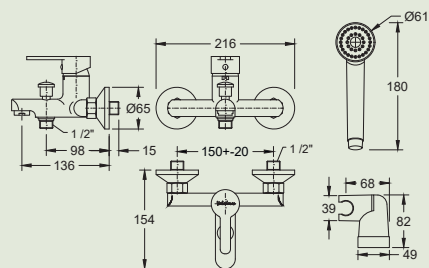
**MONOCOMANDO DE DUCHE C/ KIT DE CHUVEIRO**

REF

CROMADO
CROMO
CHROME

Monocomando de ducha com kit de ducha
Single lever shower mixer with shower kit

50612062

97 €

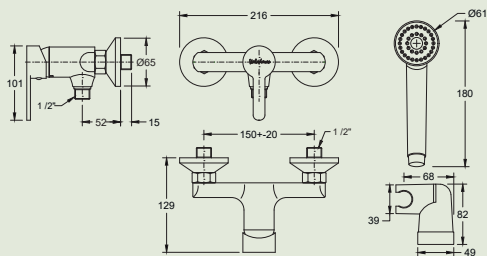
**MONOCOMANDO DE DUCHE MURAL 1 SAÍDA**

REF

CROMADO
CROMO
CHROME

Monocomando de ducha mural 1 saída
Wall mounted shower mixer 1 outlet

50612072

108 €

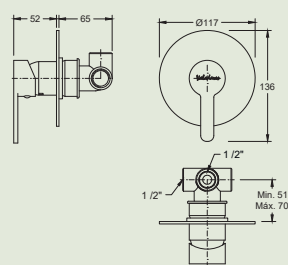
**MONOCOMANDO DE DUCHE MURAL 2 SAÍDAS**

REF

CROMADO
CROMO
CHROME

Monocomando de ducha mural 2 saídas
Wall mounted shower mixer 2 outlets

50612172

169 €

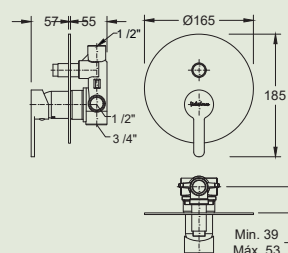

MONOCOMANDO DE LAVA-LOUÇA

REF

CROMADO
CROMO
CHROMEMonocomando de cocina
Single lever dishwasher mixer

50612482

134 €

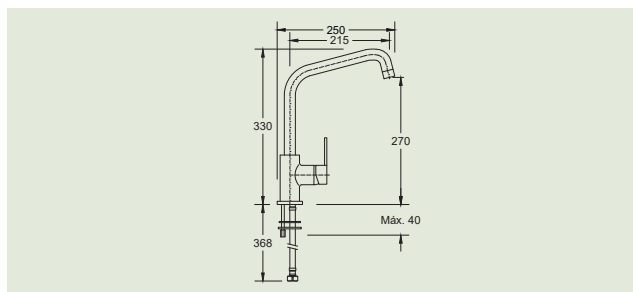
 12L/min
**CHUVEIRO DE MÃO**

REF

CROMADO
CROMO
CHROMEDucha de mano
Hand shower

50612972

15 €

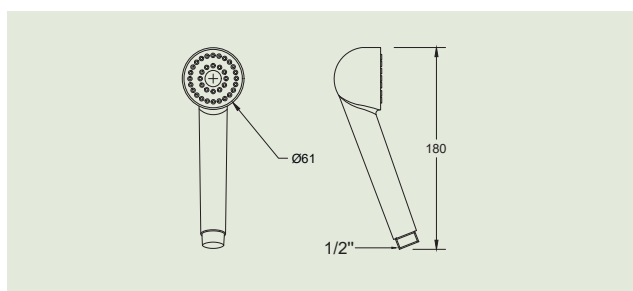
 9L/min
**FLEXÍVEL DE CHUVEIRO**

REF

CROMADO
CROMO
CHROMETubo flexível de ducha
Hand shower flexible hose

50617022

14 €

**TOMADA DE ÁGUA**

REF

CROMADO
CROMO
CHROMEConexión de agua de pared
Wall mounted water connection

55173032

28 €

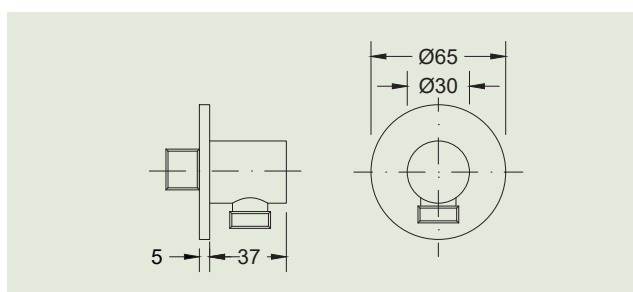

RAMPA DE CHUVEIRO

REF

CROMADO
CROMO
CHROMEWall mounted water connection
Shower rail

50695082

53 €

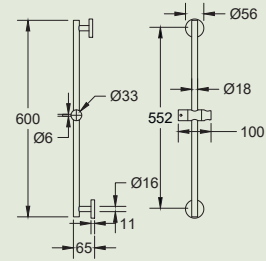

SUPORTE DE CHUVEIRO DE MÃO

REF

CROMADO
CROMO
CHROMESoporte para ducha de mano
Hand shower holder

50697002

8 €

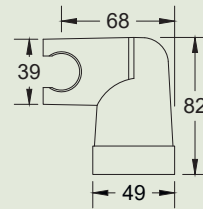

BICA DE ENCASTRAR P/ BANHEIRA

REF

CROMADO
CROMO
CHROMECaño empotrado para banheira
Wall mounted spout for bathtub

50615552

56 €

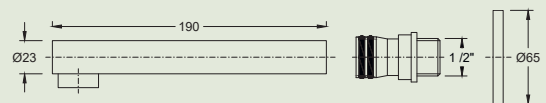

TORNEIRA DE LAVATÓRIO 220V

REF

CROMADO
CROMO
CHROMEGrifo para lavabo 220V
Washbasin tap 220V

50602022

248 €

5L/min

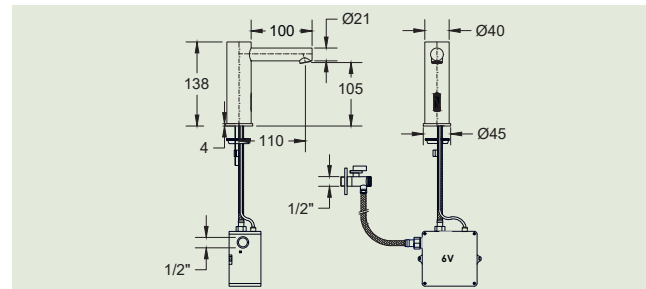

TORNEIRA DE LAVATÓRIO ALTO 220V

REF

CROMADO
CROMO
CHROMEGrifo para lavabo alto 220V
Bowl tap 220V

50602032

297 €

5L/min

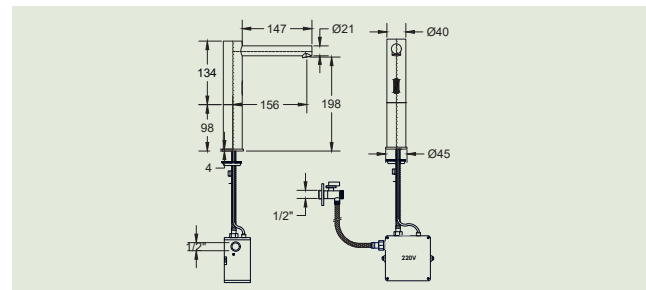

TORNEIRA DE LAVATÓRIO MURAL 220V

REF

CROMADO
CROMO
CHROMEGrifo para lavabo de parede 220V
Wall mounted washbasin tap 220V

50602042

279 €

5L/min

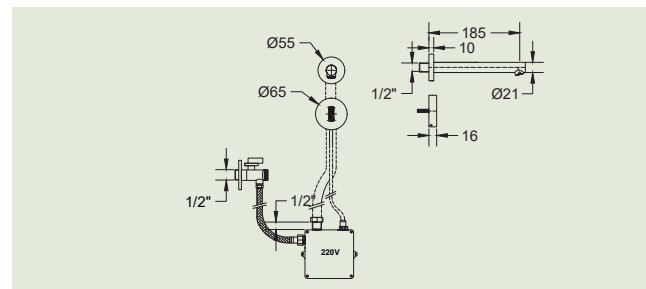

TORNEIRA URINOL EXTERIOR 6V

REF

CROMADO
CROMO
CHROMEGrifo para urinário exterior 6V
Urinal faucet 6V

50602052

418 €

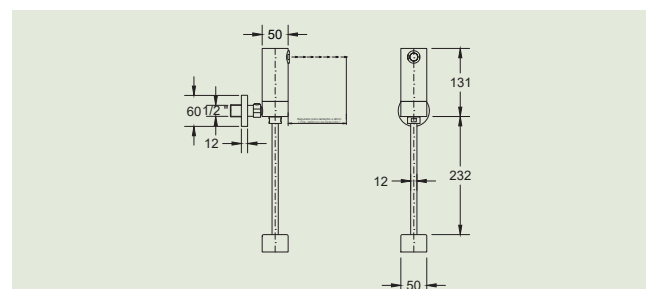

TORNEIRA URINOL MURAL 220V

REF

CROMADO
CROMO
CHROME

Grifo para urinario de pared 220V
Wall mounted urinal faucet 220V

50602062

337 €

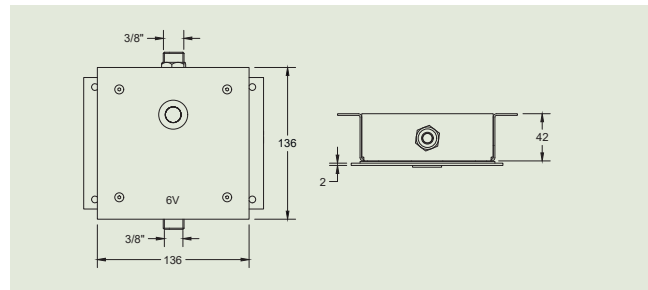

KIT DE PRÉ-MISTURA P/ TORNEIRAS DE LAVATÓRIO

REF

CROMADO
CROMO
CHROME

Kit de premezcla para grifería de lavabo
Pre-mix kit for washbasin taps

50602072

37 €

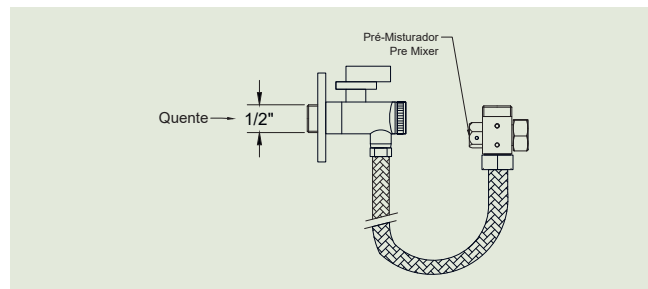

MISTURADORA DE LAVATÓRIO

REF

CROMADO
CROMO
CHROMEMezcladora de lavabo
Washbasin mixer

50682022

149 €

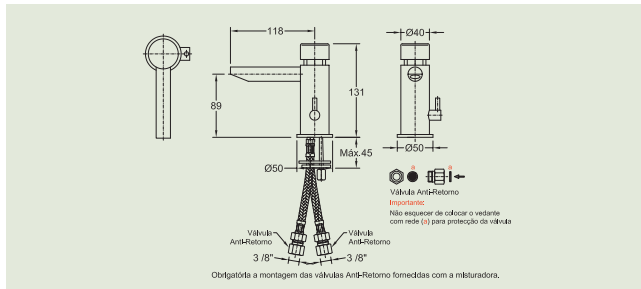
 5L/min

TORNEIRA DE LAVATÓRIO

REF

CROMADO
CROMO
CHROMEGrifo de lavabo
Washbasin tap

50667112

86 €

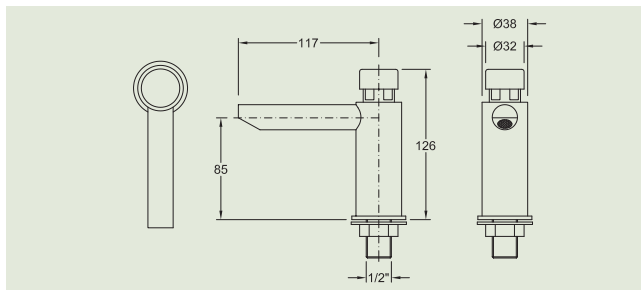
 5L/min



MONOCOMANDO DE LAVATÓRIO

REF

CROMADO
CROMO
CHROMEMonocomando de lavabo
Single lever basin mixer

50609512

240 €

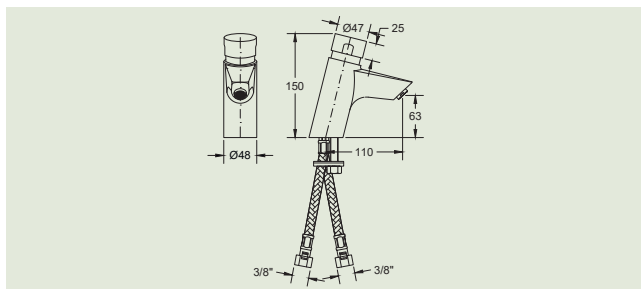
 5L/min

TORNEIRA DE LAVATÓRIO ECO

REF

CROMADO
CROMO
CHROMEGrifo de lavabo ECO
Washbasin tap ECO

50609012

63 €

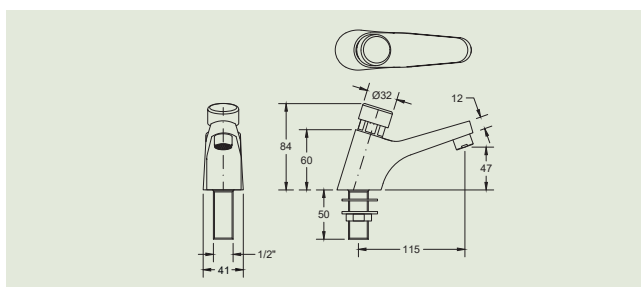

TORNEIRA MURAL DE LAVATÓRIO ECO

REF

CROMADO
CROMO
CHROME

Grifo mural de lavabo ECO
Wall mounted washbasin tap ECO

50609612

72 €

5L/min

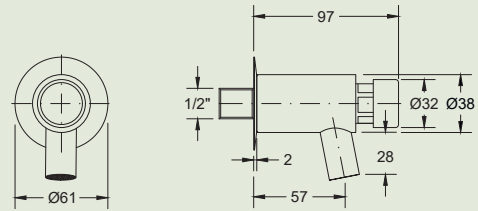

TORNEIRA MURAL DE LAVATÓRIO

REF

CROMADO
CROMO
CHROME

Grifo mural de lavabo
Wall mounted washbasin tap

50609712

125 €

5L/min

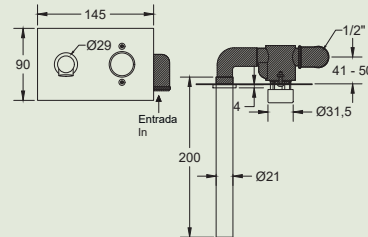

TORNEIRA MURAL DE DUCHE ANTI FURTO

REF

CROMADO
CROMO
CHROME

Grifo mural de ducha antihurto
Wall mounted shower ap anti theft

50609072

55 €

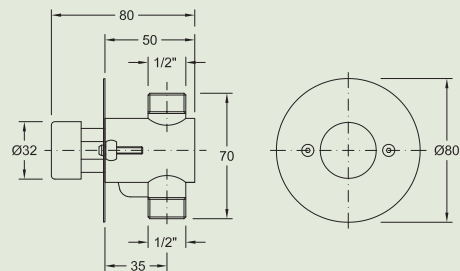

MISTURADORA DE DUCHE DE ENCASTRAR

REF

CROMADO
CROMO
CHROME

Mezclador de ducha empotrado
Wall mounted shower mixer

50667092

210 €

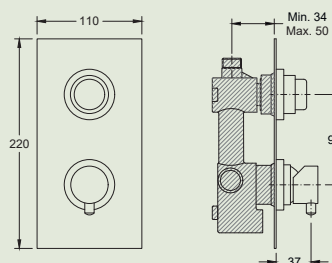

MONOCOMANDO MURAL DE DUCHE

REF

CROMADO
CROMO
CHROMEMonocomando mural de ducha
Wall mounted single lever shower
mixer

50609172

318 €

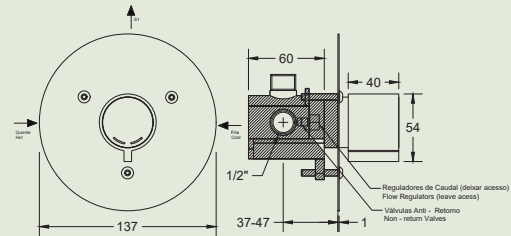
CHUVEIRO À PAREDE
ANTI VANDALISMO

REF

CROMADO
CROMO
CHROMEDucha de pared antivandaismo
Wall mounted antivandalism shower

6L/min

50609902

72 €

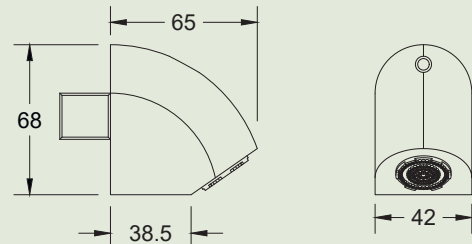
TORNEIRA DE ESQUADRIA DE
URINOL C/ KIT DE DESCARGA

REF

CROMADO
CROMO
CHROMEGrifo de urinário exterior
c/ kit de descarga
External tap for urinal w/ flush Kit

50609392

63 €

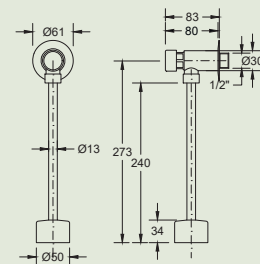

TORNEIRA MURAL DE URINOL

REF

CROMADO
CROMO
CHROMEGrifo de urinário mural
Wall mounted urinal tap

50609192

52 €

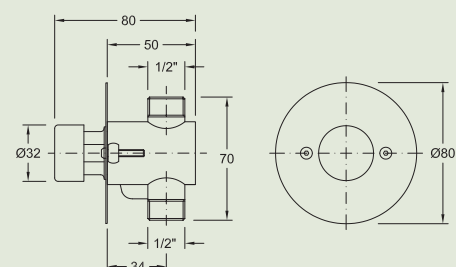

FLUXÓMETRO DE URINOL EXTERIOR C/ REGULAÇÃO DE CAUDAL

REF

CROMADO
CROMO
CHROME

Fluxor exterior para urinário com regulação de fluxo
Urinal flowmeter with flow regulation

50609292

96 €

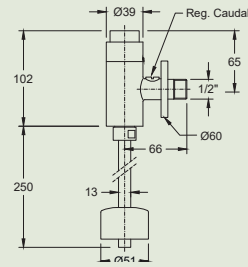

FLUXÓMETRO DE SANITA DE ENCASTRAR

REF

CROMADO
CROMO
CHROME

Fluxor mural para inodoro
Wall mounted WC flowmeter

50609182

82 €

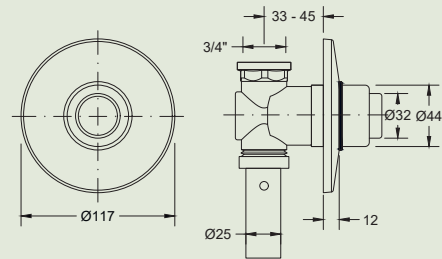

TUBO DE DESCARGA PARA FLUXÓMETRO DE SANITA DE ENCASTRAR

REF

Tubo de descarga para fluxor de inodoro mural
Discharge tube for wall mounted WC flowmeter

55067010

38 €

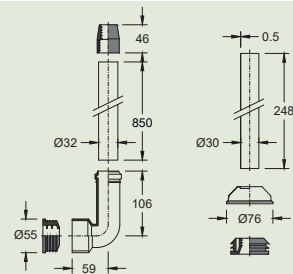

FLUXÓMETRO DE SANITA EXTERIOR

REF

CROMADO
CROMO
CHROME

Fluxor de inodoro exterior
External WC flowmeter

50609082

115 €

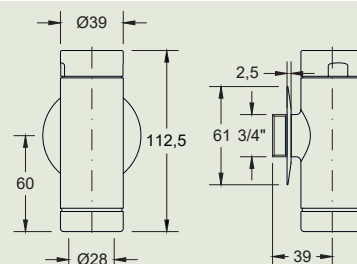

**FLUXÓMETRO DE SANITA
EXTERIOR C/ REGULAÇÃO DE CAUDAL**

REF

CROMADO
CROMO
CHROME

Fluxor de inodoro exterior con
regulación de flujo
External WC flowmeter with flow
regulation

50609282

128 €

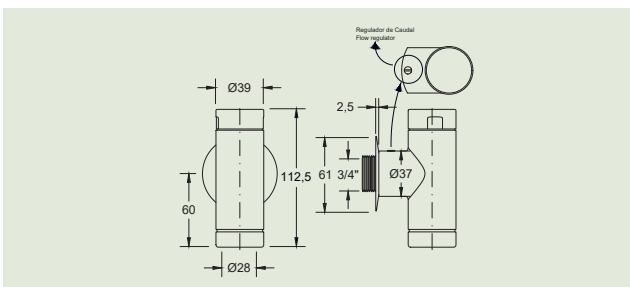
**TUBO DE DESCARGA PARA
FLUXÓMETRO DE SANITA**

REF

CROMADO
CROMO
CHROME

Tubo de descarga para fluxor de
inodoro exterior
Discharge tube for external WC
flowmeter

50609102

44 €



MISTURADORA DE DUCHE TERMOESTÁTICA

REF

CROMADO
CROMO
CHROME

Mezclador termostático de ducha
Thermostatic shower mixer

50601202

242 €

6L/min

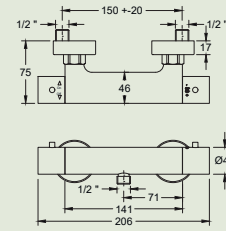

MISTURADORA DE BANHEIRA TERMOESTÁTICA

REF

CROMADO
CROMO
CHROME

Mezclador termostático de banheira
Thermostatic bathtub mixer

50601302

282 €

6L/min

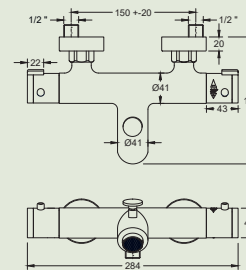

MISTURADORA DE DUCHE MURAL TERMOESTÁTICA 1 SAÍDA

REF

CROMADO
CROMO
CHROME

Mezclador termostático de ducha de pared 1 saída
Wall mounted thermostatic shower mixer 1 way

50615972

289 €

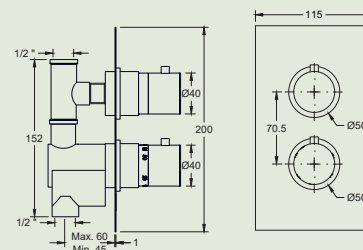

**MISTURADORA DE DUCHE MURAL
TERMOESTÁTICA 2 SAÍDAS**

REF

CROMADO
CROMO
CHROME

Mezclador termostático de ducha de
pared 2 salidas
Wall mounted thermostatic shower
mixer 2 ways

50615772

337 €

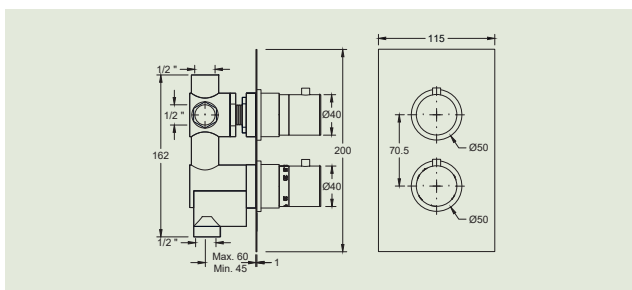
**MISTURADORA DE DUCHE MURAL
TERMOESTÁTICA 3 SAÍDAS**

REF

CROMADO
CROMO
CHROME

Mezclador termostático de ducha de
pared 3 salidas
Wall mounted thermostatic shower
mixer 3 ways

50615872

349 €

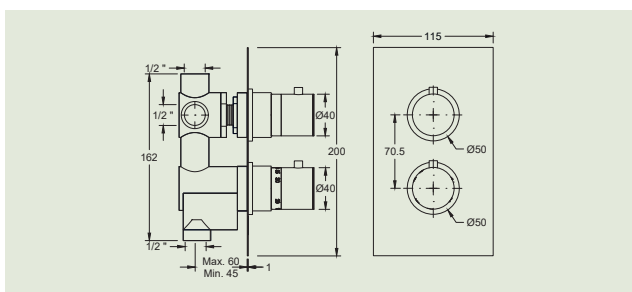

MISTURADORA DUCHE C/ COLUNA TELESCÓPICA E CHUVEIRO DIÂM. 20CM

REF

CROMADO CROMO CHROME

PRETO MATE NEGRO MATE BLACK MATT

NIQUEL ESCOVADO NIQUEL PULIDO BRUSHED NICKEL

Mezclador ducha c/ columna telescópico y ducha diam. 20cm
Shower mixer with telescopic column and shower diam. 20cm

5068031x

X = 2

X = 3

X = 0

387 €

726 €

726 €

6L/min 10L/min

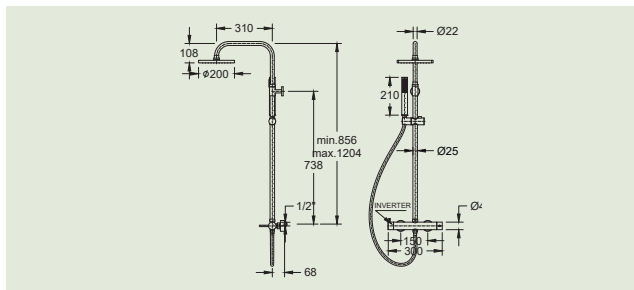

MISTURADORA DUCHE C/ COLUNA TELESCÓPICA E CHUVEIRO DIÂM. 30CM

REF

CROMADO CROMO CHROME

PRETO MATE NEGRO MATE BLACK MATT

NIQUEL ESCOVADO NIQUEL PULIDO BRUSHED NICKEL

Mezclador ducha c/ columna telescópico y ducha diam. 30cm
Shower mixer with telescopic column and shower diam. 30cm

5068051x

X = 2

X = 3

X = 0

499 €

844 €

844 €

6L/min 10L/min

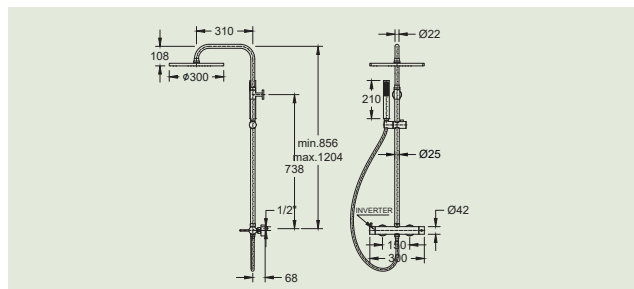

MISTURADORA DUCHE TERMOESTÁTICA C/ COLUNA TELESCÓPICA E CHUVEIRO DIÂM. 20CM

REF

CROMADO CROMO CHROME

PRETO MATE NEGRO MATE BLACK MATT

NIQUEL ESCOVADO NIQUEL PULIDO BRUSHED NICKEL

Mezclador ducha termostático c/ columna telescópico y ducha diam. 20cm
Thermostatic shower mixer with telescopic column and shower diam. 20cm

5068032x

X = 2

X = 3

X = 0

429 €

730 €

730 €

6L/min 10L/min

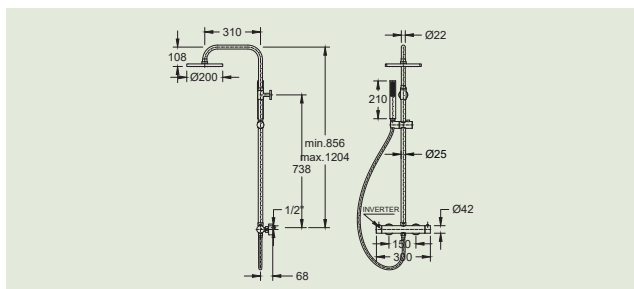

MISTURADORA DUCHE TERMOESTÁTICA C/ COLUNA TELESCÓPICA E CHUVEIRO DIÂM. 30CM REF CROMADO CROMO CHROME PRETO MATE NEGRO MATE BLACK MATT NIQUEL ESCOVADO NIQUEL PULIDO BRUSHED NICKEL

Mezclador ducha termostático c/ columna telescópica y ducha diam. 30cm
Thermostatic shower mixer with telescopic column and shower diam. 30cm

5068082x

X = 2	X = 3	X = 0
586 €	998 €	998 €

6L/min 10L/min

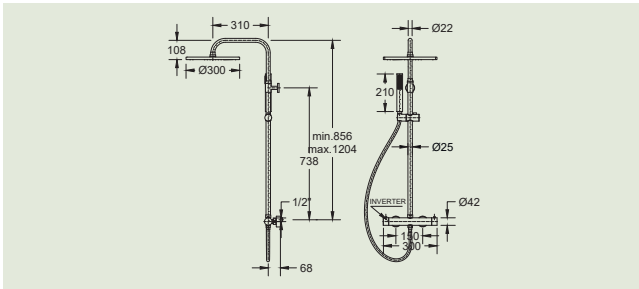

MISTURADORA DUCHE C/ COLUNA TELESCÓPICA E CHUVEIRO 20X20CM REF CROMADO CROMO CHROME PRETO MATE NEGRO MATE BLACK MATT NIQUEL ESCOVADO NIQUEL PULIDO BRUSHED NICKEL

Mezclador ducha c/ columna telescópica y ducha 20x20cm
Shower mixer with telescopic column and shower 20x20cm

5068061x

X = 2	X = 3	X = 0
492 €	832 €	832 €

6L/min 10L/min

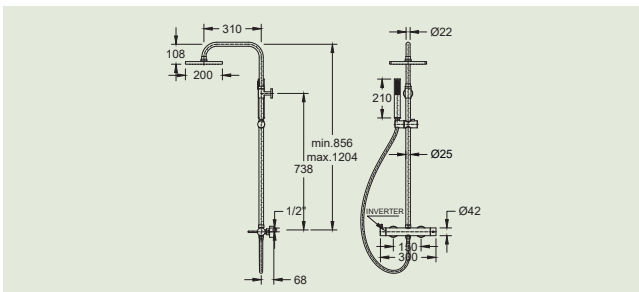

MISTURADORA DUCHE C/ COLUNA TELESCÓPICA E CHUVEIRO 30X30CM REF CROMADO CROMO CHROME PRETO MATE NEGRO MATE BLACK MATT NIQUEL ESCOVADO NIQUEL PULIDO BRUSHED NICKEL

Mezclador ducha c/ columna telescópica y ducha 30x30cm
Shower mixer with telescopic column and shower 30x30cm

5068071x

X = 2	X = 3	X = 0
560 €	952 €	952 €

6L/min 10L/min

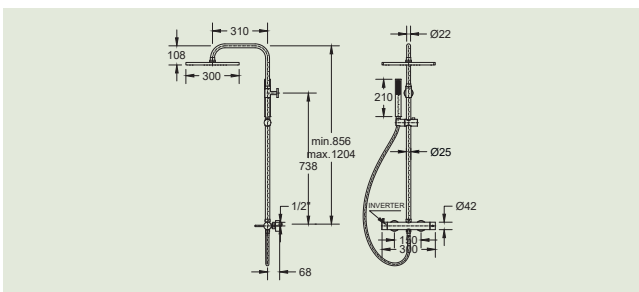

MISTURADORA DUCHE TERMOESTÁTICA C/ COLUNA TELESCÓPICA E CHUVEIRO 20X20CM

REF

CROMADO CROMO CHROME

PRETO MATE NEGRO MATE BLACK MATT

NIQUEL ESCOVADO NIQUEL PULIDO BRUSHED NICKEL

Mezclador ducha termostático c/ columna telescópico y ducha 20x20cm
Thermostatic shower mixer with telescopic column and shower 20x20cm

5068062x

X = 2

X = 3

X = 0

500 €

851 €

851 €

6L/min 10L/min

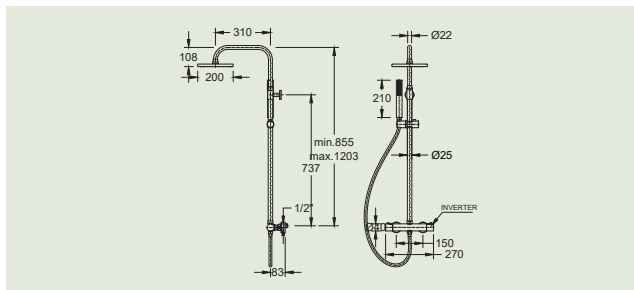

MISTURADORA DUCHE TERMOESTÁTICA C/ COLUNA TELESCÓPICA E CHUVEIRO 30X30CM

REF

CROMADO CROMO CHROME

PRETO MATE NEGRO MATE BLACK MATT

NIQUEL ESCOVADO NIQUEL PULIDO BRUSHED NICKEL

Mezclador ducha termostático c/ columna telescópico y ducha 30x30cm
Thermostatic shower mixer with telescopic column and shower 30x30cm

5068092x

X = 2

X = 3

X = 0

570 €

968 €

968 €

6L/min 10L/min

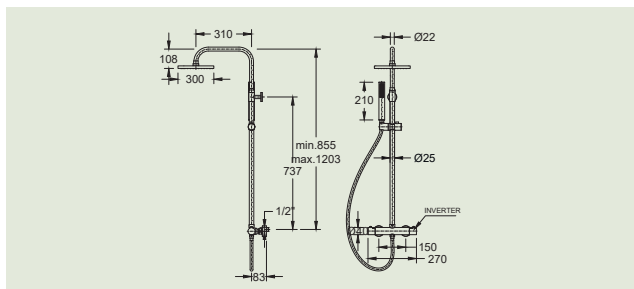

CHUVEIRO DIÂM. 20 CM ABS (10 L/MIN)

REF

CROMADO
CROMO
CRHOMEDucha diâm. 20 cm ABS (10 l/min.)
ABS shower diâm. 20cm (10 l/min)

50683082

38 €

CHUVEIRO DIÂM. 20 CM LATÃO (10 L/MIN)

REF

CROMADO
CROMO
CRHOMEPRETO MATE
NEGRO MATE
BLACK MATTNIQUEL ESCOVADO
NIQUEL PULIDO
BRUSHED NICKELDucha diâm. 20 cm laton (10 l/min.)
Brass shower diâm. 20cm (10 l/min)

5068311x

X = 2

119 €

X = 3

159 €

X = 0

159 €

CHUVEIRO DIÂM. 30 CM ABS (10 L/MIN)

REF

CROMADO
CROMO
CRHOMEDucha diâm. 30 cm ABS (10 l/min.)
ABS shower diâm. 30 cm (10 l/min)

50683102

119 €

CHUVEIRO DIÂM. 30 CM LATÃO (10 L/MIN)

REF

CROMADO
CROMO
CRHOMEPRETO MATE
NEGRO MATE
BLACK MATTNIQUEL ESCOVADO
NIQUEL PULIDO
BRUSHED NICKELDucha diâm. 30 cm laton (10 l/min.)
Brass shower diâm. 30 cm (10 l/min)

5068312x

X = 2

339 €

X = 3

406 €

X = 0

406 €

CHUVEIRO 20X20 CM ABS (10 L/MIN)

REF

CROMADO
CROMO
CRHOMEDucha 20x20 cm ABS (10 l/min.)
ABS shower 20x20 cm (10 l/min)

50683042

59 €

CHUVEIRO 20X20 CM LATÃO (10 L/MIN)

REF

CROMADO
CROMO
CRHOMEPRETO MATE
NEGRO MATE
BLACK MATTNIQUEL ESCOVADO
NIQUEL PULIDO
BRUSHED NICKELDucha 20x20 cm laton (10 l/min.)
Brass shower 20x20 cm (10 l/min)

5068313x

X = 2

152 €

X = 3

182 €

X = 0

182 €

CHUVEIRO 30X30 CM ABS (10 L/MIN)

REF

CROMADO
CROMO
CRHOMEDucha 30x30 cm ABS (10 l/min.)
ABS shower 30x30 cm (10 l/min)

50683062

147 €

CHUVEIRO 30X30 CM LATÃO (10 L/MIN)

REF

CROMADO
CROMO
CRHOMEPRETO MATE
NEGRO MATE
BLACK MATTNIQUEL ESCOVADO
NIQUEL PULIDO
BRUSHED NICKELDucha 30x30 cm laton (10 l/min.)
Brass shower 30x30 cm (10 l/min)

5068314x

X = 2

360 €

X = 3

432 €

X = 0

432 €

HASTE DE PAREDE 35 CM

REF

CROMADO
CROMO
CRHOMEPRETO MATE
NEGRO MATE
BLACK MATTNIQUEL ESCOVADO
NIQUEL PULIDO
BRUSHED NICKELBarra mural para ducha 35cm
Wall rod 35cm

5069723x

X = 2

42 €

X = 3

63 €

X = 0

63 €

HASTE VERTICAL 15 CM

REF

CROMADO
CROMO
CRHOMEPRETO MATE
NEGRO MATE
BLACK MATTNIQUEL ESCOVADO
NIQUEL PULIDO
BRUSHED NICKELBarra de techo 15cm
Ceilling rod 15cm

5069724x

X = 2

30 €

X = 3

45 €

X = 0

45 €

HASTE VERTICAL 30 CM

REF

CROMADO
CROMO
CRHOMEPRETO MATE
NEGRO MATE
BLACK MATTNIQUEL ESCOVADO
NIQUEL PULIDO
BRUSHED NICKELBarra de techo 30 cm
Ceilling rod 30 cm

5069726x

X = 2

43 €

X = 3

57 €

X = 0

57 €

RAMPA DE DUCHE CILÍNDRICA ABS

REF

CROMADO
CROMO
CRHOMERampa de ducha cilíndrica ABS
ABS cylindrical shower rail

50695082

53 €

CHUVEIRO DE PAREDE C/ HASTE

REF

CROMADO
CROMO
CRHOME

Ducha de pared
Wall mounted showerhead with stem

50649002

107 €

CHUVEIRO À PAREDE ANTI VANDALISMO

REF

CROMADO
CROMO
CRHOME

Ducha de pared antivandalismo
Wall mounted antivandalism shower

50609902

72 €

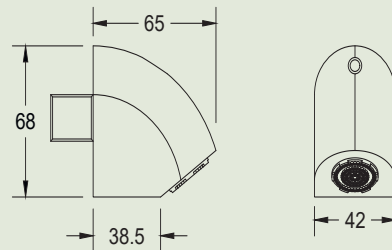

MISTURADORA SEMI ENCASTRADA C/ KIT HIGIÉNICO

REF

CROMADO
CROMO
CRHOME

PRETO MATE
NEGRO MATE
BLACK MATT

NIQUEL ESCOVADO
NIQUEL PULIDO
BRUSHED NICKEL

Mezclador semi empotrado
con kit de aseo
Single lever semi recessed mixer with
hygienic kit

5069100x

X = 2

X = 3

X = 0

182 €

273 €

273 €

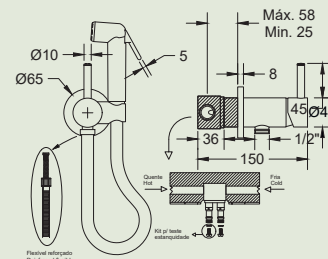

CHUVEIRO DE MÃO CILÍNDRICO EM ABS

REF

CROMADO
CROMO
CRHOME

PRETO MATE
NEGRO MATE
BLACK MATT

NIQUEL ESCOVADO
NIQUEL PULIDO
BRUSHED NICKEL

Ducha de mano cilíndrica en ABS
ABS Cilindric hand shower

5069701x

X = 2

X = 3

X = 0

25 €

45 €

45 €

BICHA FLEXÍVEL DUPLA GRAFATURA 150 CM

REF

CROMADO
CROMO
CRHOME

Manguera de ducha de
mano 150cm
Shower flexible hose 150cm

50617022

14 €

FLEXÍVEL PVC ANTI-TORSÃO 150 CM

REF

CROMADO
CROMO
CRHOME

PRETO MATE
NEGRO MATE
BLACK MATT

NIQUEL ESCOVADO
NIQUEL PULIDO
BRUSHED NICKEL

Manguera de ducha PVC
anti torsión 150cm
PVC anti torsion shower
flexible hose 150cm

5061704x

X = 2

X = 3

X = 0

18 €

26 €

26 €

TOMADA DE ÁGUA C/ SUPORTE DE CHUVEIRO MANUAL

REF

CROMADO
CROMO
CRHOME

PRETO MATE
NEGRO MATE
BLACK MATT

NIQUEL ESCOVADO
NIQUEL PULIDO
BRUSHED NICKEL

Conexión de agua con soporte de ducha
de mano
Water outlet w/ hand shower support

5517302x

X = 2

X = 3

X = 0

34 €

51 €

51 €

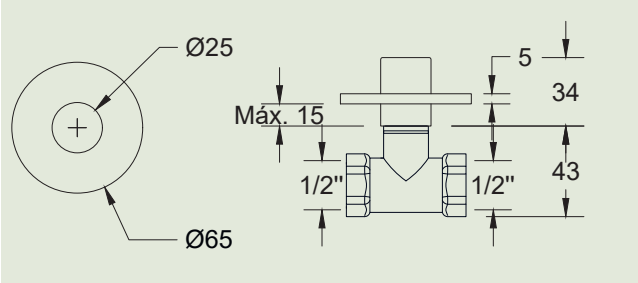
TORNEIRA DE PASSAGEM 1/2"		REF	CROMADO CROMO CRHOME	PRETO MATE NEGRO MATE BLACK MATT	NIQUEL ESCOVADO NIQUEL PULIDO BRUSHED NICKEL
Grifo de corte 1/2" Cutting tap 1/2"	5067911x	X = 2	X = 3	X = 0	
		28 €	40 €	40 €	
					

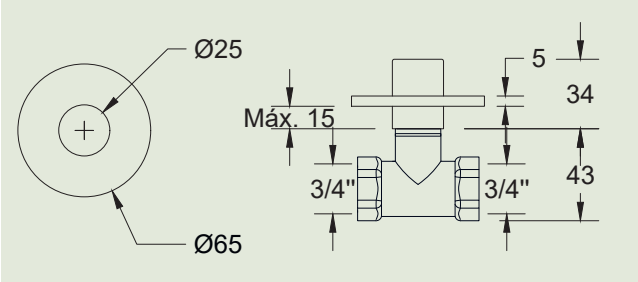

TORNEIRA DE PASSAGEM 3/4"		REF	CROMADO CROMO CRHOME	PRETO MATE NEGRO MATE BLACK MATT	NIQUEL ESCOVADO NIQUEL PULIDO BRUSHED NICKEL
Grifo de corte 3/4" Cutting tap 3/4"	5067912x	X = 2	X = 3	X = 0	
		30 €	45 €	45 €	
					

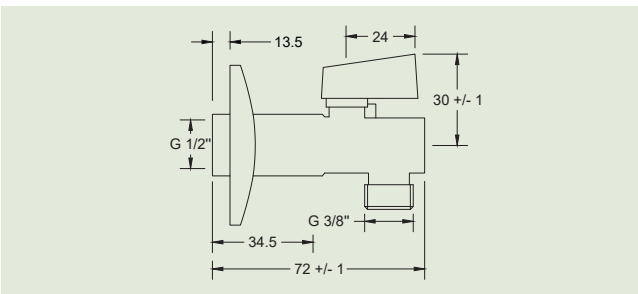
TORNEIRA DE ESQUADRIA 1/2" x 3/8" C/ FILTRO		REF	CROMADO CROMO CRHOME
Grifo de escuadra 1/2" x 3/8" con filtro Angle tap 1/2" x 3/8" w/ filter	50679042		
		8 €	
			

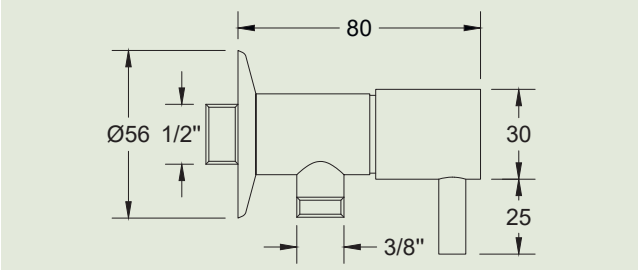

TORNEIRA DE ESQUADRIA 1/2" x 3/8"		REF	CROMADO CROMO CRHOME	PRETO MATE NEGRO MATE BLACK MATT	NIQUEL ESCOVADO NIQUEL PULIDO BRUSHED NICKEL
Grifo de escuadra 1/2" x 3/8" Angle tap 1/2" x 3/8"	5067906x	X = 2	X = 3	X = 0	
		35 €	49 €	49 €	
					





ESPAÇOS PÚBLICOS

ESPACIOS PÚBLICOS

PUBLIC SPACES



PMR 	190
URINÓIS URINARIOS URINALS	201
JÚNIOR	206
INFANTIL NIÑOS CHILDREN	209
PEÇAS TÉCNICAS PIEZAS TÉCNICAS TECHNICAL PIECES	210



PMR 

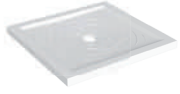

BASE DE CHUVEIRO AQUA
PLATO DE DUCHA AQUA
CERAMIC SHOWER TRAY AQUA
PAG 194



SANITA NORMAL
INODORO P/ TANQUE EMPOTRADO
WC CONCEALED
PAG 192



SANITA SUSPENSA
INODORO SUSPENDIDO
WALL HUNG WC
PAG 191



LAVATÓRIO GAIA
LAVABO GAIA
WASHBASIN GAIA
PAG 190



PMR TORNEIRAS
PMR GRIFOS
PMR TAPS
PAG 194



PMR APOIOS
PMR APOYOS
PMR ACCESSORIES
PAG 197



SANITA PMR CONFORT
INODORO P/ TANQUE BAJO
CLOSE COUPLED WC
PAG 193

URINÓIS | URINARIOS | URINALS



EGG
PAG 201



FACE
PAG 204



FLÓRIDA
PAG 201



KINO
PAG 203



NIAGARA
PAG 202



ORBITAL
PAG 201



SEPARADOR
SEPARATOR
PAG 204



CANTO
RINCÓN
CORNER
PAG 204

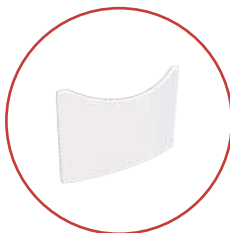

SPLASH GUARD
PAG 202

JÚNIOR



SANITA NORMAL
INODORO P/ TANQUE EMPOTRADO
WC CONCEALED
PAG 206



SANITA SUSPensa
INODORO SUSPENDIDO
WALL HUNG WC
PAG 207



LAVATÓRIO
LAVABO
WASHBASIN
PAG 206



INFANTIL | NIÑOS | CHILDREN



SANITA NORMAL
INODORO P/ TANQUE EMPOTRADO
WC CONCEALED
PAG 209



LAVATÓRIO
LAVABO
WASHBASIN
PAG 209



PEÇAS TÉCNICAS | PIEZAS TÉCNICAS | TECHNICAL PIECES



PIA SINTRA
PILA SINTRA
SINK SINTRA
PAG 210



PIA SILVES
PILA SILVES
SINK SILVES
PAG 210



PIA MONCHIQUE
PILA MONCHIQUE
SINK MONCHIQUE
PAG 210



PIA DE DESPEJO
PILA DE DESCARGA
DISCHARGE SINK
PAG 210



PIA HOSPITALAR
PILA VERTEDERO
MEDICAL SLOP HOOPER
PAG 211



LAVA-ROUPA MOZELA
LAVADERO MOZELA
WASHER MOZELA
PAG 211



MÓVEL LAVA-ROUPA MOZELA
MUEBLE LAVADERO MOZELA
FURNITURE FOR MOZELA WASHER
PAG 211



LAVATÓRIO GAIA

REF

BRANCO
BLANCO
WHITE

Lavabo Gaia
Washbasin Gaia
(62x55x20 cm)

78781002C

118 €

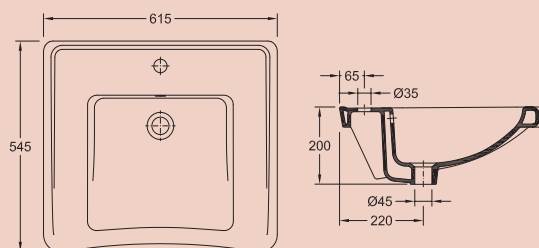

Suportes não incluídos | Soportes no incluidos | Supports not included

SUPOORTE FIXO

REF

AÇO INOX
ACERO INOXIDABLE
STAINLESS STEEL

Soporte fijo
Fixed support

55092000

114 €

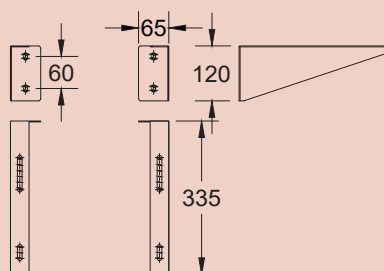

SUPOORTE REGULÁVEL

REF

AÇO INOX
ACERO INOXIDABLE
STAINLESS STEEL

Soporte regulable
Fixed support w/ pre-adjust

55089000

173 €

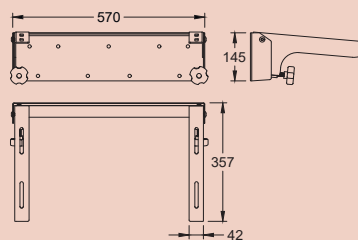

SUPOORTE BASCULANTE

REF

ACO INOX
ACERO INOXIDABLE
STAINLESS STEEL

Soporte basculante
Washbasin lift support

55025000

392 €

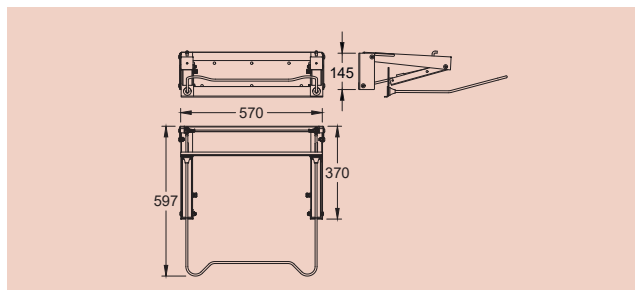

SANITA SUSPENSA PMR

REF

BRANCO
BLANCO
WHITE

Inodoro suspendido PMR
Wall hung WC PMR
(36x52x37 cm)

18003002K

104 €

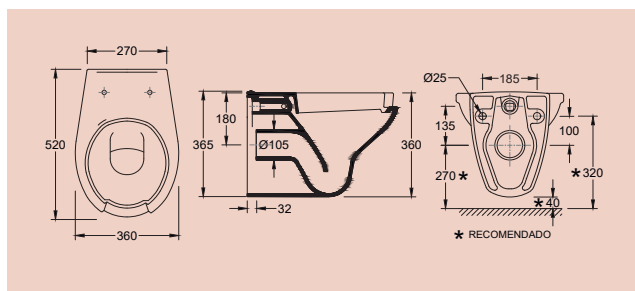

TAMPO CM

REF

BRANCO
BLANCO
WHITE

Tapa CM
Toilet seat CM

50261000

92 €



SANITA NORMAL V

REF

BRANCO
BLANCO
WHITEInodoro p/ tanque empotrado V
WC concealed V
(36x56x45 cm)

18063002K

165 €

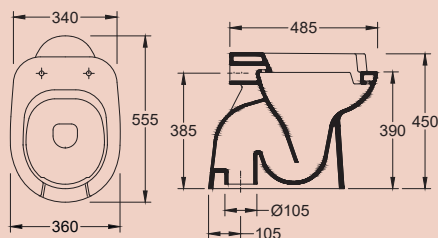
**KIT FIXAÇÃO N°3 (SANITA)**

REF

CROMADO
CROMO
CHROMEKit de fijación n°3 (inodoro)
Fixing kit n°3 (WC)

55007003

6 €

**TANQUE CERÂMICO
ENTRADA INFERIOR**

REF

BRANCO
BLANCO
WHITETanque cerâmico entrada inferior
Ceramic cistern bottom inlet

33182002

56 €

TAMPO CM

REF

BRANCO
BLANCO
WHITETapa CM
Toilet seat CM

50221000

92 €

**MECANISMO DD DESCARGA
ENTR. INFERIOR**

REF

BRANCO
BLANCO
WHITEMecanismo normal DD alimentação
inferior
Bottom inlet DD mechanism

55510041

61 €

**TANQUE PLÁSTICO EXTERIOR
ENTRADA LATERAL COM MECANISMO**

REF

BRANCO - CROMADO
BLANCO - CROMO
WHITE - CHROMETanque plástico exterior entrada lateral,
con mecanismo
Side inlet external cistern, w/ mechanism

55118010

29 €

TANQUE ENCASTRÁVEL DD INTRASLIM

REF

BRANCO - CROMADO
BLANCO - CROMO
WHITE - CHROMETanque empotrado DD intraslim
Concealed cistern with DD mechanism
intraslim

(51x46x9 cm)

55037091

108 €

SANITA PMR CONFORT

REF

BRANCO
BLANCO
WHITE

Inodoro p/ tanque baixo
Close coupled WC
(36x56x45 cm)

18083002K

196 €

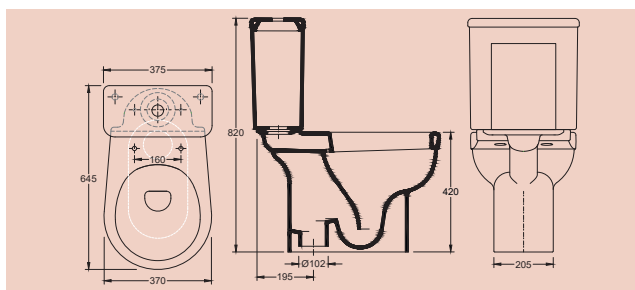

TANQUE ALIMENTAÇÃO INFERIOR C/ MECANISMO

REF

BRANCO
BLANCO
WHITE

Tanque alimentación inferior con mecanismo
Bottom inlet cistern with mechanism

19182002K

96 €

TANQUE ALIMENTAÇÃO LATERAL C/ MECANISMO

REF

BRANCO
BLANCO
WHITE

Tanque alimentación lateral con mecanismo
Side inlet cistern with mechanism

19181002K

96 €

TAMPO TERMODUR

REF

BRANCO
BLANCO
WHITE

Tapa termodur
Toilet seat

50340000

47 €

TAMPO CM

REF

BRANCO
BLANCO
WHITE

Tapa CM
Toilet seat CM

50330000

117 €



BASE DE CHUVEIRO AQUA

REF

BRANCO
BLANCO
WHITE

Plato de ducha Aqua
Ceramic shower tray Aqua
(90x90x5,5 cm)

78639002K

254 €

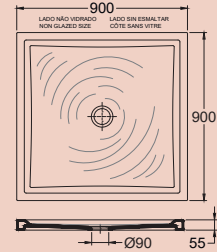
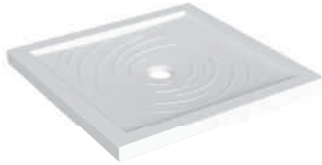

VÁLVULA DE DESCARGA DE DUCHE C/ SIFÃO

REF

BRANCO - CROMADO
BLANCO - CROMO
WHITE - CHROME

Válvula de descarga de ducha con sifon
Shower tray valve w/ siphon

55019010

37 €

MISTURADORA TEMPORIZADA P/ LAVATÓRIO

REF

CROMADO
CROMO
CHROME

Grifo mezclador temporizado p/ lavabo
Washbasin timer mixer

50682012

151 €

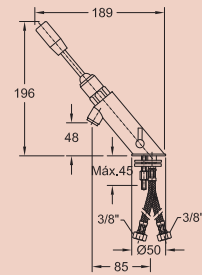

TORNEIRA TEMPORIZADA P/ LAVATÓRIO

REF

CROMADO
CROMO
CHROME

Grifo temporizado p/ lavabo
Washbasin timer tap

50667132

113 €

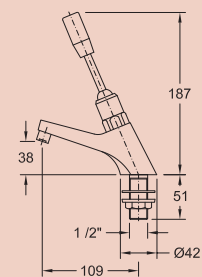

MONOCOMANDO DE LAVATÓRIO STYLE

REF

CROMADO CROMO CHROME

PRETO NEGRO BLACK

X = 2

X = 3

Monocomando p/ lavabo Style
Single lever washbasin mixer Style

5066302x

119 €

178 €

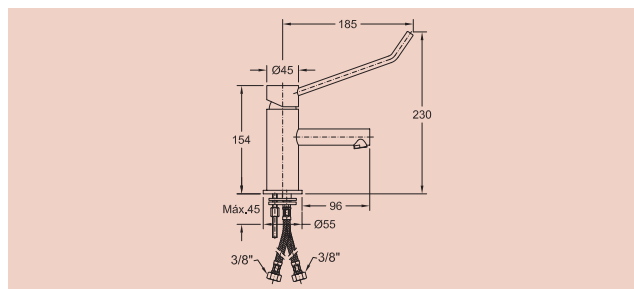

MONOCOMANDO DE BASE DE CHUVEIRO STYLE

REF

CROMADO CROMO CHROME

Monocomando p/ ducha Style
Single lever shower mixer Style

50663162

225 €

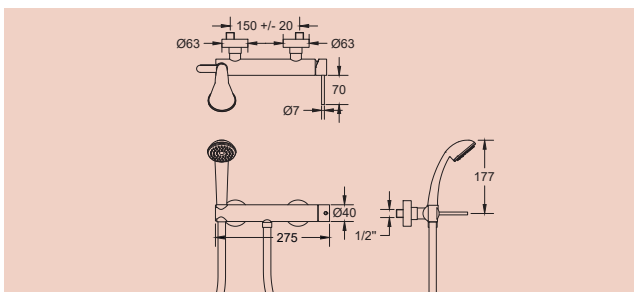

MONOCOMANDO DE LAVATÓRIO

REF

CROMADO CROMO CHROME

Monocomando p/ lavabo
Single lever washbasin mixer Style

50663000

78 €

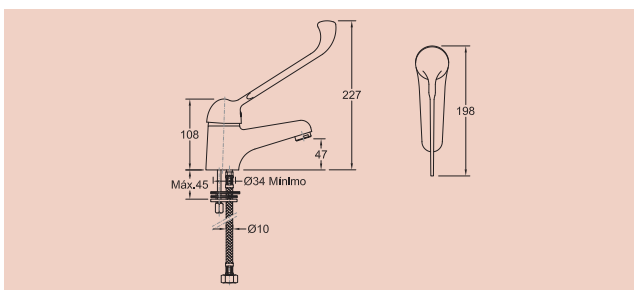

MONOCOMANDO C/ CHUVEIRO DE VÁLVULA

REF

CROMADO
CROMO
CHROME

Monocomando p/ ducha c/ pistola de presión
Single lever shower mixer w/ valve shower

50680012

112 €

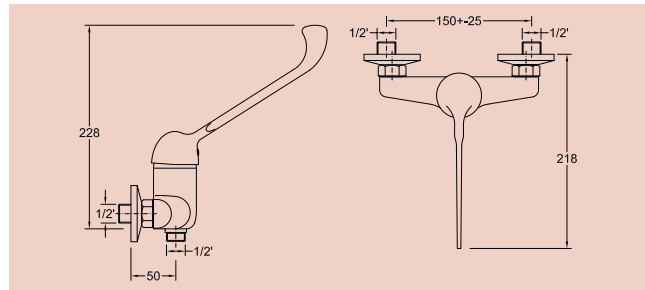

MONOCOMANDO DE DUCHE

REF

CROMADO
CROMO
CHROME

Monocomando p/ ducha
Single lever shower mixer

50680022

102 €

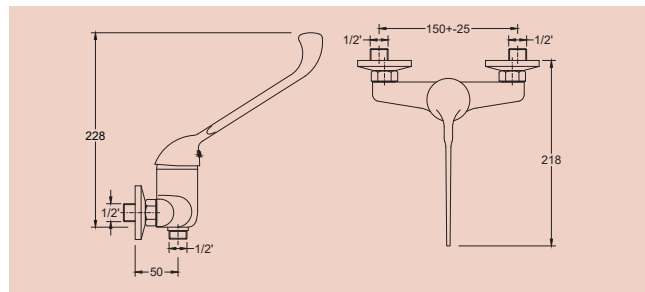

ESPELHO BASCULANTE (40x73 CM)

REF

INOX POLIDO
ACERO INOXIDABLE PULIDO
POLISHED STAINLESS STEEL

INOX ESCOVADO
ACERO CEPILLADO
BRUSHED STAINLESS STEEL

PRETO
NEGRO
BLACK

X=

0

8

3

Espejo basculante (40x73 cm)
Adjustable mirror (40x73 cm)

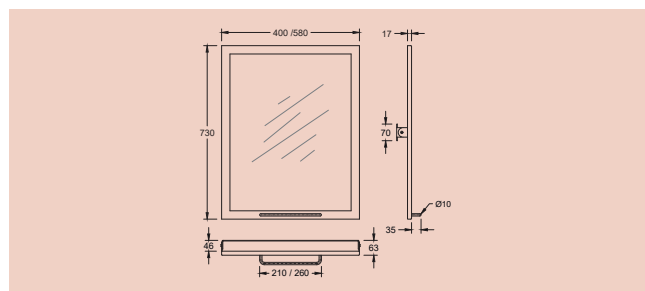

5098901x

276 €

276 €

414 €

ESPELHO BASCULANTE (58x73 CM)

Espejo basculante (58x73 cm)
Adjustable mirror (58x73 cm)

5098902x

294 €

294 €

441 €

**BANCO DE CHUVEIRO REBATÍVEL
C/ ASSENTO EM NYLON (35x30 CM)**

REF

INOX POLIDO
ACERO INOXIDABLE PULIDO
POLISHED STAINLESS STEEL

INOX ESCOVADO
ACERO CEPILLADO
BRUSHED STAINLESS STEEL

PRETO
NEGRO
BLACK

Asiento abatible de ducha en nylon
(35x30 cm)
Nylon folding shower seat (35x30 cm)

X= 0 8 3

5505901x

247 €

247 €

371 €

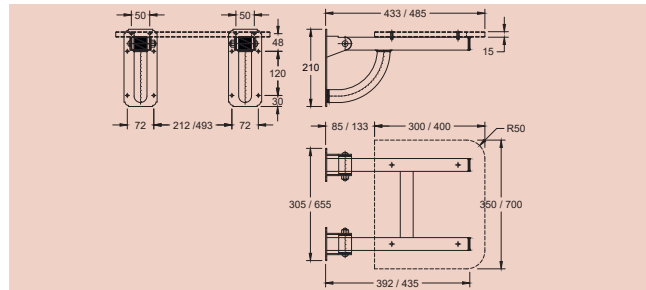

**BANCO DE CHUVEIRO REBATÍVEL
C/ ASSENTO EM NYLON (70x40 CM)**

Asiento abatible de ducha en nylon
(35x30 cm)
Nylon folding shower seat (35x30 cm)

5505902x

348 €

348 €

523 €

APOIO DIREITO P/ SANITA

REF

INOX POLIDO
ACERO INOXIDABLE PULIDO
POLISHED STAINLESS STEEL

INOX ESCOVADO
ACERO CEPILLADO
BRUSHED STAINLESS STEEL

PRETO
NEGRO
BLACK

Apoyo derecho para inodoro
WC support right

X= 0 8 3

5514009x

141 €

141 €

212 €

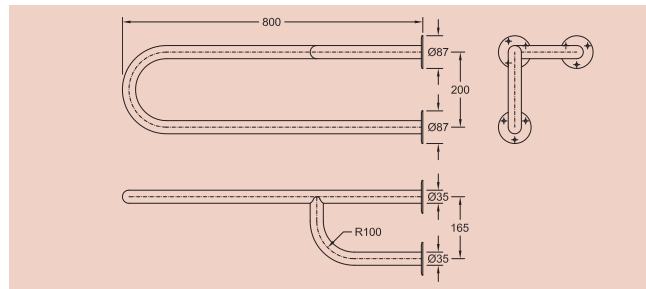

APOIO ESQUERDO P/ SANITA

Apoyo izquierdo para inodoro
WC support left

5514010x

141 €

141 €

212 €



APOIO BASCULANTE P/ SANITA C/ PORTA ROLO DIREITO

REF

INOX POLIDO
ACERO INOXIDABLE PULIDO
POLISHED STAINLESS STEEL

INOX ESCOVADO
ACERO CEPILLADO
BRUSHED STAINLESS STEEL

PRETO NEGRO
BLACK

X= 0 8 3

Apoyo basculante p/ inodoro con portarollos derecho
Adjustable WC support right w/ paper holder

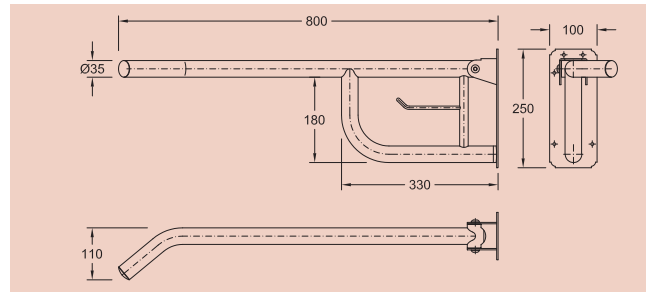

5514012x

180 €

180 €

270 €

APOIO BASCULANTE P/ SANITA DIREITO

Apoyo basculante p / inodoro derecho
Adjustable WC support right

5514002x

165 €

165 €

248 €

APOIO BASCULANTE P/ SANITA C/ PORTA ROLO ESQUERDO

Apoyo basculante p/ inodoro con portarollos izquierdo
Adjustable WC support left w/ paper holder

5514013x

180 €

180 €

270 €

APOIO BASCULANTE P/ SANITA ESQUERDO

Apoyo basculante p / inodoro izquierdo
Adjustable WC support left

5514003x

165 €

165 €

248 €

APOIO BASCULANTE P/ SANITA C/ PORTA ROLO

REF

INOX POLIDO
ACERO INOXIDABLE PULIDO
POLISHED STAINLESS STEEL

INOX ESCOVADO
ACERO CEPILLADO
BRUSHED STAINLESS STEEL

PRETO NEGRO
BLACK

X= 0 8 3

Apoyo basculante p/ inodoro con portarollos
Adjustable WC support w/ paper holder

5514014x

171 €

171 €

257 €

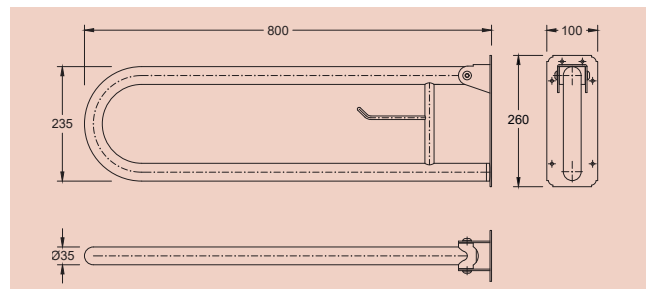

**PEDESTAL EXTERIOR DE
FIXAÇÃO AO CHÃO**

REF

INOX POLIDO
ACERO INOXIDABLE PULIDO
POLISHED STAINLESS STEEL

INOX ESCOVADO
ACERO CEPILLADO
BRUSHED STAINLESS STEEL

PRETO
NEGRO
BLACK

X= 0 8 3

Pedestal exterior para fijación al suelo
External floor standing pedestal

5514030x

225 €

225 €

251 €

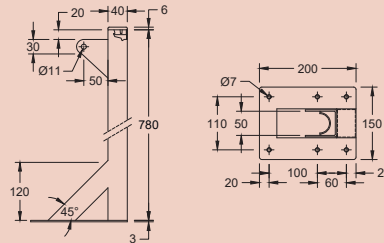

APOIO ARTICULADO 80 CM

REF

INOX POLIDO
ACERO INOXIDABLE PULIDO
POLISHED STAINLESS STEEL

INOX ESCOVADO
ACERO CEPILLADO
BRUSHED STAINLESS STEEL

PRETO
NEGRO
BLACK

X= 0 8 3

Apoyo articulado 80 cm
Articulated support 80 cm

5514011x

229 €

229 €

344 €

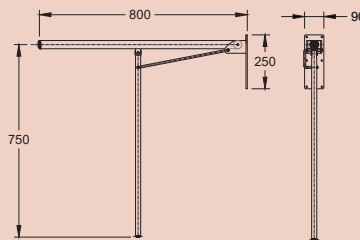

APOIO DIREITO P/ LAVATÓRIO

REF

INOX POLIDO
ACERO INOXIDABLE PULIDO
POLISHED STAINLESS STEEL

INOX ESCOVADO
ACERO CEPILLADO
BRUSHED STAINLESS STEEL

PRETO
NEGRO
BLACK

X= 0 8 3

Apoyo derecho para lavabo
Washbasin support right

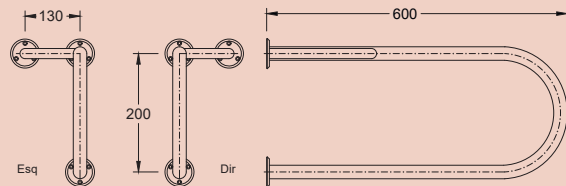

5514007x

120 €

120 €

180 €

APOIO ESQUERDO P/ LAVATÓRIO

Apoyo izquierdo para lavabo
Washbasin support left

5514008x

120 €

120 €

180 €

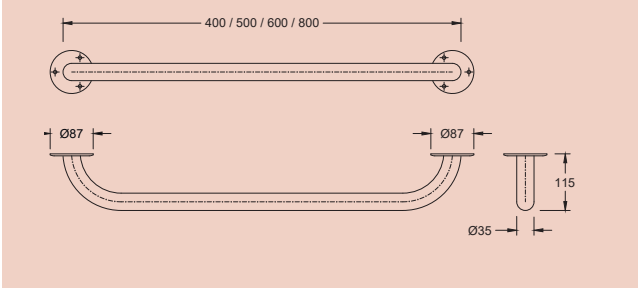

APOIO AÇO INOX 400 MM		REF	INOX POLIDO ACERO INOXIDABLE PULIDO POLISHED STAINLESS STEEL	INOX ESCOVADO ACERO CEPILLADO BRUSHED STAINLESS STEEL	PRETO NEGRO BLACK
			X= 0	8	3
Barra sencilla 400 mm Support w/ 400 mm					
		5514004x	66 €	66 €	99 €
APOIO AÇO INOX 500 MM					
Barra sencilla 500 mm Support w/ 500 mm		5514005x	69 €	69 €	104 €
APOIO AÇO INOX 600 MM					
Barra sencilla 600 mm Support w/ 600 mm		5514001x	72 €	72 €	108 €
APOIO AÇO INOX 800 MM					
Barra sencilla 800 mm Support w/ 800 mm		5514006x	78 €	78 €	117 €

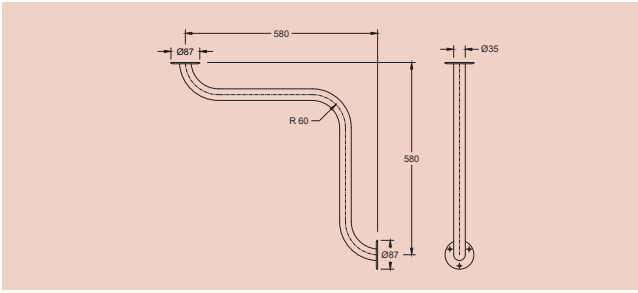
APOIO DE CANTO 600x600 MM		REF	INOX POLIDO ACERO INOXIDABLE PULIDO POLISHED STAINLESS STEEL	INOX ESCOVADO ACERO CEPILLADO BRUSHED STAINLESS STEEL	PRETO NEGRO BLACK
			X= 0	8	3
Apoyo angular 600x600 mm Horizontal corner support 600x600 mm					
		5514017x	120 €	120 €	180 €
APOIO VERTICAL DE CANTO 600x600 MM					
Apoyo vertical de rincon 600x600 mm Vertical corner support 600x600 mm		5514019x	129 €	129 €	194 €

FLÓRIDA (ALIM. TRAS.)	REF	BRANCO BLANCO WHITE	PRETO NEGRO BLACK
		XX= 00	48

Flórida (alim. tras.)
Florida (back inlet)

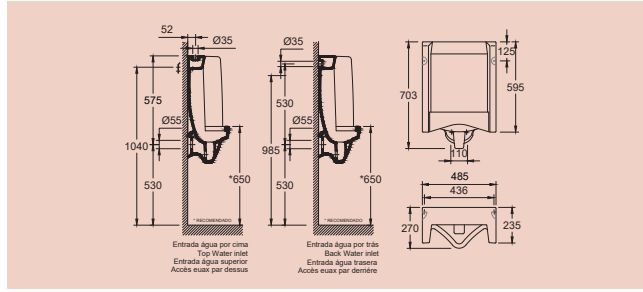

(49x27x70 cm)

18511xx2K

211 €

371 €

FLÓRIDA (ALIM. SUP.)

Flórida (alim. sup.)
Florida (top inlet)

(49x27x70 cm)

18510xx2K

211 €

371 €

ORBITAL	REF	BRANCO BLANCO WHITE	PRETO NEGRO BLACK
		XX= 00	48

(42x25x75 cm)

78560xx2K

332 €

580 €

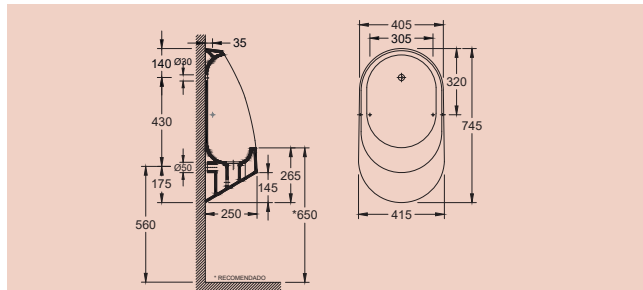

EGG	REF	BRANCO BLANCO WHITE	PRETO NEGRO BLACK
		XX= 00	48

(34x31x66 cm)

39530xx2K

230 €

403 €

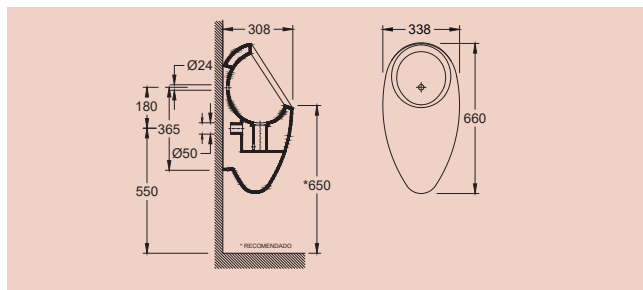

NIAGARA (ALIM. TRAS.)

REF

BRANCO
BLANCO
WHITE

PRETO
NEGRO
BLACK

XX= 00 48

Niagara (alim. tras.)
Niagara (back inlet)

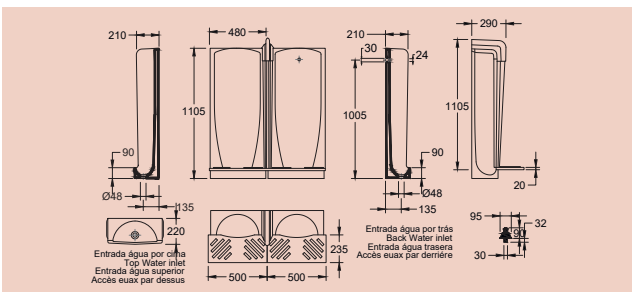

(48x22x110 cm)

18521xx2K

405 €

711 €

NIAGARA (ALIM. SUP.)

Niagara (alim. sup.)
Niagara (top inlet)

(48x22x110 cm)

18520xx2K

405 €

711 €

SPLASH GUARD

REF

BRANCO
BLANCO
WHITE

PRETO
NEGRO
BLACK

XX= 00 48

20940xx2K

86 €

151 €

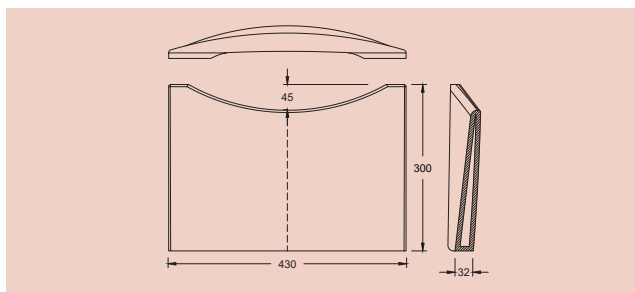

COBRE JUNTAS CURVO

REF

BRANCO
BLANCO
WHITE

PRETO
NEGRO
BLACK

XX= 00 48

Cubre juntas curvo
Curve joint cover

18923xx2

48 €

85 €

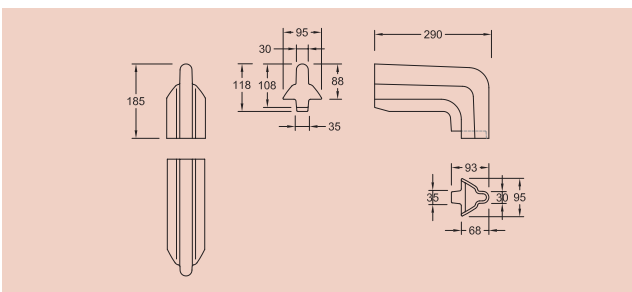



COBRE JUNTAS RECTO	REF	BRANCO BLANCO WHITE	PRETO NEGRO BLACK
		00	48

Cubre juntas recto
Straight joint cover

18922xx2

52 €

91 €

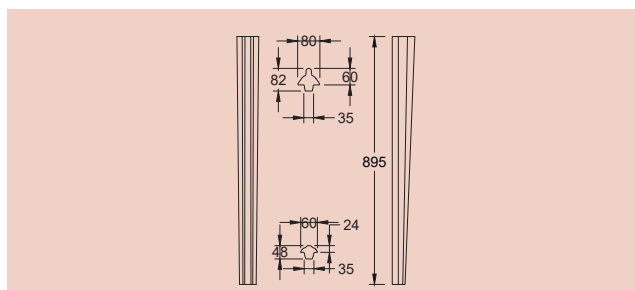

TERRAÇO URINOL	REF	BRANCO BLANCO WHITE	PRETO NEGRO BLACK
		00	48

Suelo p/ urinario
Urinal ceramic floor

18930xx2

63 €

109 €

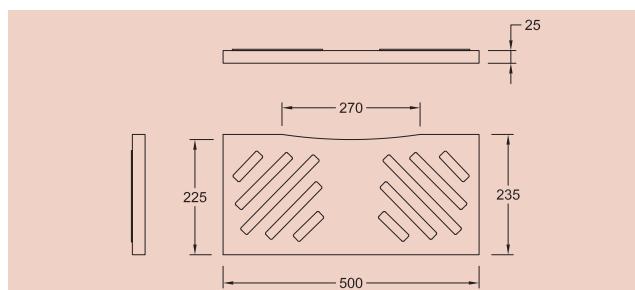

KINO	REF	BRANCO BLANCO WHITE	PRETO NEGRO BLACK
		00	48

(39x26x57 cm)

78530xx2K

255 €

447 €

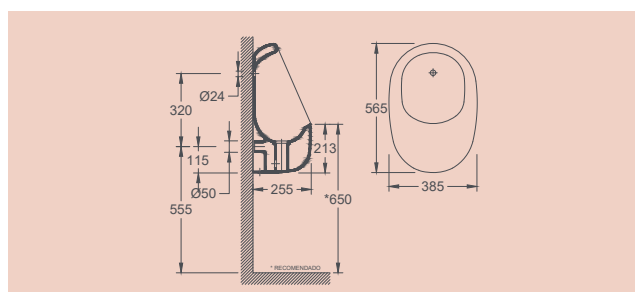

CANTO (ALIM. SUP.)

REF

BRANCO
BLANCO
WHITE

XX= 00

Rincón (alim. sup.)
Corner (top inlet)
(32x31x41 cm)

18550xx2K

173 €

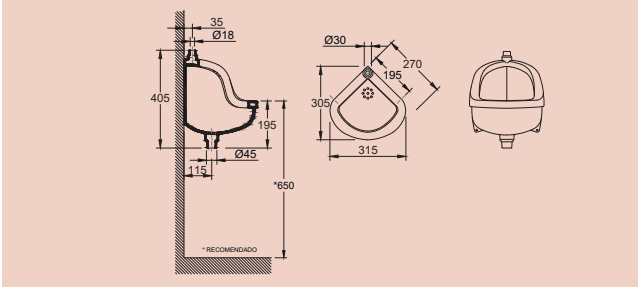

SEPARADOR CERÂMICO

REF

BRANCO
BLANCO
WHITE

PRETO
NEGRO
BLACK

XX= 00

48

Separador cerâmico
Ceramic separator
(35x6x70 cm)

78924xx2K

217 €

380 €

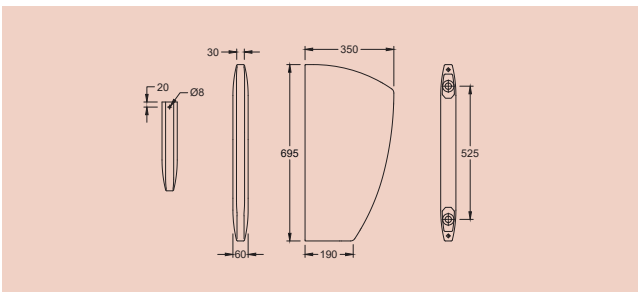

Complementos incluídos | Included complements

FACE (ALIM. TRAS.) S/ KIT

REF

BRANCO
BLANCO
WHITE

XX= 00

Face (alim. tras.) s/ kit
Face (back inlet) w/o kit

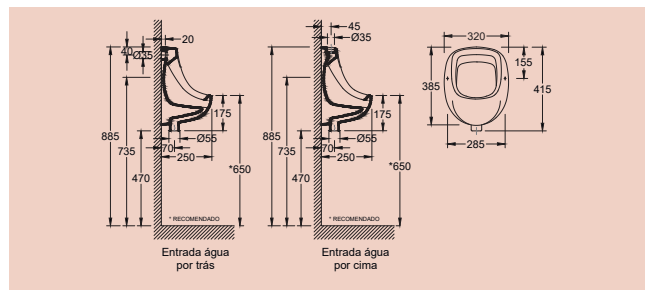

(32x25x42 cm)

18541xx2C

41 €

FACE (ALIM. SUP.) S/ KIT

Face (alim. sup.) s/ kit
Face (top inlet) w/o kit
(32x25x42 cm)

18540xx2C

41 €

KIT INSTALAÇÃO URINOL FLÓRIDA (ALIM. TRAS.)	REF		
Kit de instalación para urinario Florida (alim. tras.) Florida urinal installation kit (back inlet)	55011020		46 €
KIT INSTALAÇÃO URINOL FLÓRIDA (ALIM. SUP.)	REF		
Kit de instalación para urinario Florida (alim. sup.) Florida urinal installation kit (top inlet)	55011000		46 €
KIT INSTALAÇÃO URINOL ORBITAL	REF		
Kit de instalación para urinario Orbital Orbital urinal installation kit	55041041		59 €
KIT INSTALAÇÃO URINOL NIAGARA (ALIM. TRAS.)	REF		
Kit de instalación para urinario Niagara (alim. tras.) Niagara urinal installation kit (back inlet)	55013001		46 €
KIT INSTALAÇÃO URINOL NIAGARA (ALIM. SUP.)	REF		
Kit de instalación para urinario Niagara (alim. sup.) Niagara urinal installation kit (top inlet)	55013011		46 €
KIT INSTALAÇÃO URINÓIS EGG/ KINO	REF		
Kit de instalación para urinarios Egg / Kino Egg/ Kino urinals installation kit	55041061		59 €
KIT INSTALAÇÃO URINOL FACE (ALIM. TRAS.)	REF		
Kit de instalación para urinario de Face (alim. tras.) Face urinal installation kit (back inlet)	55012010		59 €
KIT INSTALAÇÃO URINOL FACE (ALIM. SUP.)	REF		
Kit de instalación para urinario de Face (alim. sup.) Face urinal installation kit (top inlet)	55012000		59 €
KIT INSTALAÇÃO URINOL DE CANTO (ALIM. SUP.)	REF		
Kit de instalación para urinario de rincon (alim. sup.) Corner urinal installation kit (top inlet)	55032000		56 €
KIT INSTALAÇÃO SEPARADOR CERÂMICO	REF		
Kit de instalación de separador de cerámico Ceramic separator installation kit	55150170		21 €



LAVATÓRIO

REF

BRANCO
BLANCO
WHITE

PRETO
NEGRO
BLACK

XX=

00

48

Lavabo
Washbasin
(36x36x61 cm)

18601xx2C

215 €

377 €

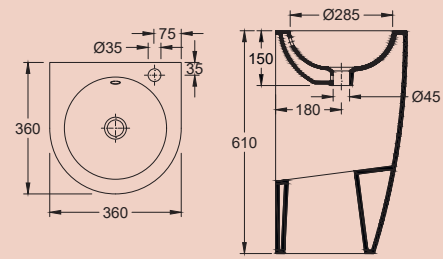

SANITA NORMAL V

REF

BRANCO
BLANCO
WHITE

PRETO
NEGRO
BLACK

XX=

00

48

Inodoro p/ tanque empotrado V
WC concealed V
(28x39x29 cm)

18651xx2KV

173 €

304 €

SANITA NORMAL H

Inodoro p/ tanque empotrado H
WC concealed H

(28x39x29 cm)

18651xx2KH

173 €

304 €

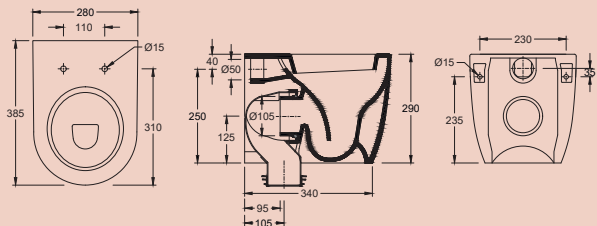



SANITA SUSPENSA **REF** BRANCO BLANCO WHITE PRETO NEGRO BLACK

Inodoro suspenso
Wall hung WC
(28x39x29 cm)

18651xx2KS

XX=

00

48

173 €

304 €

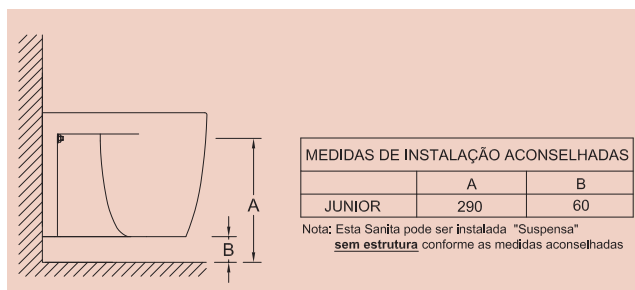

TAMPO CM **REF** BRANCO BLANCO WHITE CORES (TAMPÓS) COLORES (TAPAS) COLORS (TOILET SEATS)

Tapa CM
Toilet seat CM

50259xx0

XX=

00

51 / 52 / 53 / 54

79 €

89 €

Cores dos tampos | Colores de las tapas | Toilet seat colors

- 00 - branco | blanco | white
- 51 - amarelo | amarillo | yellow
- 52 - vermelho | rojo | red
- 53 - azul celeste | azul celeste | light blue
- 54 - rosa | rosa | pink

KIT FIXAÇÃO

REF

Kit de fijación
Fixing kit

55007003

6 €

KIT FIXAÇÃO (SANITA SUSPENSA)

REF

Kit de fijación (inodoro suspendido)
Fixing kit (wall hung WC)

55007005

14 €

CURVA DE DESCARGA VERTICAL

REF

Curva de descarga vertical
Vertical discharge curve

55104041

21 €

**TUBO DE DESCARGA HORIZONTAL
25CM**

REF

Tubo de descarga horizontal 25cm
Horizontal discharge tube 25cm

55040010

21 €



LAVATÓRIO

REF

BRANCO
BLANCO
WHITE

Lavabo
Washbasin

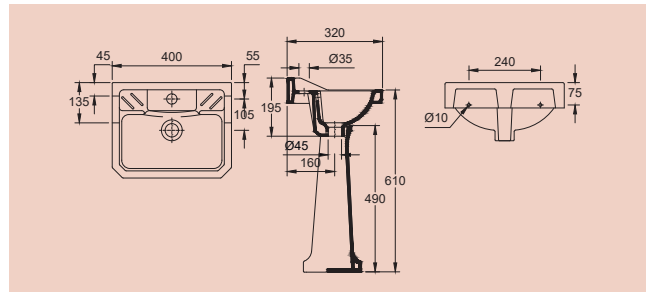

(40x32x20 cm)

16371002C

108 €

COLUNA

Columna
Pedestal

16230002K

79 €

SANITA NORMAL V

REF

BRANCO
BLANCO
WHITE

Inodoro p/ tanque empotrado V
WC concealed V

(27x35x29 cm)

18650002K

115 €

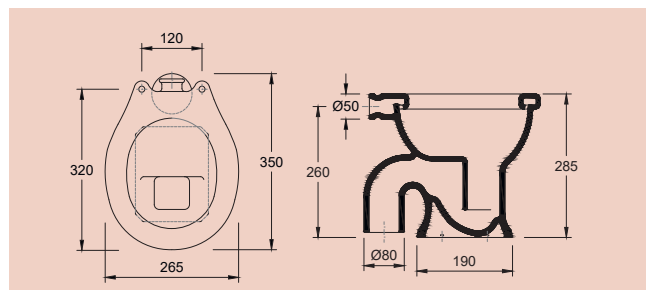

TAMPO CM

REF

BRANCO
BLANCO
WHITE

CORES (TAMPÓS)
COLORES (TAPAS)
COLORS (TOILET SEATS)

Tapa CM
Toilet seat CM

50308xx0

79 €

89 €

Cores dos tampos | Colores de las tapas | Toilet seat colors

- 00 - branco | blanco | white
- 51 - amarelo | amarillo | yellow
- 52 - vermelho | rojo | red
- 53 - azul celeste | azul celeste | light blue
- 54 - rosa | rosa | pink

KIT FIXAÇÃO Nº3 (LAVATÓRIO E SANITA)

REF

Kit de fijación nº3 (lavabo y inodoro)
Fixing kit nº3 (washbasin and WC)

55007003

6 €

PIA SINTRA

REF

BRANCO
BLANCO
WHITE

Pila Sintra
Sink Sintra
(48x38x19 cm)

78615002C

162 €

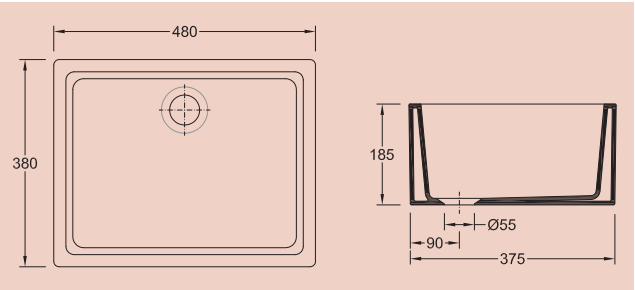

PIA SILVES

REF

BRANCO
BLANCO
WHITE

Pila Silves
Sink Silves
(51x40x19 cm)

78616002C

118 €

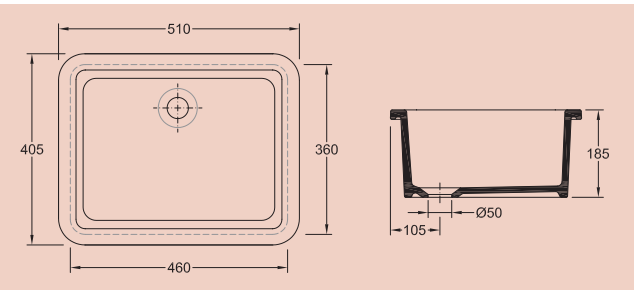

PIA MONCHIQUE

REF

BRANCO
BLANCO
WHITE

Pila Monchique
Sink Monchique
(46x46x27 cm)

78618002C

204 €

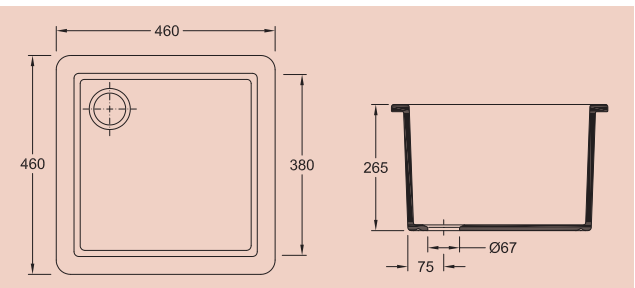

PIA DE DESPEJO

REF

BRANCO
BLANCO
WHITE

Pila de descarga
Discharge sink
(32x32x22 cm)

18614002C

58 €

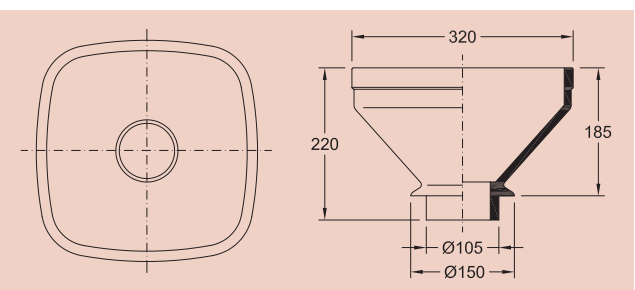

PIA HOSPITALAR

REF

BRANCO
BLANCO
WHITE

Pila vertedero
Medical slop hooper

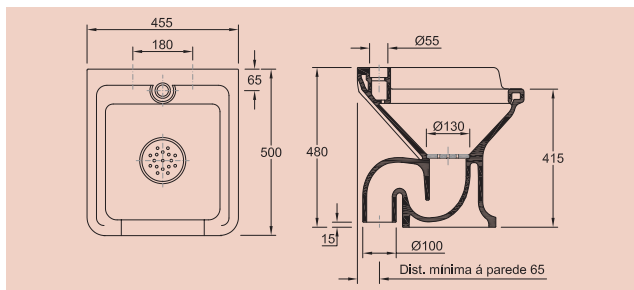

(46x50x48 cm)

18613002K

233 €

GRADE INOX

Rejilla cromada para vertedero
Stainless steel grid

55003001

124 €

LAVA-ROUPA MOZELA

REF

BRANCO
BLANCO
WHITE

Lavadero Mozela
Washer Mozela



78660002C

118 €

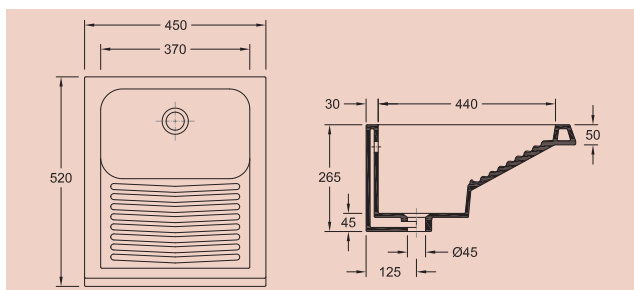

MÓVEL P/ LAVA-ROUPA MOZELA (KIT)

REF

BRANCO
BLANCO
WHITE

Mueble p/ lavadero Mozela (kit)
Furniture for Mozela washer (kit)

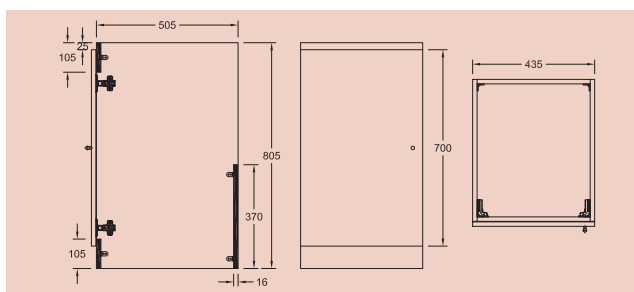

(44x51x81 cm)

55332010

132 €

KIT FIXAÇÃO Nº3

Kit de fijación nº3
Fixing kit nº3

55007003

6 €





BASES DE CHUVEIRO

PLATOS DE DUCHA
SHOWER TRAYS

CERÂMICAS 216
EN CERÁMICA
CERAMIC

EM RESINA COM CARGA MINERAL 219
EN RESINA CON CARGA MINERAL
RESIN WITH MINERAL CHARGE



CERÂMICAS | EN CERÁMICA | CERAMIC



EGG
PAG 216

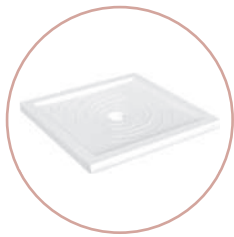

AQUA
PAG 216

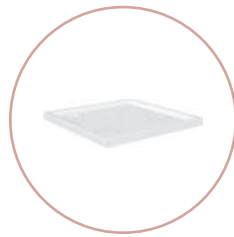

DOURO PLUS
PAG 216



LUCA
PAG 216



BERNA
PAG 217



PÁDUA
PAG 217

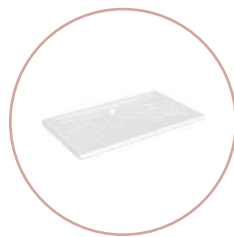

ARIS
PAG 217

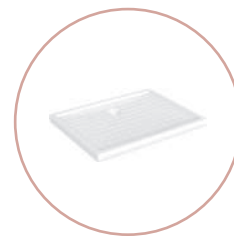

LUSA
PAG 218

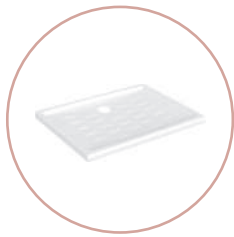

DANILO
PAG 218

CERÂMICA ANTIDERRAPANTE EM HIGHPOR

Revestimiento cerámico antideslizante
Non-slip ceramic coating



FLOW
PAG 218

CERÂMICA ANTIDERRAPANTE EM HIGHPOR

Revestimiento cerámico antideslizante
Non-slip ceramic coating



Resistência às manchas

Resistencia a las manchas

Stain resistance

Base 100% cerâmica e reciclável .
Fácil escoamento e instalação.

HighPor ® : Revestimento
Cerâmico antiderrapante - Classe C



Fácil limpeza

Fácil limpieza

Easy cleaning

Plato de ducha 100% cerâmica y reciclable.
Excelente flujo y facilidad de instalación.

HighPor ®: Revestimento cerâmico
antideslizante - Clase C



Resistência ao fogo

Resistente al fuego

Fire resistance

100% ceramic and recyclable shower tray.
Excellent flow and ease of installation.

HighPor ®: Non-slip ceramic coating - Class C



Resistência ao ataque químico

Resistencia al ataque químico

Resistance to chemical attack

IKO SLATE



IKO SLATE
PAG 219

As bases de chuveiro em resina são fornecidas com válvula slim incluída
Los platos de ducha de resina se suministran con válvula slim incluida
The resin shower trays are supplied with slim valve included

Fabricadas com resinas de poliéster insaturadas tipo isoftálica neo pentil glicol.
Superfície em Gelcoat sanitário, ligada por termofusão ao corpo da base.
Fabricadas con resinas de poliéster insaturadas tipo isoftálica neo pentil glicol.
Superfície en Gelcoat sanitario, ligada por termofusión al cuerpo de la base.
Made with unsaturated polyester resins isophthalic type neo pentil glycol. Surface
in Sanitary Gelcoat, bonded by thermofusion to the body of the base.

- Principais características:
- Absorção de água de 0,1%
 - Excelentes propriedades mecânicas
 - Excelente resistência ao desgaste
 - Excelente resistência à degradação provocada pela humidade
 - Excelente resistência à acção dos solventes (acetona, diluentes, etc.)
 - Antiderrapante
 - Antibacteriano
- Uniformidade total de cor, permitindo cortes em dimensões não standard sem alteração do aspecto.
- Incluem válvula Slim
 - Garantia de 3 anos contra defeitos de fabrico

- Principales características:
- Absorción de agua del 0,1%
 - Excelentes propiedades mecánicas
 - Excelente resistencia al desgaste
 - Excelente resistencia a la degradación provocada por la humedad
 - Excelente resistencia a la acción de los solventes (acetona, diluyentes, etc.)
 - Antiderrapante
 - Antibacteriano
- Uniformidad total de color, permitiendo cortes en dimensiones no estándar sin alteración del aspecto.
- Incluyen la válvula delgado
 - Garantía de 3 años contra defectos de fabricación

- Main features:
- Water absorption of 0.1%
 - Excellent mechanical properties
 - Excellent wear resistance
 - Excellent resistance to degradation caused by humidity
 - Excellent resistance to solvents (acetone, thinners, etc.)
 - Non-slip
 - Antibacterial
- Full uniformity of color, allowing cuts in non-standard dimensions without changing the appearance.
- Include Slim Valve
 - 3 year warranty against manufacturing defects



EGG

REF

BRANCO
BLANCO
WHITE

(90x90x5 cm)

39673002K

419 €

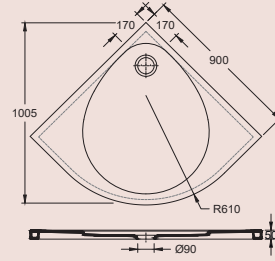

AQUA

REF

BRANCO
BLANCO
WHITE

(90x90x5,5 cm)

78639002K

254 €

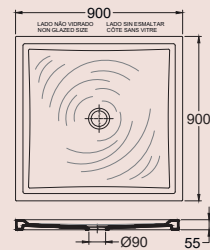

DOURO PLUS

REF

BRANCO
BLANCO
WHITE

(80x80x5 cm)

78670002K

185 €

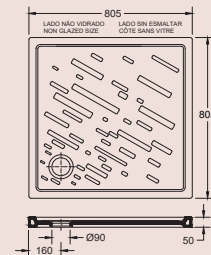

LUCA

REF

BRANCO
BLANCO
WHITE

(140x80x5 cm)

78672002K

450 €

(140x70x5 cm)

78671002K

393 €

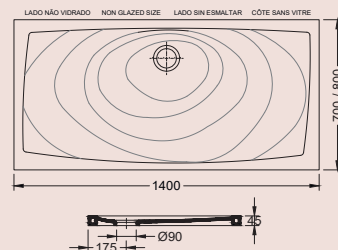

BERNA	REF	BRANCO BLANCO WHITE
--------------	------------	------------------------------------

(130x80x4 cm)

78674002K

434 €

(130x75x4 cm)

78673002K

394 €

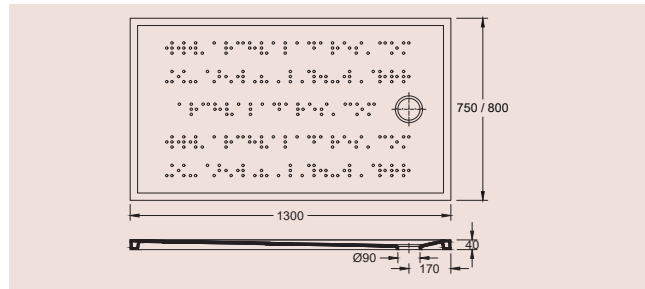

PÁDUA	REF	BRANCO BLANCO WHITE
--------------	------------	------------------------------------

(120x80x5 cm)

78636002K

299 €

(100x80x5 cm)

78635002K

254 €

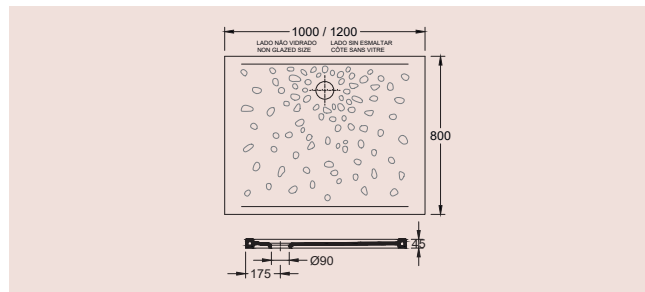

ARIS	REF	BRANCO BLANCO WHITE
-------------	------------	------------------------------------

(120x70x4 cm)

78634002K

266 €

(100x70x4 cm)

78633002K

219 €

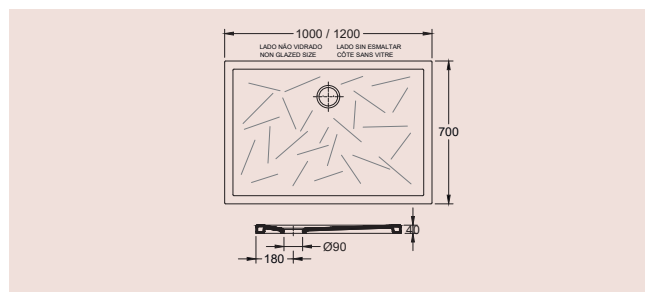

LUSA

REF

BRANCO
BLANCO
WHITE

(90x70x6 cm)

78632002K

185 €

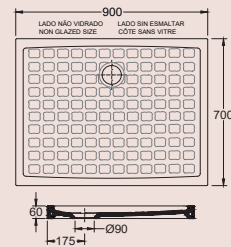

DANILO

REF

BRANCO
BLANCO
WHITE

(90x70x5 cm)

78631002K

174 €

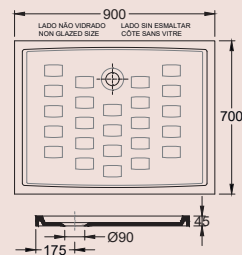

FLOW

REF

CORES ESPECIAIS
COLORES ESPECIALES
SPECIAL COLORS

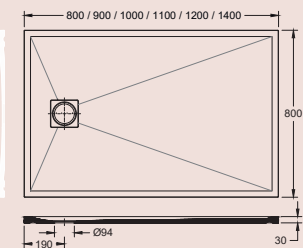

140x80 (140x80x3 cm)

78686102K

511 €

120x80 (120x80x3 cm)

78684102K

393 €

110x80 (110x80x3 cm)

78683102K

353 €

100x80 (100x80x3 cm)

78682102K

313 €

90x80 (90x80x3 cm)

78681102K

273 €

80x80 (80x80x3 cm)

78680102K

246 €

As bases de chuveiro em cerâmica são fornecidas com válvula slim incluída
Los platos de ducha de cerámica se suministran con válvula slim incluida
The ceramic shower trays are supplied with slim valve included

IKO SLATE

REF

CORES ESPECIAIS
COLORES ESPECIALES
SPECIAL COLORS

REF

CORES ESPECIAIS
COLORES ESPECIALES
SPECIAL COLORS

XX= 00 / 24 / 31 / 47 / 48

XX= 00 / 24 / 31 / 47 / 48

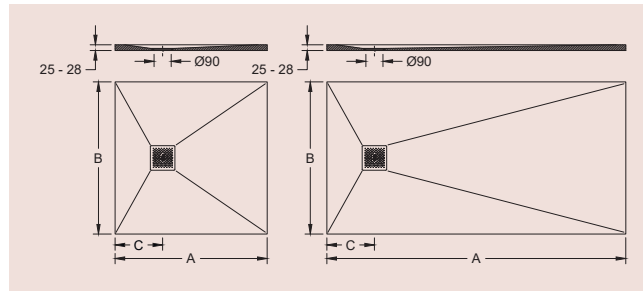

CORES . COLORES . COLORS

xx = 00 RAL 9003	BRANCO . BLANCO . WHITE
xx = 24 RAL 7004	CINZA . GRIS . GREY
xx = 31 RAL 1013	AREIA . ARENA . SAND
xx = 47 RAL 7026	ARDÓSIA . PIZARRA . SLATE
xx = 48 RAL 9005	PRETO . NEGRO . BLACK

A tabela seguinte apresenta as distâncias do centro da válvula ao topo mais próximo.
La siguiente tabla muestra las distancias desde el centro de la válvula hasta la parte superior más cercana.
The following table shows the distances from the valve center to the nearest top.

		Comprimento . Longitud . Length (cm) - A															Espessura . Grosor . Thickness (cm) 2,5 - 2,8
		70	80	90	100	110	120	130	140	150	160	170	180	190	200	210	
Largura . Ancho . Width (cm) - B	70	35	35	35	35	45	45	45	45	45	45	45	45	45	45	45	45
	75	-	35	35	35	45	45	45	45	45	45	45	45	45	45	45	45
	80	-	40	35	35	45	45	45	45	45	45	45	45	45	45	45	45
	90	-	-	35	35	45	45	45	45	45	45	45	45	45	45	45	45
	100	-	-	-	35	45	45	45	45	45	45	45	45	45	45	45	45
120	-	-	-	-	-	45	45	45	45	45	45	45	45	45	45	45	

Distância lateral ao centro da válvula . Distancia lateral al centro de la válvula .
Lateral distance to the center of the valve (cm) - C (+/- 2% tolerância . tolerancia . tolerance)

120x120x3 cm	52504xx5	555 €
100x100x3 cm	52502xx5	368 €
90x90x3 cm	52501xx5	314 €
80x80x3 cm	52500xx5	249 €
70x70x3 cm	52505xx5	207 €
215x120x3 cm	52406xx5	972 €
215x100x3 cm	52405xx5	807 €
215x90x3 cm	52404xx5	728 €
215x80x3 cm	52403xx5	610 €
215x75x3 cm	52402xx5	609 €
215x70x3 cm	52401xx5	535 €
210x120x3 cm	52593xx5	886 €
210x100x3 cm	52562xx5	726 €
210x90x3 cm	52561xx5	654 €
210x80x3 cm	52560xx5	582 €
210x75x3 cm	52591xx5	579 €
210x70x3 cm	52590xx5	510 €
200x120x3 cm	52589xx5	848 €
200x100x3 cm	52559xx5	688 €
200x90x3 cm	52558xx5	623 €
200x80x3 cm	52557xx5	548 €
200x75x3 cm	52587xx5	546 €
200x70x3 cm	52586xx5	485 €

190x120x3 cm	52585xx5	833 €
190x100x3 cm	52556xx5	657 €
190x90x3 cm	52555xx5	595 €
190x80x3 cm	52554xx5	529 €
190x75x3 cm	52553xx5	523 €
190x70x3 cm	52552xx5	460 €
180x120x3 cm	52583xx5	751 €
180x100x3 cm	52570xx5	620 €
180x90x3 cm	52569xx5	563 €
180x80x3 cm	52568xx5	498 €
180x75x3 cm	52567xx5	494 €
180x70x3 cm	52566xx5	439 €
170x120x3 cm	52581xx5	734 €
170x100x3 cm	52599xx5	585 €
170x90x3 cm	52550xx5	529 €
170x80x3 cm	52549xx5	473 €
170x75x3 cm	52548xx5	470 €
170x70x3 cm	52547xx5	417 €
160x120x3 cm	52579xx5	685 €
160x100x3 cm	52546xx5	557 €
160x90x3 cm	52545xx5	498 €
160x80x3 cm	52544xx5	448 €



IKO SLATE

REF

CORES ESPECIAIS
COLORES ESPECIALES
SPECIAL COLORS

REF

CORES ESPECIAIS
COLORES ESPECIALES
SPECIAL COLORS

XX= 00 / 24 / 31 / 47 / 48

XX= 00 / 24 / 31 / 47 / 48

160x75x3 cm 52543xx5 444 €

160x70x3 cm 52542xx5 389 €

150x120x3 cm 52577xx5 670 €

150x100x3 cm 52541xx5 520 €

150x90x3 cm 52540xx5 467 €

150x80x3 cm 52539xx5 417 €

150x75x3 cm 52538xx5 414 €

150x70x3 cm 52537xx5 370 €

140x120x3 cm 52575xx5 627 €

140x100x3 cm 52536xx5 485 €

140x90x3 cm 52535xx5 439 €

140x80x3 cm 52534xx5 389 €

140x75x3 cm 52533xx5 384 €

140x70x3 cm 52532xx5 352 €

130x120x3 cm 52573xx5 604 €

130x100x3 cm 52531xx5 463 €

130x90x3 cm 52530xx5 426 €

130x80x3 cm 52529xx5 374 €

130x75x3 cm 52528xx5 381 €

130x70x3 cm 52527xx5 345 €

120x100x3 cm 52526xx5 417 €

120x90x3 cm 52525xx5 379 €

120x80x3 cm 52524xx5 339 €

120x75x3 cm 52523xx5 338 €

120x70x3 cm 52522xx5 301 €

110x100x3 cm 52521xx5 408 €

110x90x3 cm 52520xx5 368 €

110x80x3 cm 52519xx5 332 €

110x75x3 cm 52518xx5 309 €

110x70x3 cm 52517xx5 292 €

100x90x3 cm 52516xx5 335 €

100x80x3 cm 52515xx5 302 €

100x75x3 cm 52514xx5 289 €

100x70x3 cm 52513xx5 269 €

90x80x3 cm 52512xx5 276 €

90x75x3 cm 52511xx5 263 €

90x70x3 cm 52510xx5 250 €

80x75x3 cm 52506xx5 233 €

80x70x3 cm 52507xx5 224 €

Válvula | Valve 55019020 29 €

Grelha | Grid 55019030 21 €

As bases de chuveiro em resina são fornecidas de série com válvula Slim e grelha de escoamento
 Los platos de ducha de resina se suministran de serie con válvula Slim y rejilla de desagüe
 The resin shower trays are supplied as standard with a Slim valve and drain grate







BANHEIRAS

BAÑERAS
BATHTUBS

EGG	226
ZEN	226
LIGHT	226
LUX	226
STAR	227
CLASSIC	227
ARTIC	228
BALTIC	228



FREESTANDING



EGG
PAG 226



ZEN
PAG 226



LIGHT
PAG 226



LUX
PAG 226



STAR
PAG 227



CLASSIC
PAG 227

ACRÍLICAS | ACRÍLICO | ACRYLIC



ARTIC
PAG 228



BALTIC
PAG 228



EGG

REF

BRANCO
BLANCO
WHITE

(170x70x50 cm)

52100000

6.174 €

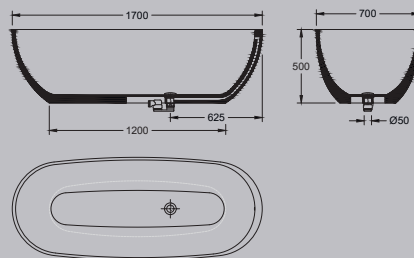

ZEN

REF

BRANCO
BLANCO
WHITE

(190x100x53 cm)

51100204

5.273 €

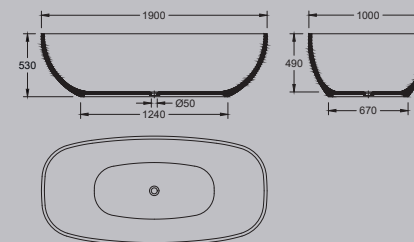

LIGHT

REF

BRANCO
BLANCO
WHITE

(155x75x55 cm)

51200004

3.200 €

(175x75x55 cm)

51200005

4.100 €

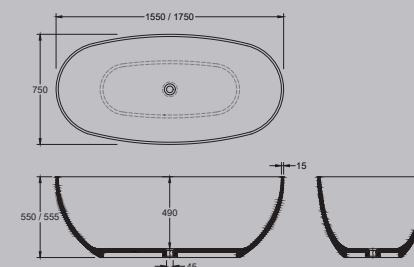

LUX

REF

BRANCO
BLANCO
WHITE

(165x70x58 cm)

51100202

4.675 €

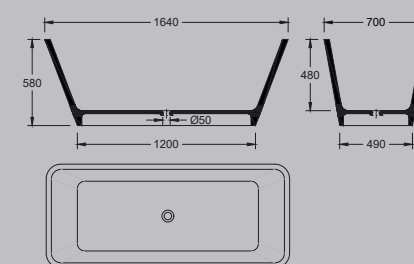

STAR

REF

BRANCO
BLANCO
WHITE

(178x84x63cm)

51100201

5.092 €

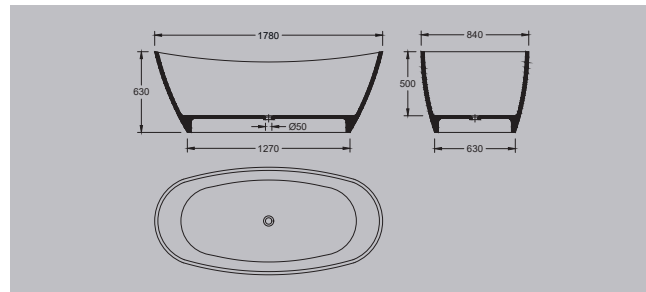

CLASSIC

REF

BRANCO
BLANCO
WHITE

(168x76x65 cm)

51100001

3.974 €

(175x82x55 cm)

51100002

4.400 €

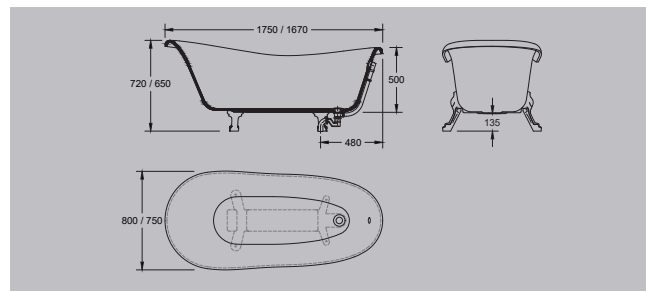

Banheiras Classic fornecidas com pés e sistema de esgoto cromados.
Bañeras Classic suministradas con pies y sistema de alcantarillado cromo.
Classic bathtubs supplied with chrome feet and sewage system.



ARTIC

REF

BRANCO
BLANCO
WHITE

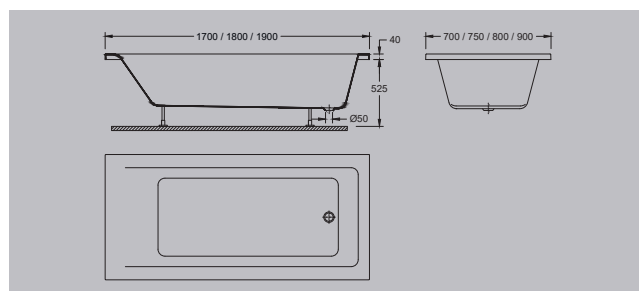

190x90	51614000	763 €
180x80	51613000	519 €
170x75	51612000	422 €
170x70	51611000	406 €

BALTIC

REF

BRANCO
BLANCO
WHITE

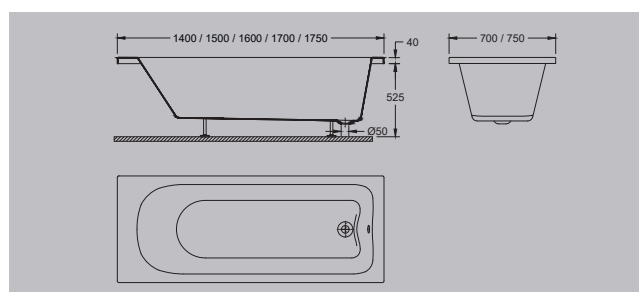

175x70	51627000	312 €
170x75	51626000	312 €
170x70	51625000	300 €
160x75	51624000	300 €
160x70	51623000	288 €
150x70	51622000	288 €
140x70	51621000	288 €

CHASSI

REF

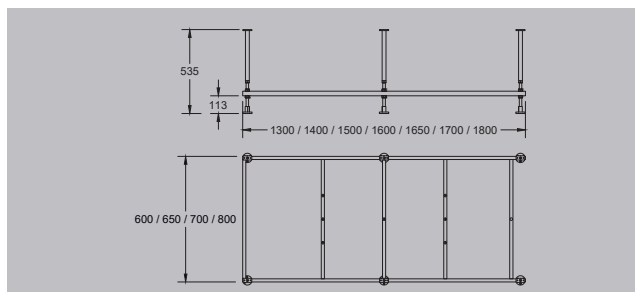
**PARA BANHEIRA 190x90**Para bañera 190x90
For bathtub 190x90

(1800x800x534mm)

55570009

145 €

PARA BANHEIRA 180x80Para bañera 180x80
For bathtub 180x80

(1700x700x534mm)

55570008

123 €

PARA BANHEIRA 175x70Para bañera 175x70
For bathtub 175x70

(1650x600x534mm)

55570007

110 €

PARA BANHEIRA 170x75Para bañera 170x75
For bathtub 170x75

(1600x650x534mm)

55570006

115 €

PARA BANHEIRA 170x70Para bañera 170x70
For bathtub 170x70

(1600x600x534mm)

55570005

102 €

PARA BANHEIRA 160x75Para bañera 160x75
For bathtub 160x75

(1500x650x534mm)

55570004

102 €

PARA BANHEIRA 160x70Para bañera 160x70
For bathtub 160x70

(1500x600x534mm)

55570003

96 €

PARA BANHEIRA 150x70Para bañera 150x70
For bathtub 150x70

(1400x600x534mm)

55570002

92 €

PARA BANHEIRA 140x70Para bañera 140x70
For bathtub 140x70

(1300x600x534mm)

55570001

84 €



CONJUNTO PÉS

REF

Juego de pies
Feet set

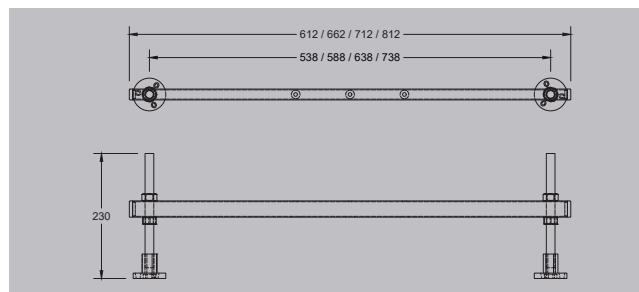

PARA BANHEIRA 90CM

Para bañera ancho 90cm
For bathtub width 90cm
(812x230mm)

55560004

46 €

PARA BANHEIRA 80CM

Para bañera ancho 80cm
For bathtub width 80cm
(712x230mm)

55560003

38 €

PARA BANHEIRA 75CM

Para bañera ancho 75cm
For bathtub width 75cm
(662x230mm)

55560002

31 €

PARA BANHEIRA 70CM

Para bañera ancho 70cm
For bathtub width 70cm
(612x230mm)

55560001

31 €

PAINEIS	REF	BRANCO BLANCO WHITE
----------------	------------	---------------------------

Paneles
Panels

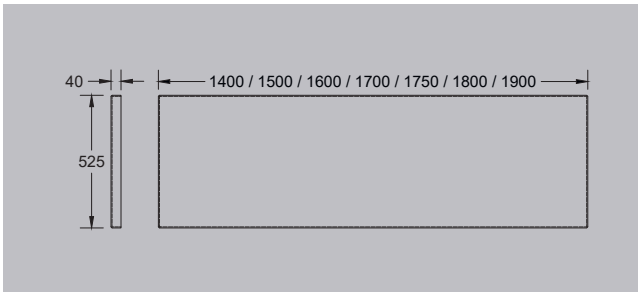

FRONTAL

Frontal
Frontal

190	51727000	231 €
180	51726000	191 €
175	51725000	191 €
170	51724000	170 €
160	51723000	170 €
150	51722000	151 €
140	51721000	151 €

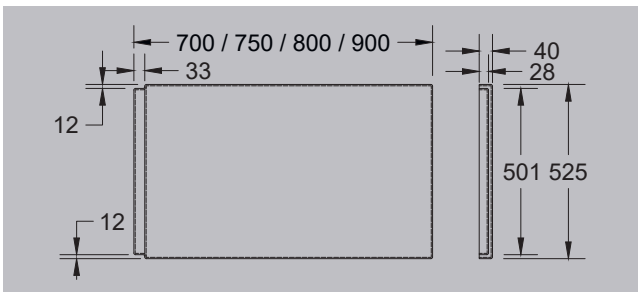

LATERAL

Lateral
Lateral

90	51714000	135 €
80	51713000	132 €
75	51712000	103 €
70	51711000	99 €





RESGUARDOS

MAMPARAS
SHOWER CABINS

OPALA	236
RUBI	237
PURA	238
SPLASH	239
EGG	241

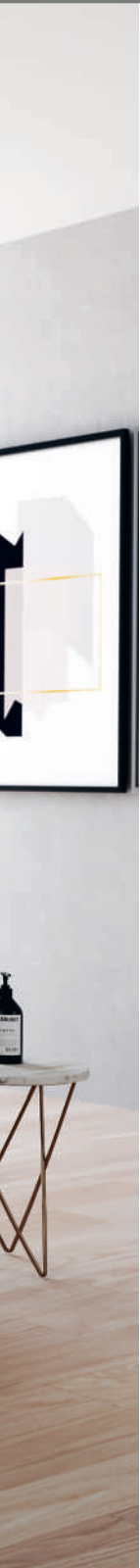



OPALA

Frontal com porta de correr e painel fixo. Produzido em vidro temperado de 8mm (porta de correr) e de 10mm (folha fixa) UNE-EN 12150-2. Altura de 1950mm. Componentes em aço inox. Calha de retenção inferior. Fecho magnético. Este painel permite montagem como painel frontal e como painel de canto, ligando com os painéis fixos até 800mm.



Frontal con puerta corredera y panel fijo. Producido en vidrio templado de 8 mm (puerta corredera) y 10 mm (hoja fija) UNE-EN 12150-2. Altura de 1950 mm. Componentes de acero inoxidable. Riel de retención inferior. Cierre magnético. Este panel permite el montaje como panel frontal y como panel de esquina, conectando con paneles fijos de hasta 800 mm.



Front with sliding door and fixed panel. Produced in tempered glass of 8mm (sliding door) and 10mm (fixed leaf) UNE-EN 12150-2. 1950mm height. Stainless steel components. Lower retaining rail. Magnetic closure. This panel allows assembly as a front panel and as a corner panel, connecting with fixed panels up to 800mm.



RUBI



Frontal com duas folhas articuladas. Produzido em vidro temperado de 6mm UNE-EN 12150-2. Altura de 1950mm. Perfis em alumínio. Puxador e acessórios cromados. Dobradiças em aço inox. Fecho magnético. Este painel permite montagem como painel frontal e como painel de canto, ligando com o painel fixo até 800mm.

Frontal con dos hojas abisagradas. Realizado en vidrio templado de 6 mm UNE-EN 12150-2. 1950 mm de altura. Perfil-les de aluminio. Tirador y accesorios cromados. Bisagras de acero inoxidable. Cierre magnético. Este panel permite el montaje como panel frontal y como panel de esquina, conectando con el panel fijo hasta 800 mm.

Front with two hinged leaves. Produced in 6mm tempered glass UNE-EN 12150-2. 1950mm height. Aluminum profile-les. Chrome handle and accessories. Stainless steel hinges. Magnetic closure. This panel allows assembly as a front panel and as a corner panel, connecting with the fixed panel up to 800mm.



PURA



Painel em vidro temperado de 8mm de espessura e 2000mm de altura com perfis em alumínio cromado brilho e extensor de suporte em aço inox. Vidro com tratamento anticalcário (easy cleaning).

Panel de vidrio templado de 8 mm de espesor y 2000mm de altura con perfiles de aluminio cromado brillante y extensor de soporte de acero inoxidable. Vidrio con tratamiento antical (fácil limpieza).



High tempered glass panel with 8mm thick and 2000mm and with gloss chrome aluminium profiles and stainless steel support extender. Glass with anti-calc treatment (easy cleaning).



SPLASH FRONTAL | SPLASH FRONT PANEL

Frontal com um painel fixo e uma porta de correr. Produzidos com perfis de alumínio cromado brilhante e vidro temperado de 6mm de espessura e 2000mm de altura. Vidro com tratamento anticalcário (easy cleaning).

Frontal con panel fijo y puerta corredera. Fabricado con perfiles de aluminio cromado brillante y cristal templado de 6 mm de espesor y 2000mm de altura. Vidrio con tratamiento antical (fácil limpieza).

Front with a fixed panel and a sliding door. Produced with profiles of shiny chrome aluminum and tempered glass 6mm thick and 2000mm high. Glass with anti-calc treatment (easy cleaning).

SPLASH MÓDULOS | SPLASH MODULES

Cabine de canto com painéis fixos e portas de correr de abertura central. Produzidas com perfis de alumínio cromado brilhante e vidro temperado de 6mm de espessura e 2000mm de altura. Vidro com tratamento anticalcário (easy cleaning)

Mampara de esquina con paneles fijos y puertas correderas con apertura central. Fabricado con perfiles de aluminio cromado brillante y vidrio templado de 6 mm de espesor y 2000mm de altura. Vidrio con tratamiento antical (fácil limpieza)

Corner cabin with fixed panels and sliding doors with central opening. Produced with profiles of shiny chrome aluminum and tempered glass 6mm thick and 2000mm high. Glass with anti-calc treatment (easy cleaning)



PAINEL FRONTAL C/ PORTA DE CORRER REF

Panel frontal con puerta corredera
Front panel with sliding door

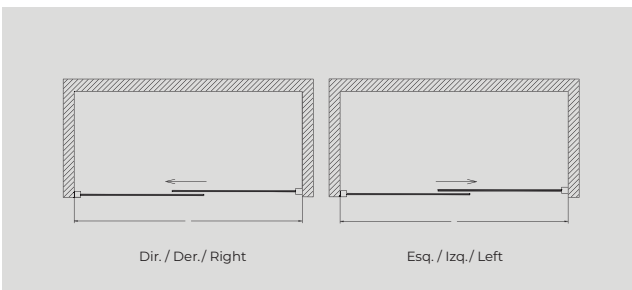

1401-1600 DIR./ESQ.

1401-1600 dir./izq.
1401-1600 right/left

52762072D
52762072E

1.651 €

1201-1400 DIR./ESQ.

1201-1400 dir./izq.
1201-1400 right/left

52762062D
52762062E

1.542 €

1000-1200 DIR./ESQ.

1000-1200 dir./izq.
1000-1200 right/left

52762052D
52762052E

1.433 €

PAINEL FRONTAL C/ PORTA DE CORRER E LATERAL ATÉ 800 REF

Panel frontal con puerta corredera y lateral hasta 800
Front panel with sliding door and side panel up to 800

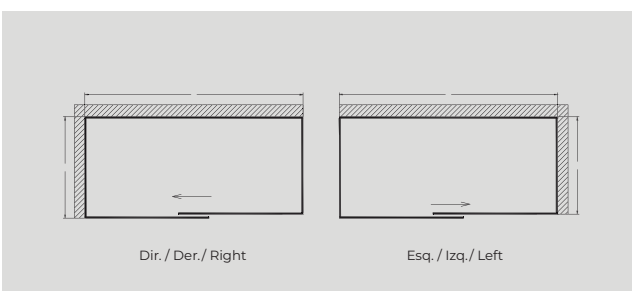

1401-1600x800 DIR./ESQ.

1401-1600x800 dir./izq.
1401-1600x800 right/left

52762102D
52762102E

2.207 €

1201-1400x800 DIR./ESQ.

1201-1400x80 dir./izq.
1201-1400x80 right/left

52762092D
52762092E

2.100 €

1000-1200x800 DIR./ESQ.

1000-1200x800 dir./izq.
1000-1200x800 right/left

52762082D
52762082E

1.991 €

PAINEL FRONTAL COM 2 FOLHAS ARTICULADAS

REF

Panel frontal con 2 hojas con bisagras
Front panel with 2 hinged sheets

**801-1000 DIR./ESQ.**

801-1000 dir./izq.
801-1000 right/left

52762022D
52762022E

1.155 €

640-800 DIR./ESQ.

640-800 dir./izq.
640-800 right/left

52762012D
52762012E

1.094 €

PAINEL FRONTAL COM 2 FOLHAS ARTICULADAS E LATERAL ATÉ 800MM

REF

Panel frontal con 2 hojas con bisagras y lateral hasta 800mm
Front panel with 2 hinged sheets and a side panel up to 800mm

**801-1000x800 DIR./ESQ.**

801-1000x800 dir./izq.
801-1000x800 right/left

52762042D
52762042E

1.606 €

640-800x800 DIR./ESQ.

640-800x800 dir./izq.
640-800x800 right/left

52762032D
52762032E

1.524 €



PURA

REF



PAINEL 120

Panel 120
Panel 120

52763232

387 €

PAINEL 100

Panel 100
Panel 100

52763222

351 €

PAINEL 90

Panel 90
Panel 90

52763212

333 €

PAINEL 80

Panel 80
Panel 80

52763202

306 €

PAINEL FRONTAL**REF**Panel frontal
Front panel

160	52763162	612 €
150	52763152	594 €
140	52763142	576 €
130	52763132	558 €
120	52763122	540 €
110	52763112	522 €
100	52763102	504 €

PAINEL LATERAL FIXO**REF**Panel lateral fijo
Fixed side panel

90	52763192	306 €
80	52763182	288 €
70	52763172	279 €



SPLASH MÓDULOS

REF

Splash módulos
Splash modules



120 (118,5 - 120)	52763052	376 €
100 (98,5 - 100)	52763042	344 €
90 (88,5 - 90)	52763032	334 €
80 (78,5 - 80)	52763022	312 €
75 (73,5 - 75)	52763012	306 €
70 (68,5 - 70)	52763002	296 €

Dimensão do resguardo	Dimensión de la mampara	Cabine dimension	Módulos/ Modules
	120x120		52763052 + 52763052
	120x70		52763052 + 52763002
	100x100		52763042 + 52763042
	100x70		52763042 + 52763002
	90x90		52763032 + 52763032
	90x70		52763032 + 52763002
	80x80		52763022 + 52763022
	80x70		52763022 + 52763002
	75x75		52763012 + 52763012
	70x70		52763002 + 52763002

Dimensão do resguardo	Dimensión de la mampara	Cabine dimension	Módulos/ Modules
	120x80		52763052 + 52763022
	120x75		52763052+ 52763012
	100x80		52763042 + 52763022
	100x75		52763042 + 52763012
	90x80		52763032 + 52763022
	90x75		52763032 + 52763012
	80x75		52763022 + 52763012

RESGUARDO EGG 90

REF

Mampara EGG 90
Shower cabin EGG 90

52750201

856 €



Resguardo com dois painéis fixos e duas portas de correr. Produzidos com perfis de alumínio metalizado e vidro temperado de 4mm. Rolamentos de esferas em inox. Altura de 185 cm

Mampara con dos paneles fijos y dos puertas correderas. Fabricado con perfiles de aluminio metalizado y vidrio templado de 4 mm. Rodamientos de bolas de acero inoxidable. Altura 185 cm

Cabin with two fixed panels and two sliding doors. Produced with metallized aluminum profiles and 4mm tempered glass. Stainless steel ball bearings. Height 185 cm





ACESSÓRIOS CERÂMICOS

ACCESORIOS EN CERÁMICA
CERAMIC ACCESSORIES

BLEND	246
NEOCLÁSSICO	248
ALFA	250



BLEND



CABIDE
PERCHA
HANGER
PAG 246



PORTA PIAÇABA
ESCOBILLERO
TOILET BRUSH HOLDER
PAG 246



PORTA-ROLO
PORTARROLLO
TOILET PAPER HOLDER
PAG 246

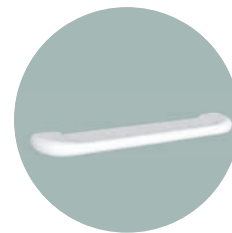

PRATELEIRA
ESTANTE
SHELF
PAG 247



VASSOURA
ESCOBILLA
BRUSH
PAG 246



SABONETEIRA PEQUENA
JABONERA PEQUENA
SMALL SOAP TRAY
PAG 247



SABONETEIRA GRANDE
JABONERA GRANDE
LARGE SOAP TRAY
PAG 247



TOALHEIRO
TOALLERO
PORCELAIN TOWEL RAIL
PAG 247

NEOCLÁSSICO



CABIDE
PERCHA
HANGER
PAG 248



PORTA PIAÇABA
ESCOBILLERO
TOILET BRUSH HOLDER
PAG 248



PORTA-ROLO
PORTARROLLO
TOILET PAPER HOLDER
PAG 248



VARÃO DE TOALHEIRO
BARRA DE TOALLERO
PORCELAIN TOWEL RAIL
PAG 249



VASSOURA
ESCOBILLA
BRUSH
PAG 248



SABONETEIRA PEQUENA
JABONERA PEQUENA
SMALL SOAP TRAY
PAG 249



SABONETEIRA GRANDE
JABONERA GRANDE
LARGE SOAP TRAY
PAG 249

ALFA



CABIDE
PERCHA
HANGER
PAG 250



PORTA PIAÇABA
ESCOBILLERO
TOILET BRUSH HOLDER
PAG 250



PORTA-ROLO
PORTARROLLO
TOILET PAPER HOLDER
PAG 250

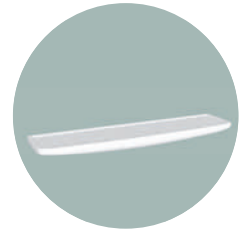

PRATELEIRA
ESTANTE
SHELF
PAG 251



VASSOURA
ESCOBILLA
BRUSH
PAG 250

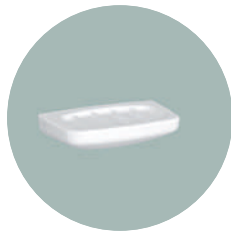

SABONETEIRA PEQUENA
JABONERA PEQUENA
SMALL SOAP TRAY
PAG 251



SABONETEIRA ESPONJEIRA
JABONERA EMPOTRADA
SOAP TRAY AND SPONGE TRAY
PAG 251

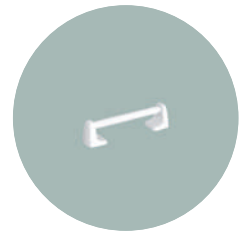

VARÃO DE TOALHEIRO
BARRA DE TOALLERO
PORCELAIN TOWEL RAIL
PAG 252



CABIDE

REF

BRANCO
BLANCO
WHITEPercha
Hanger

24001002

22 €

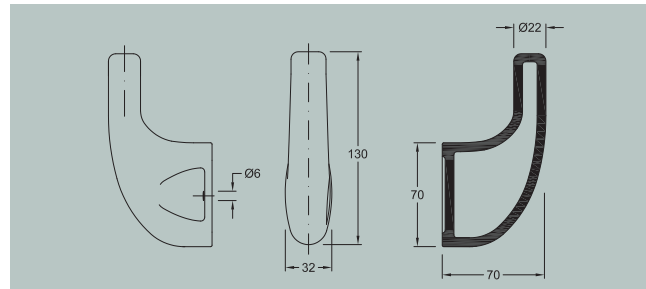

PORTA-PIAÇABA

REF

BRANCO
BLANCO
WHITEEscobillero
Toilet brush holder

24100002

48 €

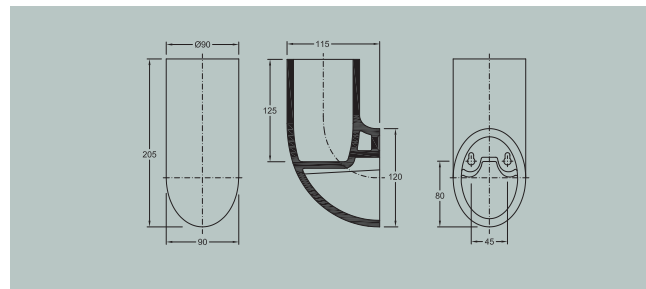

VASSOURA

REF

CROMADO
CROMO
CHROMEEscobilla
Brush

55020005

20 €



PORTA-ROLO

REF

BRANCO
BLANCO
WHITEPortarollo
Toilet paper holder

24200002

32 €

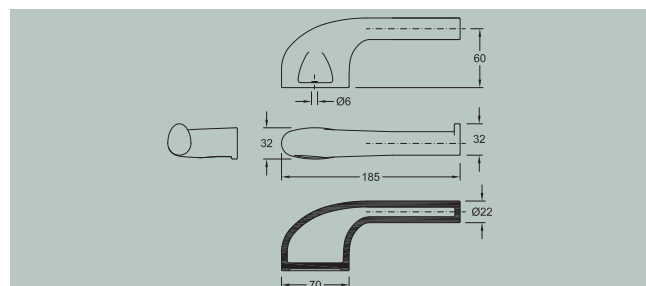

PRATELEIRA

REF

BRANCO
BLANCO
WHITEEstante
Shelf

24350002

52 €

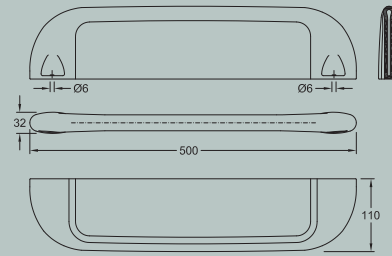

SABONETEIRA PEQUENA

REF

BRANCO
BLANCO
WHITEJabonera pequeña
Small soap tray

24400002

32 €

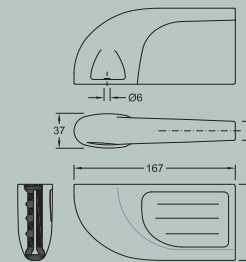

SABONETEIRA GRANDE

REF

BRANCO
BLANCO
WHITEJabonera grande
Large soap tray

24401002

47 €

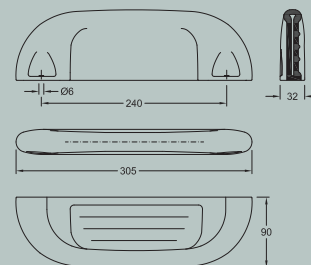

TOALHEIRO

REF

BRANCO
BLANCO
WHITEToallero
Porcelain towell rail

40 cm

24540002

32 €

30 cm

24530002

26 €

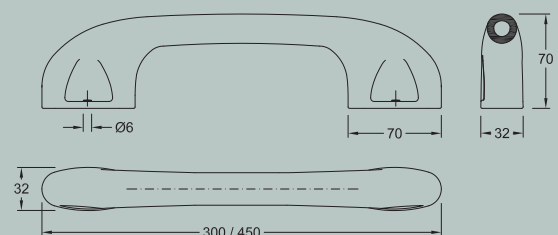

CABIDE

REF

BRANCO
BLANCO
WHITE

Percha
Hanger

26001002

13 €

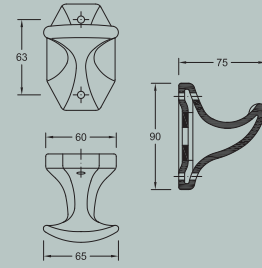

PORTA-PIAÇABA

REF

BRANCO
BLANCO
WHITE

Escobillero
Toilet brush holder

26100002

40 €

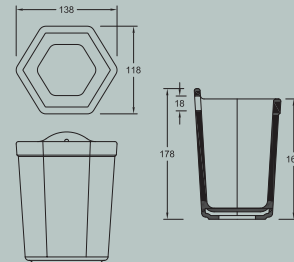

VASSOURA

REF

CROMADO
CROMO
CHROME

Escobilla
Brush

55020005

20 €



PORTA-ROLO

REF

BRANCO
BLANCO
WHITE

Portarollo
Toilet paper holder

26200002

24 €

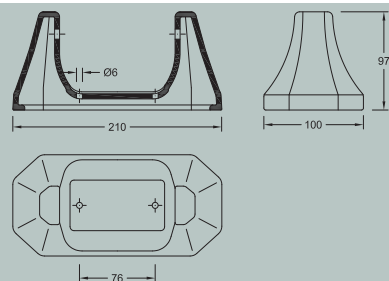

SABONETEIRA PEQUENA

REF

BRANCO
BLANCO
WHITE

Jabonera pequena
Small soap tray

26400002

25 €

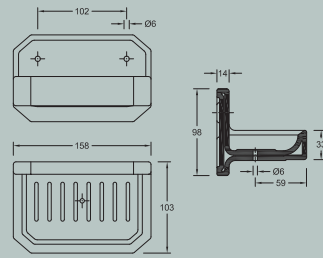

SABONETEIRA GRANDE

REF

BRANCO
BLANCO
WHITE

Jabonera grande
Large soap tray

26404002

41 €

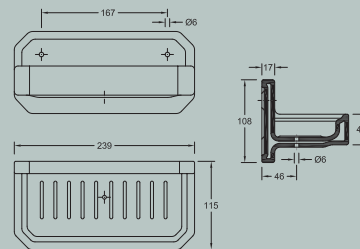

VARÃO DE TOALHEIRO

REF

BRANCO
BLANCO
WHITE

Barra de toallero
Porcelain towel rail

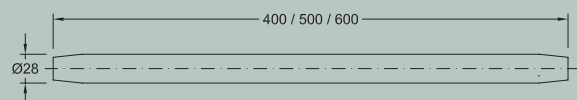

60 cm

22660002

33 €

50 cm

22650002

24 €

40 cm

22640002

23 €

30 cm

22630002

22 €

SUPOORTE P/ VARÃO DE TOALHEIRO

REF

BRANCO
BLANCO
WHITE

Soporte para barra de toallero
Bracket for towel rail

26500002

15 €



CABIDE

REF

BRANCO
BLANCO
WHITEPercha
Hanger

22001002

12 €

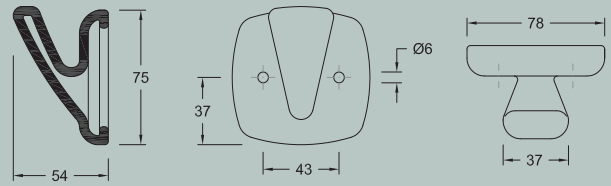

PORTA-PIAÇABA

REF

BRANCO
BLANCO
WHITEEscobillero
Toilet brush holder

22100002

17 €

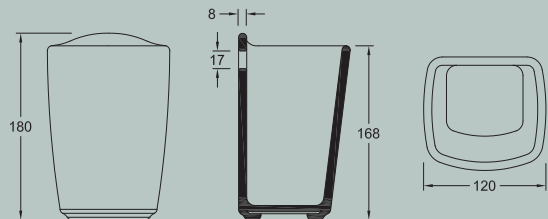

VASSOURA

REF

Escobilla
Brush

55020005

20 €



PORTA-ROLO

REF

BRANCO
BLANCO
WHITEPortarrollo
Toilet paper holder

22200002

17 €

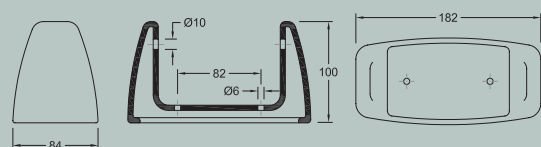

PRATELEIRA

REF

BRANCO
BLANCO
WHITEEstante
Shelf

22360002

41 €

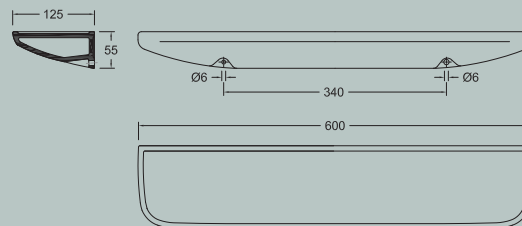

SABONETEIRA PEQUENA

REF

BRANCO
BLANCO
WHITEJabonera pequeña
Small soap tray

22400002

20 €

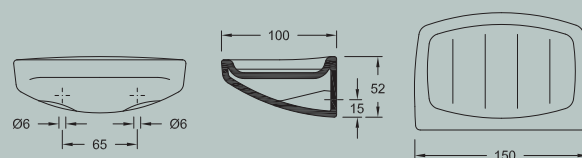

SABONETEIRA ESPONJEIRA

REF

BRANCO
BLANCO
WHITEJabonera empotrada
Soap tray and sponge tray

22401002

48 €

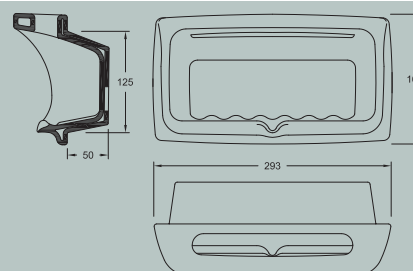

VARÃO DE TOALHEIRO

REF

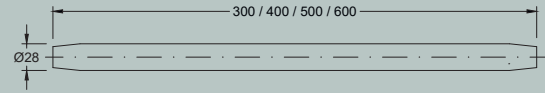
BRANCO
BLANCO
WHITEBarra de toallero
Porcelain towel rail

60 cm

22660002

33 €

50 cm

22650002

24 €

40 cm

22640002

23 €

30 cm

22630002

22 €

SUPORTE PARA VARÃO DE TOALHEIRO

REF

BRANCO
BLANCO
WHITESoporte para barra de toallero
Brackets for towel rail

22500002

13 €



INTRODUÇÃO

Todas as relações comerciais entre a ARCH, SA e os seus Clientes são reguladas pelas seguintes "condições gerais de Venda" que conjuntamente com as "condições gerais de Pagamento" consideram-se integralmente aceites pelo comprador no ato da encomenda.

1. Catálogos, ofertas e encomendas

- 1.1 Todas as indicações e características constantes do material publicitário e informativo estão sujeitas às tolerâncias definidas pelas normas de regulamentação interna de acordo com o normativo do setor.
- 1.2 Qualquer encomenda realizada à ARCH,SA deverá ser realizada em formato escrito, com devida identificação do Cliente, data e descrição técnica suportada nas nossas referências de artigo.
- 1.3 Todas as encomendas serão, para todos os efeitos, passíveis de confirmação por escrito por parte do Cliente.
- 1.4 Qualquer condição estipulada pelo Cliente nos seus pedidos e que não esteja em conformidade com as presentes "condições gerais de Venda" bem como "condições gerais de Pagamento" serão consideradas sem efeito, com posterior confirmação escrita, pela ARCH, SA.

2. Suspensão das Encomendas

2.1 A ARCH, SA reserva o direito de suspender a execução de qualquer encomenda nos seguintes casos:

- Quando o Cliente não tiver dado cumprimento parcial ou total a contratos anteriores;
- Quando por parte do Cliente se verificar recusa na recepção de encomendas após carga e expedição conforme prévia encomenda,
- Sempre que se verifique conduta indevida do Cliente em prejuízo da ARCH, SA.

3. Entregas

- 3.1 Os prazos de entrega são acordados entre a ARCH, SA e o Cliente no decurso da encomenda. Se nada for formalmente estipulado entre as partes, o prazo de referência para entrega será de 30 dias úteis. Sempre que não for possível garantir um prazo acordado, a ARCH, SA compromete-se a avisar o Cliente e a combinar um novo prazo.
- 3.2 Toda e qualquer encomenda poderá ser executada por entregas parciais.
- 3.3 Os artigos e mercadorias consideram-se entregues ao Cliente no momento da carga do meio de transporte deste e a respectiva guia de remessa assinada pelo operador do transporte quando este é da responsabilidade do Cliente. Nestes casos não serão aceites reclamações posteriores por faltas ou dano em mercadoria entregue.
- 3.4 Sempre que a mercadoria é entregue em transporte da responsabilidade da ARCH, SA, esta considera-se entregue quando da validação de recepção de mercadoria no destinatário.
- 3.5 O acto de recepção da mercadoria por parte do Cliente implica a confirmação do conteúdo e conformidade da mesma de acordo com encomenda efectuada e/ou com documentos comprovativos de transporte. Qualquer anomalia deverá ser registada em Guia de remessa da ARCH, SA bem como na Guia de transporte.
- 3.6 Caso não seja possível verificar mercadoria no momento da entrega, o Cliente deverá assinalar nas Guias de Remessa e Transporte a referência "Sujeito a conferência". Qualquer anomalia verificada deverá ser comunicada por escrito pelo Cliente aos nossos serviços comerciais em tempo útil e nunca superior a 5 dias úteis à data da recepção da mercadoria.
- 3.7 A ARCH, SA poderá recusar-se a efectuar o transporte de mercadoria sempre que :
 - O local de destino não seja o armazém do Cliente ou local definido no momento da encomenda.
 - O volume da encomenda não o justifique
 - Sempre que houver recusa de recepção de mercadoria sem motivos imputáveis à ARCH,SA., sendo nesse caso debitado ao Cliente o valor relativo ao transporte e a custos adicionais decorrentes dessa condição.
 - A ARCH, SA reserva-se o direito de considerar sem efeito toda a encomenda que aguarde mais de 30 dias após sua execução nas nossas instalações, sem que o Cliente proceda ao seu levantamento.

4. Preços

- 4.1 Os preços praticados são os constantes da tabela de preços da ARCH, SA em vigor no momento da expedição.
- 4.2 A Tabela de preços poderá ser alterada sem qualquer aviso prévio.
- 4.3 Em caso de publicação e divulgação de nova Tabela de Preços e no prazo de 8 dias úteis seguintes à sua divulgação, o Cliente poderá anular, por escrito, qualquer encomenda ainda não executada ou expedida pela ARCH, SA.
- 4.4 Consideram-se aceites pelos Clientes os preços constantes da nova tabela para as encomendas em curso e que não tenham sido objecto de anulação.
- 4.5 Os preços constantes da Tabela de Preços serão sempre líquidos de impostos em vigor, os quais serão devidamente discriminados em documentos de facturação.
- 4.6 Os preços constantes da Tabela de Preços serão acrescidos de despesas efectuadas com expedição e transporte da mercadoria e / ou embalagem especial quando solicitado pelo Cliente e aceite pela ARCH, SA.

5. Pagamentos

- 5.1 O pagamento das facturas rege-se pelas "Condições Gerais de Pagamento" da ARCH, SA em vigor à data da expedição.
- 5.2 Se o Cliente se constituir em mora, a ARCH, SA reserva-se o direito de suspender a execução de encomendas em curso de processamento ou recebidas entretanto.
- 5.3 Sempre que a ARCH, SA tomar conhecimento de factos e circunstâncias que originem fundado receio de incumprimento de obrigações por parte do Cliente, poderá suspender o processamento e entrega de encomendas efectuadas, salvo mediante garantias fundamentadas do Cliente que honrará os seus compromissos de pagamento em prazo acordado e aceite pela ARCH, SA

6. Garantia de Artigos Cerâmicos

- 6.1 A ARCH, SA dá garantia de 20 anos sobre todos os artigos cerâmicos Sanitários da sua conceção e produção, considerando a data de venda.
- 6.2 Os artigos que durante este período apresentem algum problema técnico ou de qualidade evidente e da responsabilidade da ARCH, SA, serão substituídos sem custos para o Cliente.
- 6.3 Para que a garantia seja ativada, é imprescindível que os defeitos sejam comunicados por escrito aos serviços comerciais da ARCH, SA, acompanhados dos respetivos documentos comprovativos da venda e entrega por parte da ARCH, SA para devida comprovação de origem e data de entrega.

6.4 A aceitação da reclamação será condicionada por validação técnica dos nossos serviços técnicos, para despistagem de causas não cobertas pela garantia aqui descrita, como uso indevido, deficiente instalação ou manutenção, danos de transporte, manipulações, reparações ou alterações efetuadas por terceiros, sem o nosso consentimento escrito.

6.5 A garantia sobre produtos cerâmicos por nós concebidos e produzidos, exclui toda e qualquer responsabilidade decorrente de consequências relativas a incompatibilidade técnica de instalações do Cliente, más condições de operação da instalação, assim como condições indevidas de armazenamento ou manuseamento e não aceitaremos nenhuma reclamação por despesas com as mesmas, assim como responsabilidades legais por danos ou prejuízos.

6.6 O material reclamado será repostado pela ARCH, SA no mais curto espaço de tempo e de acordo com a disponibilidade de material igual ao reclamado.

7. Garantia de componentes não cerâmicos

7.1 A ARCH, SA garante por período de 3 anos, desde a data de compra (comprovada), os produtos não cerâmicos por si comercializados e a seguir discriminados:

- Componentes dos mecanismos de descarga: Válvulas, vedantes, tanques.
- Componentes das Sanitas: Sistemas de fixação, tampos, tubos de descarga
- Componentes dos Bidés: Torneiras, válvulas, tampo, e fixação
- Componentes de Lavatórios: Torneiras, válvulas, fixações.

7.2 Para que a presente garantia seja válida, os equipamentos deverão ser instalados de acordo com as nossas instruções técnicas de montagem e operação.

7.3 A presente garantia não cobre reclamações que resultem de uso indevido, desgaste prematuro por condições de utilização não destinadas à sua configuração ou funcionalidade, alterações realizadas por terceiros, manutenção negligente, desadequação às instalações do Cliente.

8. Reclamações

8.1 Todas as reclamações relacionadas com a entrega de mercadorias (quebras, erros quantidade, faltas, etc) terão de ser efectuadas por escrito para os nossos serviços comerciais num período máximo de 5 dias úteis a contar da data (confirmada) de receção.

8.2 Qualquer reclamação de discordância de preços ou descontos praticados na fatura deverá ser efectuada por escrito para serviços comerciais até 15 dias após a data de receção da mesma.

8.3 Qualquer reclamação técnica ou de qualidade dos nossos produtos e mercadorias, deverá ser comunicada por escrito para os nossos serviços comerciais, com a descrição do problema, peças e quantificação de artigos envolvidos. O Cliente deverá garantir a guarda do material defeituoso até à sua substituição, sem custos para o Cliente, após devido processamento e aceitação de reclamação por parte da ARCH, SA.

8.4 A ARCH, SA procederá de forma a assegurar uma resposta em tempo útil à reclamação de cada Cliente, cujo tempo de resolução estará condicionado pelo processo de análise de causas e a necessária clarificação de responsabilidades.

9. Devoluções

9.1 A ARCH, SA não aceitará qualquer devolução sem a prévia validação escrita do seu departamento Comercial e após devida fundamentação.

9.2 Não serão aceites devoluções de artigos sanitários em modelos e cores que não façam, à data, parte da gama comercializada.

9.3 Mercadorias e componentes não existentes no portfólio comercializado à data ou com tempo de venda superior à garantia comercial.

10. Litígios

10.1 O foro competente para dirimir qualquer litígio emergente das transações comerciais reguladas pelas presentes “condições gerais de Venda” é o da comarca de Vila Nova de Gaia.

10.2 De acordo com a lei n.º 144/2015 de 8 de Setembro, em caso de litígio o cliente pode recorrer ao Centro de Informação de Consumo e Arbitragem do Porto para resolução alternativa de litígios de consumo.

CONDIÇÕES GERAIS DE PAGAMENTO

1. Os fornecimentos a novos Clientes terão de ser liquidados por cheque ou numerário contra entrega da mercadoria. A abertura de crédito só poderá ser concedida após aprovação da Direção Financeira e da Direção Comercial da ARCH, SA.

2. Uma vez acordada a concessão de crédito e estabelecido o plafond respetivo, todas as faturas terão de ser liquidadas a um prazo máximo de 60 dias após a data de emissão.

3. No início de cada mês será emitido um resumo das faturas relativas ao mês anterior.

4. Serão concedidos descontos financeiros de acordo com as condições definidas em contrato com o Cliente ou aplicando regra geral de 2% de desconto financeiro a pronto pagamento.

5. A ARCH, SA reserva o direito de debitar juros compensatórios sempre que não se verifique o cumprimento das condições de pagamento aqui estabelecidas. Em caso algum será aceite como justificação para o não pagamento duma fatura, a existência de situações pendentes relativas a outros fornecimentos.

6. Haverá suspensão de fornecimentos sempre que ocorra uma das seguintes situações:

6.1 Pagamento de mercadorias seja efetuado com cheque sem provisão

6.2 Existam faturas vencidas por liquidar sem uma devida justificação

6.3 O plafond de crédito concedido tenha sido ultrapassado.

7. A nenhum Cliente com crédito suspenso será satisfeito qualquer encomenda, mesmo que o novo fornecimento seja contra pronto pagamento.

8. Em caso algum a ARCH, SA aceitará letras como forma de pagamento, mesmo que os encargos fiquem por conta do Cliente.

CONDIÇÕES GERAIS

1. A todos os preços da Tabela de Preços acresce o valor de I.V.A. à taxa em vigor.

2. Os preços da Tabela de Preços podem ser alterados sem aviso prévio.

3. As características e dimensões dos artigos constantes da Tabela de Preços estão sujeitas às 4. tolerâncias técnicas regulamentadas em normas do sector de atividade.

4. Reserva-se o direito de eliminar e alterar referências a artigos e mercadorias comercializadas e constantes da Tabela de Preços.

INTRODUCCIÓN

Todas las relaciones comerciales entre ARCH, S.A. y sus clientes son reguladas por las "condiciones generales de venta" que junto las "condiciones generales de pago" se consideran aceptadas integralmente por el comprador en el momento de la compra.

1. Catálogos, ofertas y pedidos

1.1 Todas las indicaciones y características que constan en la publicidad y material informativo están sujetas a las tolerancias establecidas por las reglas internas en conformidad con las normas del sector.

1.2 Cualquier pedido realizado a ARCH, S.A. se tendrá que hacer por escrito, con la debida identificación del cliente, fecha y descripción técnica conforme las referencias del producto.

1.3 Todos los pedidos serán para los debidos efectos sujetos a confirmación por escrito de la parte del cliente.

1.4 Cualquier condición estipulada por el cliente en sus pedidos y que no esté conforme con las presentes "condiciones de venta" así como en las "condiciones generales de pago" se considerarán sin efecto y serán confirmadas por escrito por ARCH, S.A. con posterioridad.

2. Cancelación de pedidos

2.1 ARCH, SA se reserva el derecho de cancelar un pedido en los siguientes casos:

- Cuando hubiera incumplimiento parcial o total de contratos anteriores.
- Cuando el cliente se niega a recibir la mercancía después de la expedición de la misma y mediante previa confirmación del pedido.
- Siempre que se constate un comportamiento indebido en detrimento de ARCH, S.A.

3. Entregas

3.1 Los plazos de entrega se definen entre ARCH, SA y el cliente durante el transcurso del pedido. Si no hubiera nada estipulado el plazo de referencia para la entrega es de 30 días laborables. Si no fuese posible garantizar un plazo estipulado, ARCH, S.A. se compromete a avisar el cliente con un nuevo plazo.

3.2 Todos los pedidos se podrán satisfacer mediante entregas parciales.

3.3 Todos los productos y mercancías que se hayan recogido a través del transporte del cliente se considerarán como entregados en el momento de su carga mediante la firma del albarán por el correspondiente conductor siempre y cuando la responsabilidad del transporte recaiga en el cliente. En estos casos no se aceptarán reclamaciones a posteriori sea por faltas o daños.

3.4 Cuando la responsabilidad del transporte recaiga en ARCH, S.A. la mercancía se considerará como entregada en el momento de la firma del albarán en el destino acordado.

3.5 El acto de recepción de la mercancía por parte del cliente implica la confirmación de su contenido y consecuente conformidad de acuerdo con el pedido efectuado y/o con los documentos del transporte que lo comprueben. Cualquier anomalía se deberá registrar en el albarán de ARCH, S.A. y en el respectivo documento de transporte.

3.6 En el caso que no se pueda comprobar la mercancía en el acto de entrega, el cliente tendrá que hacer referencia en el albarán y documento de transporte el siguiente comentario "sujeto a confirmación". Cualquier anomalía deberá ser comunicada por el cliente por escrito para nuestros servicios comerciales en tiempo útil y nunca superior a 5 días laborables después de la recepción de la mercancía.

3.7 ARCH, SA se puede negar a realizar un transporte de la mercancía en las siguiente circunstancias:

- Cuando el destino no sea el almacén del cliente o el local de entrega estipulado en el pedido.
- Cuando la cantidad pedida no lo justifique.
- Si el cliente se recusa a descargar la mercancía por motivos no imputables a ARCH, S.A. en cuyo caso se procederá al cargo del transporte y demás costes adicionales que puedan surgir como consecuencia de ese acto.
- ARCH, SA se reserva el derecho de considerar sin efecto todo pedido que quede en espera más de 30 días después de su disponibilidad sin que el cliente proceda a la respectiva recogida

4. Precios

4.1 Los precios practicados son los que constan en la tarifa de ARCH, S.A. en vigor en el momento de la expedición.

4.2 Se podrá alterar la tarifa sin previo aviso.

4.3 El cliente podrá anular en un plazo de 8 días laborables posteriores a la publicación de la nueva tarifa, cualquier pedido en curso no efectuado o expedido por ARCH, S.A

4.4 Los pedidos en curso que no hayan sido anulados después del tiempo transcurrido para ese efecto tendrán como base los nuevos precios.

4.5 Los precios que constan en la tarifa serán siempre antes de los impuestos en vigor y los cuales aparecerán en las respectivas facturas.

4.6 Los precios de tarifa podrán sufrir un aumento según eventuales costes de expedición, transporte y/o embalaje especial que sean solicitados por el cliente y aceptados por ARCH S.A.

5. Pagos

5.1 El pago de facturas se rige por las "condiciones Generales de Pago" de ARCH, S.A. en vigor a la fecha de expedición.

5.2 Si el Cliente entra en mora, ARCH, SA se reserva el derecho de suspender los pedidos pendientes de servicio.

5.3 Siempre que ARCH, S.A. tome conocimiento de hechos y circunstancias que puedan originar un incumplimiento por parte del cliente, esta podrá suspender los pedidos en curso salvo mediante la presentación de garantías de pago fidedignas por parte del cliente y que sean previamente aprobadas por ARCH, S.A.

6. Garantía de Productos cerámicos

6.1 ARCH, S.A ofrece una garantía de 20 años sobre todos los artículos cerámicos Sanitarios de su autoría a partir de la fecha de venta.

6.2 Los artículos que durante ese período presenten algún problema técnico o de calidad evidente serán substituidos sin cualquier coste para el cliente y desde que sea responsabilidad de ARCH, S.A.

6.3 Es imprescindible que los defectos sean comunicados por escrito a los servicios comerciales de ARCH S.A. para que se produzca la activación de la mencionada garantía. Esa comunicación deberá ir acompañada de los documentos comprobantes de la venta y entrega por ARCH, S.A. para efectos de verificación de origen y fecha de entrega.

6.4 La aceptación de la reclamación estará condicionada por la validación técnica de nuestros servicios técnicos para un apuramiento de eventuales causas que puedan estar fuera de la cobertura de la garantía como el uso indebido y deficiente de la instalación o mantenimiento, desperfectos en el transporte, manipulaciones, reparaciones o alteraciones efectuadas por terceros sin un previo acuerdo o consentimiento por escrito.

6.5 La garantía sobre los productos cerámicos concebidos y producidos por ARCH, S.A. excluye toda y cualquier responsabilidad que transcurra de consecuencias relativas a la incompatibilidad técnica de las instalaciones del cliente, malas condiciones de operatividad

de las instalaciones, así como condiciones indebidas de almacenaje o manejo y no se aceptará ninguna reclamación por gastos con las mismas así como responsabilidades por daños y perjuicios.

6.6 Se repondrá el material reclamado en el espacio de tiempo más breve posible y de acuerdo con la disponibilidad del material igual al reclamado.

7. Garantía de componentes no cerámicos

7.1 ARCH, SA garantiza por un período de 3 años, desde la fecha de compra (comprobada), los productos no cerámicos que se siguen:

- Componentes de los mecanismos de descarga: Válvulas, aislantes, tanques.
- Componentes de los inodoros: Sistemas de fijación, tapas, tubos de descarga
- Componentes de los Bidés : Grifos, válvulas, tapas, y fijación
- Componentes de los lavabos: Grifos, válvulas, tapas, y fijaciones.

7.2 Para que la presente garantía sea válida, los equipos deberán ser instalados de acuerdo con nuestras instrucciones técnicas de montaje y operación.

7.3 La presente garantía no cubre reclamaciones que resulten del uso indebido, desgaste prematuro por condiciones de utilización no destinadas a su configuración o funcionalidad, alteraciones realizadas por terceros, mantenimiento negligente o inadaptación a las instalaciones del cliente.

8. Reclamaciones

8.1 Todas las reclamaciones relacionadas con la entrega de mercancías (quebras, errores de cantidad, faltas etc.) se tendrán que efectuar por escrito a nuestros servicios comerciales en un tiempo máximo de 5 días laborables a partir de la fecha (comprobada) de entrega.

8.2 Cualquier reclamación sobre la disputa de precios o descuentos constantes en la factura se tendrá que efectuar por escrito hasta 15 días después de la recepción de la misma.

8.3 Se deberá comunicar por escrito para nuestros servicios comerciales cualquier reclamación técnica o de calidad de nuestros productos y mercancías con la descripción del problema, piezas y cuantificación de los artículos en cuestión. El cliente deberá garantizar el almacenaje del material defectuoso hasta su substitución, sin costes para el, y solamente después de la aceptación previa por parte de ARCH, S.A de la respectiva reclamación.

8.4 A ARCH, S.A siempre procederá de manera a dar una respuesta a la reclamación de cada cliente en tiempo útil y cuya solución dependa de las causas y el apuramiento de responsabilidades.

9. Devoluciones

9.1 ARCH, S.A. no aceptará cualquier devolución sin la aceptación previa por escrito del departamento comercial y mediante la debida fundamentación.

9.2 No se aceptarán devoluciones de artículos sanitarios cuyos modelos y colores no hagan parte de la gama actual en comercialización.

9.3 No se aceptarán mercancías y componentes que no existan en la gama comercializada presentemente o con tiempo de venta superior a la garantía comercial.

10. Litigios

10.1 El fuero competente para dirimir cualquier litigio resultante de las transacciones comerciales reglamentadas por las presentes "condiciones generales de venta" es el de la comarca de Vila Nova de Gaia.

10.2 De acuerdo con la Ley n° 144/2015 del 8 de Septiembre, en caso de litigio el cliente puede recurrir al " Centro de Informação de Consumo e Arbitragem" de Porto para una resolución alternativa de litigios al consumo.

CONDICIONES GENERALES DE PAGO

1. Los suministros de nuevos clientes se tendrán que pagar mediante cheque o en efectivo al entregar la mercancía. La apertura de crédito solamente se podrá efectuar mediante la aprobación previa de la dirección Financiera y Comercial de ARCH, S.A.

2. Una vez que se aprueba la apertura de crédito y el respectivo límite, todas las facturas tendrán que ser liquidadas pasados 60 días de la fecha de emisión de las mismas.

3. Al inicio de cada mes se emitirá un resumen de las facturas del mes anterior.

4. Los descuentos financieros se concederán de acuerdo con las condiciones especificadas en el contrato de cada cliente o aplicando la regla general del 2% de descuento a pronto pago.

5. ARCH, SA se reserva el derecho a cobrar intereses de demora siempre y cuando no se verifiquen las condiciones de pago aquí establecidas. En ninguna circunstancia se aceptará como justificación del impago la existencia de situaciones pendientes relativas a otros suministros.

6. Habrá suspensión de suministros siempre que ocurra una de las siguientes situaciones:

6.1 Pago de mercancías con un cheque sin fondo.

6.2 Existencia de facturas en atraso sin la debida justificación.

6.3 Alcanzar el Límite de crédito.

7. No habrá nuevo suministro una vez que el crédito se encuentre anulado aún cuando el nuevo suministro sea a pronto pago.

8. En ningún caso se aceptarán letras de cambio como forma de pago aun cuando los gastos corran por cuenta del cliente.

CONDICIONES GENERALES

1. Los precios en la tarifa no incluyen el IVA.

2. Los precios en la tarifa pueden sufrir alteraciones sin previo aviso.

3. Las características y dimensiones de los artículos que figuran en la tarifa se someterán a las tolerancias técnicas especificadas en las respectivas normas del sector.

4. Se reserva el derecho de eliminar o alterar referencias a artículos y mercancías constantes en la tarifa.

INTRODUCTION

All commercial relations between ARCH, SA and its Clients are ruled by the following "General Terms of Sale" which, together with the "General Terms of Payment" are deemed to have been fully accepted by the purchaser at the time its order is made.

1. Catalogues, offers and orders

1.1 All indications and characteristics stated in our advertising material are subject to the tolerances defined in the Quality Assurance System in accordance with the standards in force for the sector.

1.2 Any order to ARCH, SA shall be made in writing by way of a duly numbered requisition on company headed paper, date and technical description on our catalogue references.

1.3 To all intents and purposes, all orders are subject to acceptance in writing.

1.4 Any condition stipulated by the Client in its requests which does not conform to the present "General Terms of Sale" or to the "General Terms of Payment" shall be deemed null and void, unless subsequently confirmed in writing by ARCH, SA.

2. Suspension of orders

2.1 ARCH, SA reserves the right to suspend the execution of any order in the following cases:

- When the Customer has not given partial or full compliance with previous contracts;
- When by the Customer to check refuses to receive their orders after loading and dispatch as prior order,
- Where there is Customer misconduct to the detriment of ARCH, SA.

3. Deliveries

3.1 The delivery dates are agreed upon between ARCH, SA and its Clients. Should nothing be formally stipulated by both parties, the delivery date to be assumed shall be

of 30 days. Whenever this cannot be met, ARCH, SA undertakes to notify the Client and agree upon a new date.

3.2 Any order may be carried out through partial deliveries.

3.3 The goods are deemed to have been delivered to the Client as soon as their loading onto the truck has been completed at ARCH, SA warehouse and the respective Delivery Slip has been signed by the driver, with transport being wholly the responsibility of the Client meaning that, in such cases, no complaints shall be accepted owing to the breakage of material or goods missing.

3.4 Whenever transport is carried out in transport chartered by ARCH, SA the goods shall be deemed to have been delivered upon their receipt at the destiny.

3.5 The Client shall verify upon receipt whether the products correspond to those ordered by it. Any irregularity shall be registered on ARCH, SA Delivery Slip as well as on the Transporter Slip.

3.6 Should it not be possible to verify the goods upon delivery, the Client shall write on the corresponding Delivery Slips and on the Transporter Slip "Subject to Conferral". Any irregularity detected shall be communicated to our commercial services in writing within no more than 5 days

3.7 ARCH, SA may refuse to transport orders whenever:

- The place of destination is not the Client's warehouse or that agreed upon previously;
- The volume of the order does not so justify.
- Whenever there is a refusal to receive, for reasons not attributable to ARCH, SA, the Client shall be charged an amount corresponding to the value of transport.
- ARCH, SA reserves the right to deem null and void any order remaining over 30 days after it was made without the Client having collected it.

4. Prices

4.1 The prices charged are always those set out in the Price Table of ARCH, SA in force at the time of dispatch of the goods.

4.2 The Price Table may be altered without any prior notice.

4.3 Owing to the coming into force of the new Price Table of ARCH, SA, and within eight days after its disclosure, the Client may cancel, in writing, any order yet to be implemented or dispatched by ARCH, SA.

4.4 In case of projects in study with deliveries scheduled for the coming year, the proposed prices shall have the validity of the budget even if some change in the price list occurs in that period.

4.5 The prices set out in the table shall be deemed to have been accepted by the Clients whenever their orders have not been subject to cancellation in accordance to the point.

4.6 The prices stated in the Table are always net of the taxes in force which shall always be itemised on the invoices.

4.7 Any expenses defrayed on dispatching goods in special packaging shall accrue to the prices stated in this price list whenever said packaging is requested by the Client and accepted by ARCH, SA.

5. Payments

5.1 The payment of invoices is subject to the "General Terms of Payment" of ARCH, SA in force as at the date of dispatch.

5.2 If the Client is late in making payment, ARCH, SA reserves the right to suspend the implementation and dispatch of any orders in portfolio.

5.3 Whenever ARCH, SA learns of any facts and circumstances which cause well-founded fears of breaches in compliance with obligations by the Client, it may suspend the delivery of goods, unless the purchaser provides guarantees in a timeframe to be agreed upon.

6. Guarantee of ceramic components

6.1 ARCH, SA gives guarantee of 20 years from buying date to all ceramic products conceived and produced by them.

6.2 All the ceramic wares that during this period show any problem due to any material defect or manufacturing one will be replaced to the customer for free.

6.3 In order to activate the guarantee it is necessary that all defects are communicated immediately by written to ARCH, SA, together with invoice or other document issued by us proving the origin and delivery date of the product.

6.4 The acceptance of the claim shall be conditioned by our Quality Department to verify causes non covered by this guarantee such as negligence, bad installation and/ or maintenance, transport damages, handling, repairs or intervention done by third parties without our Previous written permission.

6.5 The guarantee about ceramic products conceived and produced by ARCH, SA exclude all and any responsibility coming from technical

incompatibility of Client premises, bad conditions of installing process, and also improper storage or handling conditions. ARCH, SA shall not accept any claim of expenses occurred from those referred situations as well as legal responsibility for damages or prejudices.

6.6 The claimed material will be replaced by ARCH, SA in the shortest period and according to the availability of such material.

7. Guarantee of non ceramic components

7.1 A ARCH,SA grants 3 years guarantee from buying date (duly proved) on the bellow non-ceramic products:

- Discharge Mechanisms components: Valves, sealant system and plastic cisterns;
- WC components: Seats, fixation systems and discharge pipes;
- Bidet components: Taps, valves, seats and fixation systems;
- Washbasins components: Taps, valves and fixation systems.

7.2 This Guarantee comes in force always and when all the proceedings written on installation manual have been followed (if applicable).

7.3 The present guarantee does not cover claims occurring from the misuse, premature deterioration for usage conditions not designated to its configuration or functionality, changes done by third parties, negligent maintenance, inadequate to client's premises.

8. Claims

8.1 As specified in 3.1 all claims related to the delivery of products (breaks, quantity errors, failures, etc) must be made in writing to Commercial Department within a period of 5 days from the date of receipt of the same.

8.2 Any claim owing to a disagreement over the prices or discounts made to the invoice shall be lodged in writing to Commercial Department within 15 days after receipt thereof.

8.3 Any technical or quality claim of our products must be communicated by written to our Commercial services with full description of the problem, pieces and quantification. The client must guarantee to keep the materials properly until its replacement after verification and acceptance of the claim by ARCH, SA.

8.4 ARCH, SA shall assure a reply in appropriate time to each Client claim, which resolution time shall be conditioned by the confirmation of responsibilities.

9. Returns

9.1 ARCH, SA will not accept any return without the prior authorisation in writing of its Commercial Department.

9.2 Under no circumstances shall returns be accepted of sanitary ware in models or colours which do not, to date, form part of the current range

9.3 All products and components non existent in the catalogue to date or with selling date superior to commercial guarantee.

9.4 The charges with the return process of all the products shall be on the Clients responsibility.

10. Disputes

10.1 The competent venue for settling any litigation arising out of the commercial transactions regulated by the present "General Terms of Sale" is the District of Vila Nova de Gaia.

10.2 According to Law No. 144/2015 of September 8, in the event of litigation the customer may use the Consumer Information and Arbitration Center of PORTO for alternative resolution of consumer disputes

GENERAL TERMS OF PAYMENT

1. Supplies to new Clients must be paid upon delivery of goods. Credit shall only be granted after approval of the Financial Management and the Commercial of ARCH, SA.

2. Once it has been agreed to grant credit and the respective limit has been established, all invoices must be settled within 60 days after the date of the respective issue.

3. At the start of each month a summary of invoices shall be issued relating to the previous month.

4. A prompt payment discount shall be granted (in cheque, cash or bank transfer) with order acceptance, or with payment in the delivery date, or by payment at loading date, or by financial discount with payment till 15 days after invoice date, according personalized conditions.

5. ARCH, SA has the right to cancel given discounts all the time the terms of payment previously established are not fulfilled.

6. Supplies shall be suspended in the event of any of the following situations:

6.1 The payment of the goods and/or costs has been made with a bouncing cheque;

6.2 There are documents due and unpaid without proper justification;

6.3 The credit plafond assigned has been exceeded.

7. Any Client whose credit has been suspended cannot make an order even if prompt payment is made

8. In any case, ARCH, SA shall accept bill of exchanges as payment, even with charges on client's account.

GENERAL CONDITIONS

1. All prices in the price list are subject to vat at the legal rate in force.

2. Prices may be changed without prior notice.

3. The characteristics and measurements shown are subject to some technical tolerances, according to the norms of this activity sector.

4. We reserve the right to alter and/or eliminate products shown in this price list

5. The commercialisation of the aforementioned products is subject to the general terms of sale and payment set out in this price list.

SEDE / FÁBRICA | HEADQUARTERS/ FACTORY

Av. António Coelho Moreira
4405-528 Vila Nova de Gaia
Portugal

+351 223 238 038
comercial@archvaladares.com

www.archvaladares.com
www.arch.pt